



**Designing,  
producing,  
lighting up**  
since 1989

**Projektujemy,  
produkujemy,  
oświetlamy**  
od 1989 roku

# 2017

**LED profiles**  
**profile LED**

**TOPMET accessories system**  
**System akcesoriów TOPMET**

## COVERS KLOSZE

- A** slide / wsuwany  
white, frosted, transparent  
mleczny, szron, transparentny
- B** slide / wsuwany  
white, frosted, transparent  
mleczny, szron, transparentny
- C** click / klik  
white, transparent  
mleczny, transparentny
- C** lens / soczewka  
transparent  
transparentny
- D** click / klik  
white  
mleczny
- E** slide / wsuwany  
white, frosted, transparent  
mleczny, szron, transparentny
- F** click / klik  
white, transparent  
mleczny, transparentny
- G** slide / wsuwany  
white, frosted, transparent  
mleczny, szron, transparentny
- H** slide / wsuwany  
white, frosted, transparent  
mleczny, szron, transparentny
- I** click / klik  
white, frosted  
mleczny, szron
- J** slide / wsuwany  
white, frosted, transparent  
mleczny, szron, transparentny
- K** click / klik  
white  
mleczny

## MOUNTINGS MOCOWANIA

- T**  
**T mounting plate**  
uchwyt **T**
- T connector**  
łącznik **T**
- U**  
**U flexible mounting plate**  
uchwyt **U** sprężysty
- cone U flexible mounting plate**  
uchwyt **U** sprężysty  
cone
- rack U flexible mounting plate**  
uchwyt **U** sprężysty  
rack
- W**  
**cone W flexible mounting plate**  
uchwyt **W** sprężysty  
cone
- white, inox, black  
biały, inox, czarny
- X**  
**X mounting plate**  
uchwyt **X**
- X connector**  
łącznik **X**
- Y**  
**Y flexible mounting plate**  
uchwyt **Y** sprężysty
- cone Y flexible mounting plate**  
uchwyt **Y** sprężysty  
cone
- Z**  
**Z flexible mounting plate**  
uchwyt **Z** sprężysty
- white, inox, black  
biały, inox, czarny
- cone Z flexible mounting plate**  
uchwyt **Z** sprężysty  
cone
- white, inox, black  
biały, inox, czarny



**TOPMET<sup>®</sup>**

**2017**

**LED profiles**  
**profile LED**



## TOPMET LED profiles

profile LED TOPMET

Tutorial / Krok po kroku ..... 1.1



## surface LED profiles

profile LED nawierzchniowe

<b>SLIM8 A/Z</b> .....	2.1
<b>SMART10 A/Z</b> .....	2.5
<b>SURFACE10 BC/UX</b> .....	2.9
<b>BEGTON12 J/S</b> .....	2.13
<b>UNI12 BCD/U</b> .....	2.17
<b>SURFACE14 EF/TY</b> .....	2.21
<b>LINEA20 EF/TY</b> .....	2.25
<b>WIDE24 G/W</b> .....	2.33

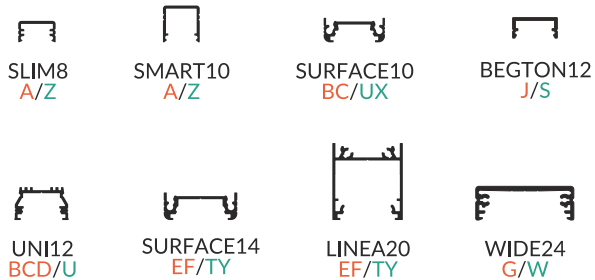

## recessed LED profiles

profile LED wpustowe

<b>FLAT8 H/UX</b> .....	3.1
<b>DEEP10 BC/UX</b> .....	3.5
<b>GROOVE10 BC/UX</b> .....	3.9
<b>SMART-IN10 A/Z</b> .....	3.13
<b>BEGTIN12 J/S</b> .....	3.17
<b>FLOOR12 K/U</b> .....	3.21
<b>GROOVE14 EF/TY</b> .....	3.25
<b>LINEA-IN20 EF/U7</b> .....	3.29

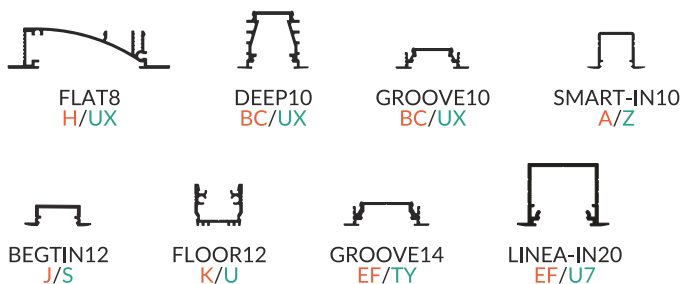

## corner LED profiles

profile LED kątowe

<b>TRIO10 BC</b> .....	4.1
<b>CORNER10 BC/UX</b> .....	4.5
<b>QUARTER10 BD/U6</b> .....	4.9
<b>CABI12 E</b> .....	4.13
<b>CORNER14 EF/TY</b> .....	4.17
<b>CORNER27 G/UX</b> .....	4.21

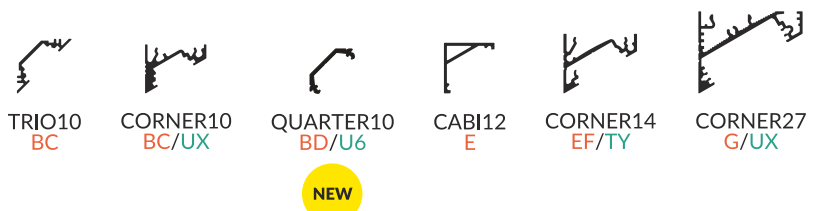

## special application LED profiles

profile LED specjalne

<b>PEN8 I</b> .....	5.1
<b>BACK10 A/UX</b> .....	5.5
<b>STEP10 C</b> .....	5.9
<b>AMBI12 C</b> .....	5.13
<b>ARC12 CD/U5</b> .....	5.17
<b>FIX12 / FIX16</b> .....	5.21
<b>OUTSTAIRS12 BC</b> .....	5.23
<b>WALLE12 BCD</b> .....	5.27
<b>FRAME14 BC/Q</b> .....	5.31
<b>OVAl20 BC</b> .....	5.35

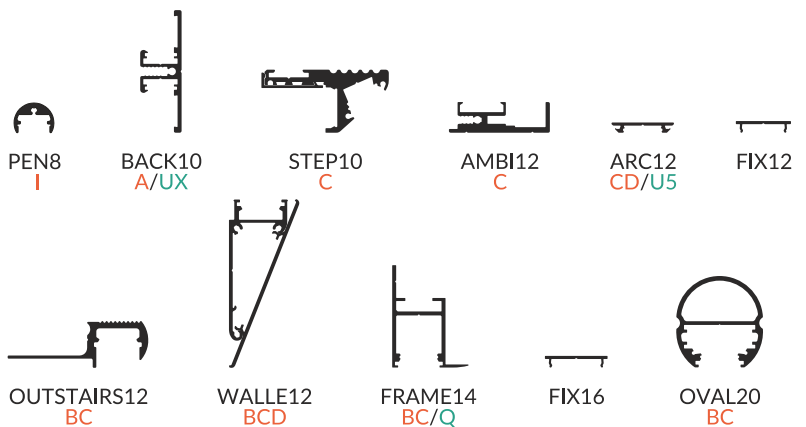

## glass application LED profiles

profile LED do szkła

<b>TWIN8</b> .....	6.1
<b>MIKRO10</b> .....	6.3
<b>EDGE10 BC</b> .....	6.5
<b>MIKRO-LINE12 J</b> .....	6.9



**VARIO30**

## VARIO30

<b>VARIO30-01</b>	1
<b>VARIO30-02</b>	1
<b>VARIO30-03</b>	1
<b>VARIO30-04</b>	1
<b>VARIO30-05</b>	1
<b>VARIO30-06</b>	1
<b>VARIO30-07</b>	1
<b>VARIO30-08</b>	1
<b>VARIO30-09</b>	1
<b>VARIO30-10</b>	1
<b>FIX16</b>	1

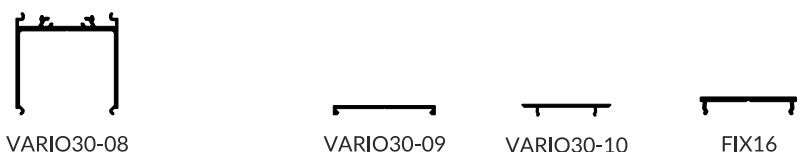
**SURFACE / NAWIERZCHNIOWE****RECESSED - SPACKLE FLANGE MOUNTING  
WPUSTOWE DO SZPACHLOWANIA****RECESSED  
WPUSTOWE****POWER SUPPLY PROFILE  
PROFIL DO ZASILANIA****ASSISTANT PROFILES  
PROFILE POMOCNICZE****big profiles**

## duże profile

<b>PHIL53</b>	8.2
<b>PHIL recessed / PHIL wpust</b>	8.2
<b>LOWI</b>	8.3

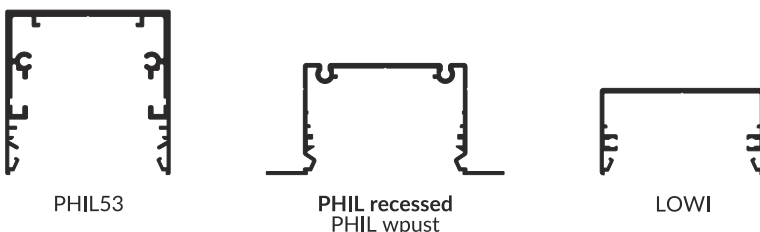
**LED accessories**

## akcesoria LED

<b>PREMIUM LED strips / taśmy LED z serii PREMIUM</b>	9.2
<b>STANDARD LED strips / taśmy LED z serii STANDARD</b>	9.3
<b>BUDGET LED strips / taśmy LED z serii BUDGET</b>	9.3
<b>TOPMET Light PREMIUM LED modules / moduły LED PREMIUM TOPMET Light</b>	9.4
<b>LED power supplies / zasilacze LED</b>	9.5
<b>OSRAM LED power supplies / zasilacze LED OSRAM</b>	9.6
<b>power supply cases / obudowy do zasilaczy</b>	9.7
<b>lighting controllers and switches / czujniki sterujące i włączniki</b>	9.8
<b>RGB lighting system / system oświetlenia RGB</b>	9.10
<b>Vario white lighting system / system oświetlenia Vario white</b>	9.10
<b>LED profile slings / zawiesia do profili LED</b>	9.11
<b>tilted bracket for LED profiles / uchwyty uchylne do profili LED</b>	9.11
<b>cables, extensions, connectors / przewody, przedłużacze, złączki</b>	9.12
<b>other accessories / pozostałe akcesoria</b>	9.13

**general information**

## informacje ogólne

<b>Why LED profiles? / Dlaczego profile LED?</b>	10.1
<b>LED technology / technologia LED</b>	10.3

**sales support**

## wsparcie sprzedaży

<b>Sales support / Wsparcie sprzedaży</b>	11.1
---	------





**TOPMET LED PROFILES - TUTORIAL**  
**PROFILE LED TOPMET - KROK PO KROKU**

**2017**

**LED profiles**  
**profile LED**

# TOPMET profile categories / Kategorie profili TOPMET



## SURFACE / NAWIERZCHNIOWE

LED profiles with the most universal applications. Installation on a flat surface, most commonly with the use of aluminium holders or steel flexible mounting plates but also with the use of screws, or assembly tapes.

It is worth to note the following profiles: SLIM8, SMART10, BEGTON12, WIDE24: Slick socket - easy cover assembly. SURFACE10, SURFACE14, LINEA20: hidden mounting.

Profile LED o najbardziej uniwersalnych zastosowaniach. Montaż na płaskiej powierzchni, najczęściej za pomocą uchwytów aluminiowych lub stalowych sprężystych, ale także wkrętów, taśm montażowych.

Warto zwrócić uwagę na profile: SLIM8, SMART10, BEGTON12, WIDE24: gniazdo Slick – łatwy montaż klosza. SURFACE10, SURFACE14, LINEA20: ukryte mocowanie.



## RECESSED / WPUSTOWE

The advantage of embedding a profile is obtaining an illuminating surface which almost levels with the plane of the wall or furniture. Profile installation requires surface preparation - cutting a longitudinal opening in the furniture (GROOVE10, BEGTIN12, GROOVE14), a plasterboard (FLAT8, DEEP10) or leaving an appropriate distance when installing the tiles (FLOOR12).

Zaletą wpuszczenia profilu jest uzyskanie powierzchni świecącej niemalże licującej się z płaszczyzną ściany lub mebla.

Montaż profili wymaga przygotowania powierzchni – wycięcie podłużnego otworu w meblu (GROOVE10, BEGTIN12, GROOVE14), w płycie gipsowo-kartonowej (FLAT8, DEEP10) lub pozostawienia odpowiedniego dystansu przy montażu płytek (FLOOR12).

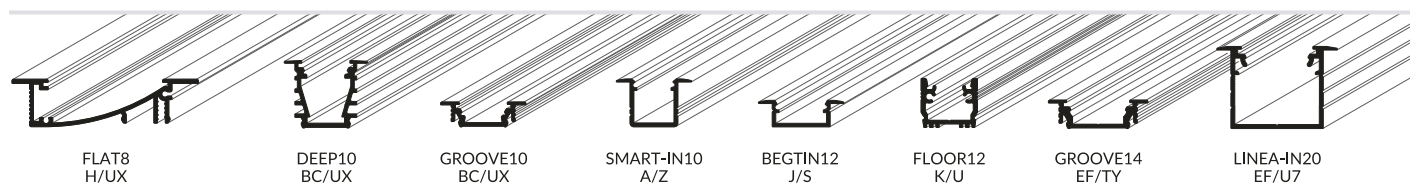

## CORNER / KĄTOWE

To be used in the corners of wall, furniture and cabinets. Installation with mounting plates, screws, assembly tape. The asset of the CORNER10, CORNER14 and CORNER27 collections is the hidden mounting. These profiles provide a possibility to direct the light at an angle of 30° or 60° to the assembly plane. The CABI12 profile is designed for glass cabinets, then adhesive mounted. It allows to avoid glare. Installation at an angle of 30° or 60°. Thanks to the symmetric cross-section, the profiles can be joined in the corners at an angle of 90°. TRIO10 - for lighting at an angle of 45°.

Do zastosowania w narożnikach ścian, mebli i gablot. Montaż na uchwyty, wkręty, taśmę montażową. Atutem kolekcji CORNER10, CORNER14 i CORNER27 jest ukryte mocowanie. Profile te dają możliwość skierowania światła pod kątem 30° lub 60° do płaszczyzny montażu. Profil CABI12 zaprojektowany do szklanych gablot, montowany na klej. Pozwala uniknąć ośnienia. Montaż pod kątem 30° lub 60°. Dzięki symetrycznemu przekrojowi profile można łączyć w narożnikach pod kątem 90°. TRIO10 - do oświetlania pod kątem 45°.

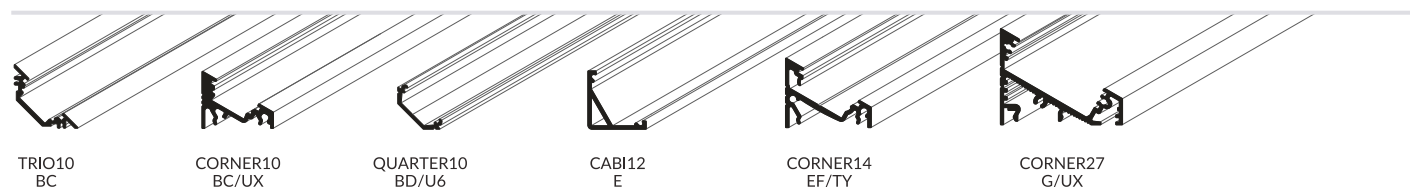





## GLASS APPLICATION / DO SZYB

Profiles for glass are used to exhibit objects in cabinets and to illuminate the sanded advertising or decorative graphics. Installed on the edge of the glass panel, they do not constitute a shelf supporting structure. EDGE10 - in contrast to the other ones - is applied on the face of the shelf, which allows to better light up the exhibits under the shelf or above it (after rotating the profile by 180°).

Profile do szyb służy do ekspozycji przedmiotów w gablotach, podświetlają wypiszkowaną grafikę reklamową lub ozdobną. Montowane na krawędzi szklanej tafli, nie stanowią jednak konstrukcji podtrzymującej półki. EDGE10 – w przeciwieństwie do pozostałych – nakłada się od czoła półki, co pozwala lepiej oświetlić eksponaty pod półką lub nad nią (po obróceniu profilu o 180°).



TWIN8

EDGE10  
BC

MIKRO10

MIKRO-LINE12  
J



## SPECIAL APPLICATION / SPECJALNE

A group of profiles with a broad application spectrum - for the ceiling, wall, architectural, stair, wardrobe. Designed for specialist applications. Among them, the PEN8 with the highest number of holders (i.a.: extension arms, flat, simple and stretcher holders) for creating a number of combinations and achieving the defined illumination effects.

Grupa profili o szerokim spektrum przeznaczenia – ścienne, sufitowe, architektoniczne, schodowe, garderobiane. Zaprojektowane do specjalistycznych zastosowań. Wśród nich PEN8 z największą ilością uchwytów (m.in.: wysięgniki, płaskie, proste, rozporowe) do tworzenia szeregu kombinacji i osiągnięcia określonych efektów świetlnych.



PEN8  
I

BACK10  
A/UX

STEP10  
C

AMBI12  
C

ARC12  
CD/U5

FIX12

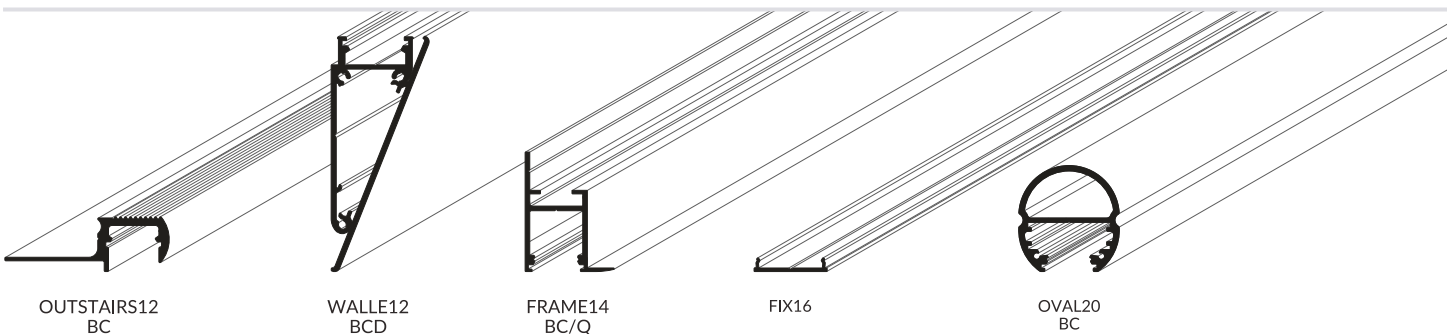

OUTSTAIRS12  
BC

WALLE12  
BCD

FRAME14  
BC/Q

FIX16

OVAL20  
BC

# What does a profile name indicate? / Co oznacza nazwa profilu?

## SURFACE10 BC/UX

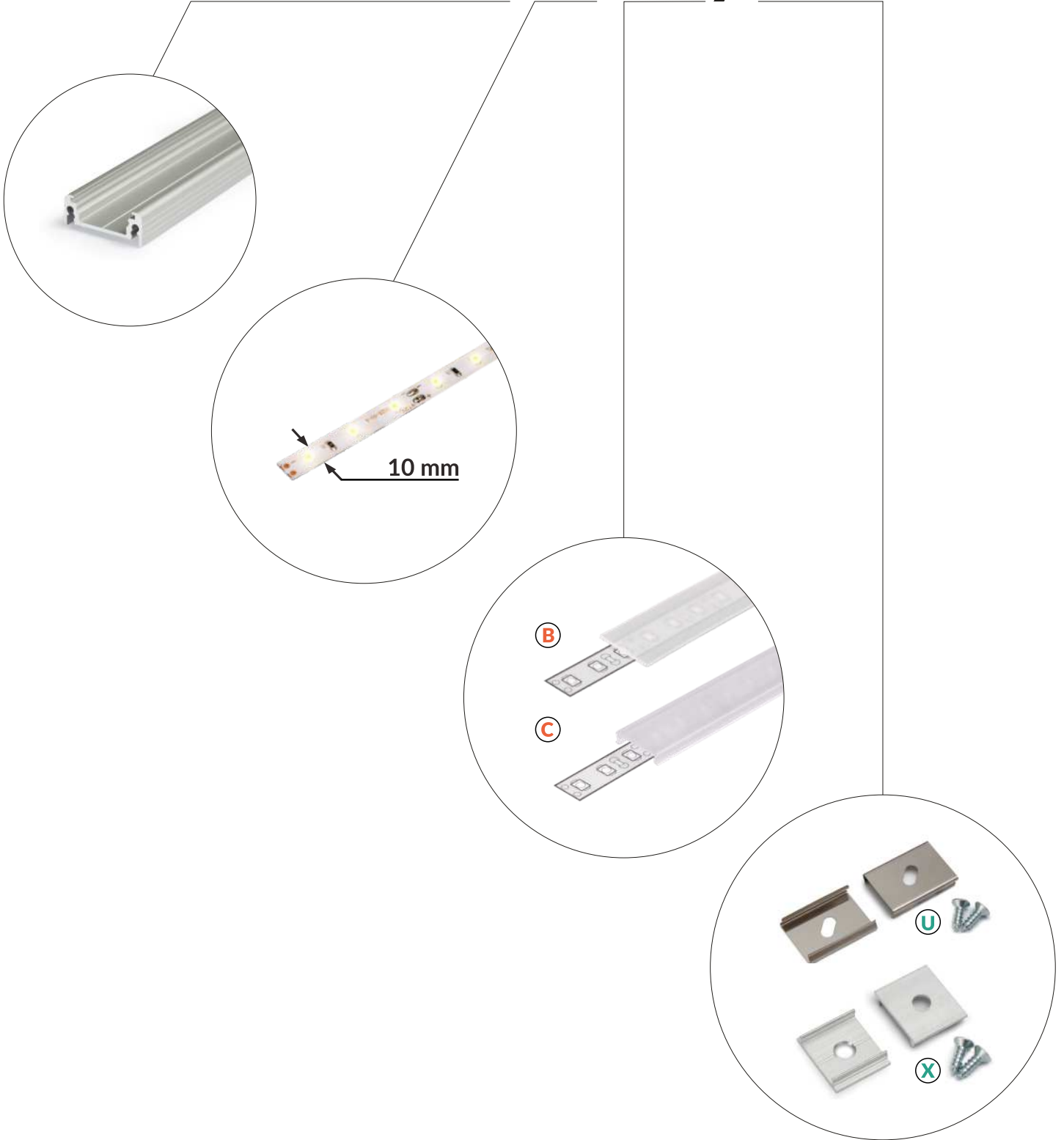

# Slick

We also have profiles with the Slick socket in our assortment. This feature allows to click in or slide in the cover.

W naszym asortymencie posiadamy także profile z gniazdem Slick. Funkcja ta pozwala na łatwe „wklikiwanie” lub wsuwanie klosza.

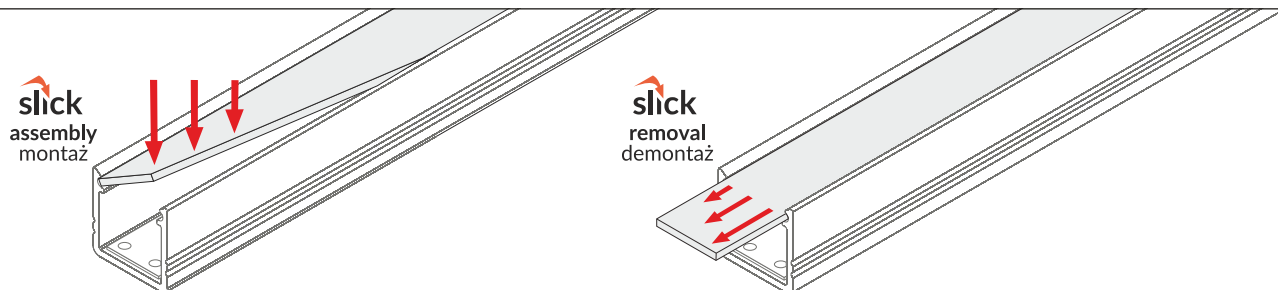

Profiles with Slick socket:

Poniżej profile wyposażone w gniazdo Slick:

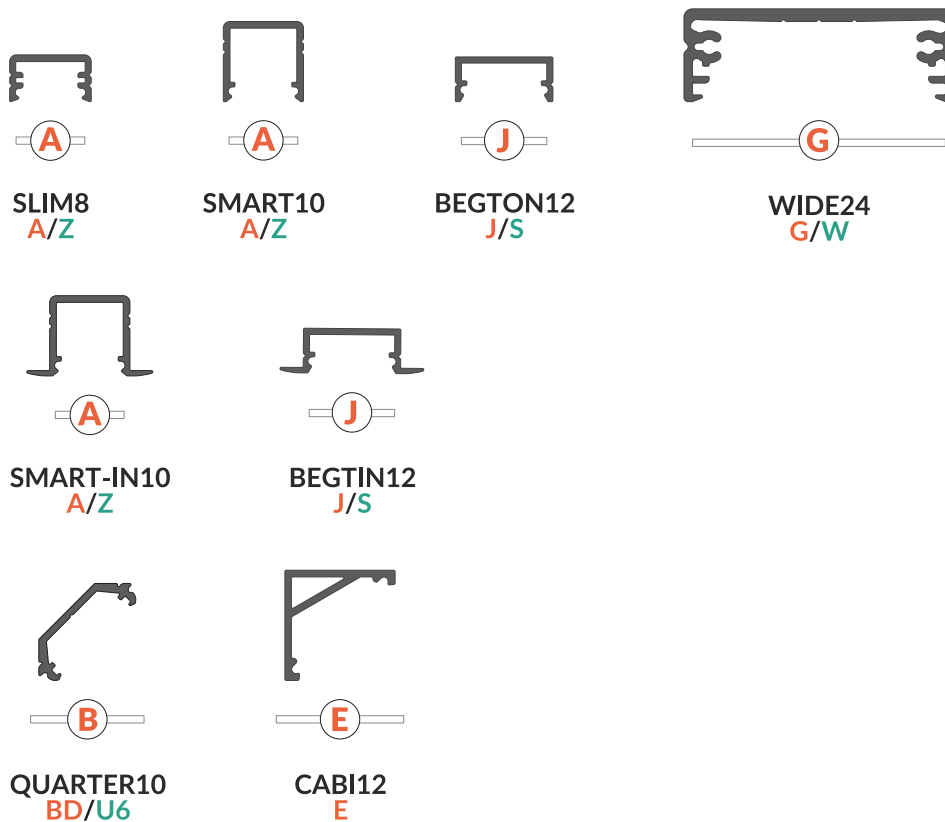

# How to select a cover? / Jak dobrać klosz?

Covers for aluminium LED profiles differ in the degree of transparency. Thanks to a conscious choice, you can plan the lighting effect, light dispersion and distribution better. A transparent cover absorbs a smaller amount of light, followed by frosted and white ones.

Klosze do profili aluminiowych LED różnią się stopniem transparentności. Dzięki świadomemu wyborowi można lepiej zaplanować efekt świetlny, rozproszenie i rozsył światła. Klosz transparentny pochłania najmniejszą ilość światła, dalej szron i mleczny.

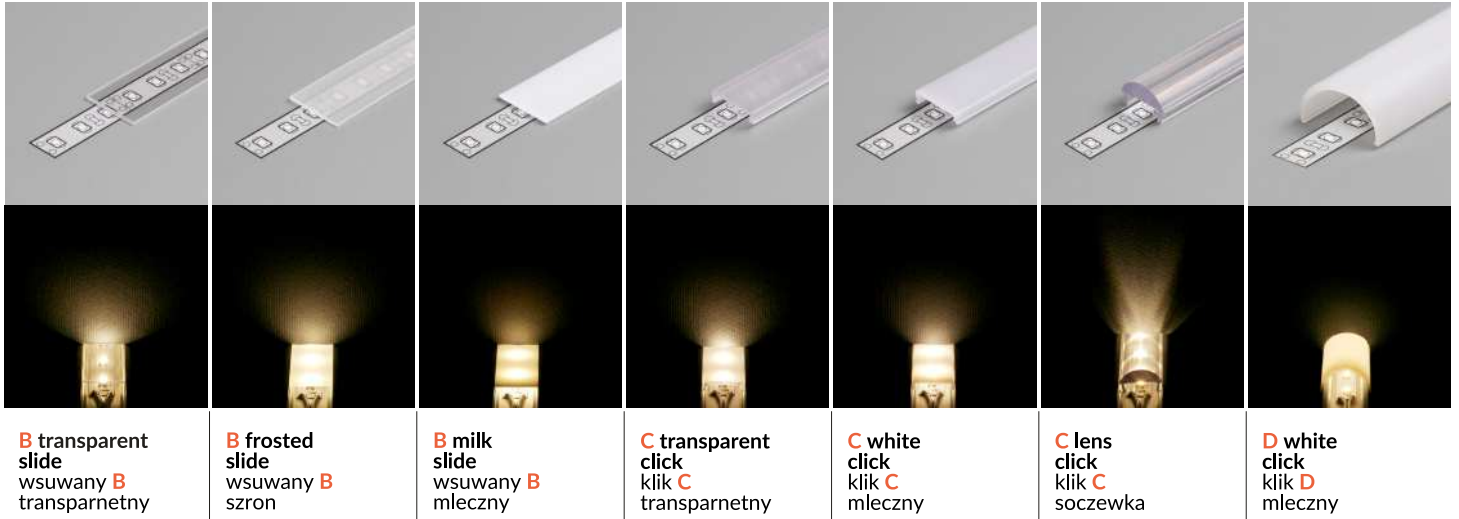

It also means a different degree of visibility of LED points. White covers in some profiles, in conjunction with a 120 P/m tape, allow to achieve the effect of a continuous line of light.

Oznacza to także różny stopień widoczności punktów LED. Klosze mleczne w niektórych profilach w połączeniu z taśmą 120 P/m pozwalają osiągnąć efekt ciągłej linii światła.

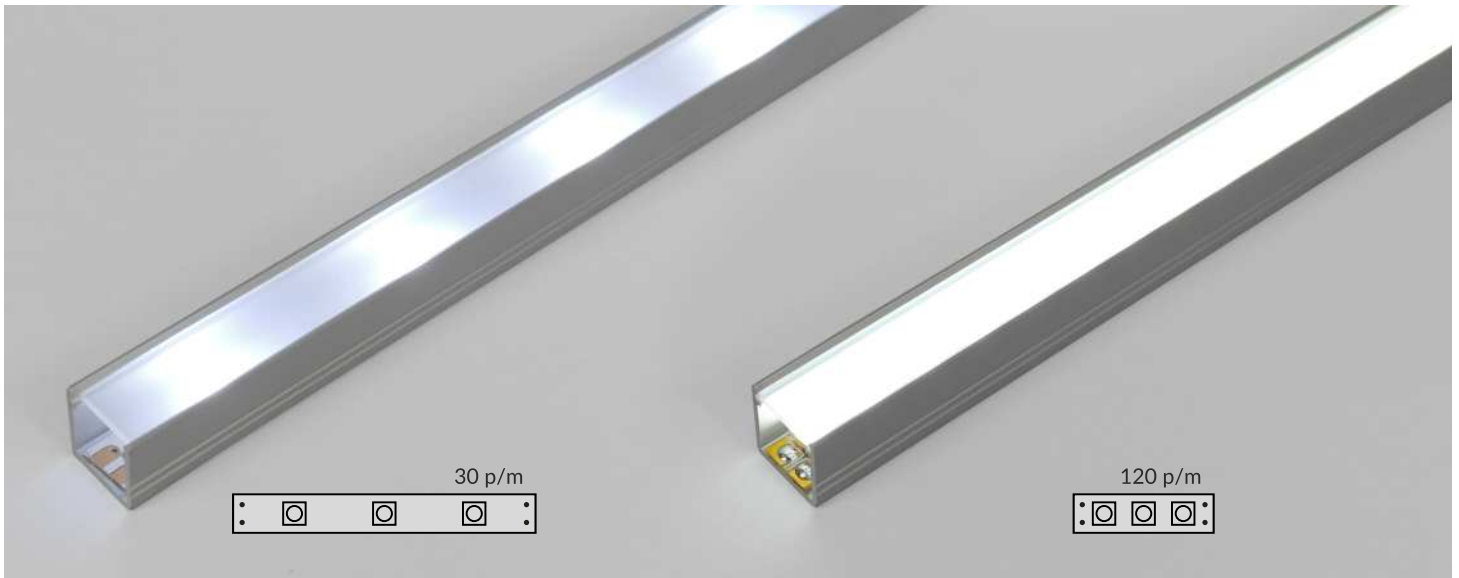

The covers also differ in the method of assembly.

Klosze różnią się także sposobem montażu.

## SLIDE COVER (labelling: A, B, E, G, H, J)

It is a strip of plastic available in 3 different degrees of transparency. It needs to be slid from the beginning of the profile and dragged along the marked socket or clicked in the Slick socket.

## KLOSZ WSUWANY (oznaczenia: A, B, E, G, H, J)

Jest to pasek tworzywa dostępny w 3 różnych stopniach transparentności. Należy go wsunąć od początku profilu i przeciągnąć wzdłuż oznaczonego gniazda lub „wkliknąć” w gniazdo Slick.

## CLICK COVER (labelling: C, D, F, I, K)

Its assembly and removal are more convenient. Access to the ends of the profile is not necessary, which allows to click in the cover even after installing the profile in a recess or a piece of furniture.

## KLOSZ KLIK (oznaczenia: C, D, F, I, K)

Jego montaż i demontaż jest wygodniejszy. Dostęp do końców profilu nie jest konieczny, co pozwala wkliknąć klosz nawet po zamontowaniu profilu we wnęce lub w meblu.

Many of the covers in the TOPMET offer are system accessories. It means that one cover fits a few, different profiles.

A letter describing the socket helps correct matching.

And so, e.g., the SURFACE10 BC/UX profile can be fitted with the covers:

- B slide
- C click
- C lens

Cover C click, on the other hands, fits the profiles:

- SURFACE10 BC/UX
- UNI12 BCD/U
- GROOVE BC/UX
- DEEP10 BC/UX
- TRIO10 BC
- CORNER10 BC/UX
- EDGE10 BC
- STEP10 C
- WALLE12 CD
- AMBI12 C
- ARC12 CD/U5
- OUTSTAIRS12 BC
- FRAME14 BC/Q
- OVAL20 BC

W ofercie TOPMET wiele spośród kloszy to akcesoria systemowe. Oznacza to, że ten sam klosz pasuje do kilku różnych profili.

W odpowiednim dopasowaniu pomaga litera opisująca gniazdo.

I tak np. do profilu LED SURFACE10 BC/UX pasują klosze:

- B wsuwany
- C klik
- C soczewka

Klosz C klik z kolei pasuje do profili:

- SURFACE10 BC/UX
- UNI12 BCD/U
- GROOVE BC/UX
- DEEP10 BC/UX
- TRIO10 BC
- CORNER10 BC/UX
- EDGE10 BC
- STEP10 C
- WALLE12 CD
- AMBI12 C
- ARC12 CD/U5
- OUTSTAIRS12 BC
- FRAME14 BC/Q
- OVAL20 BC

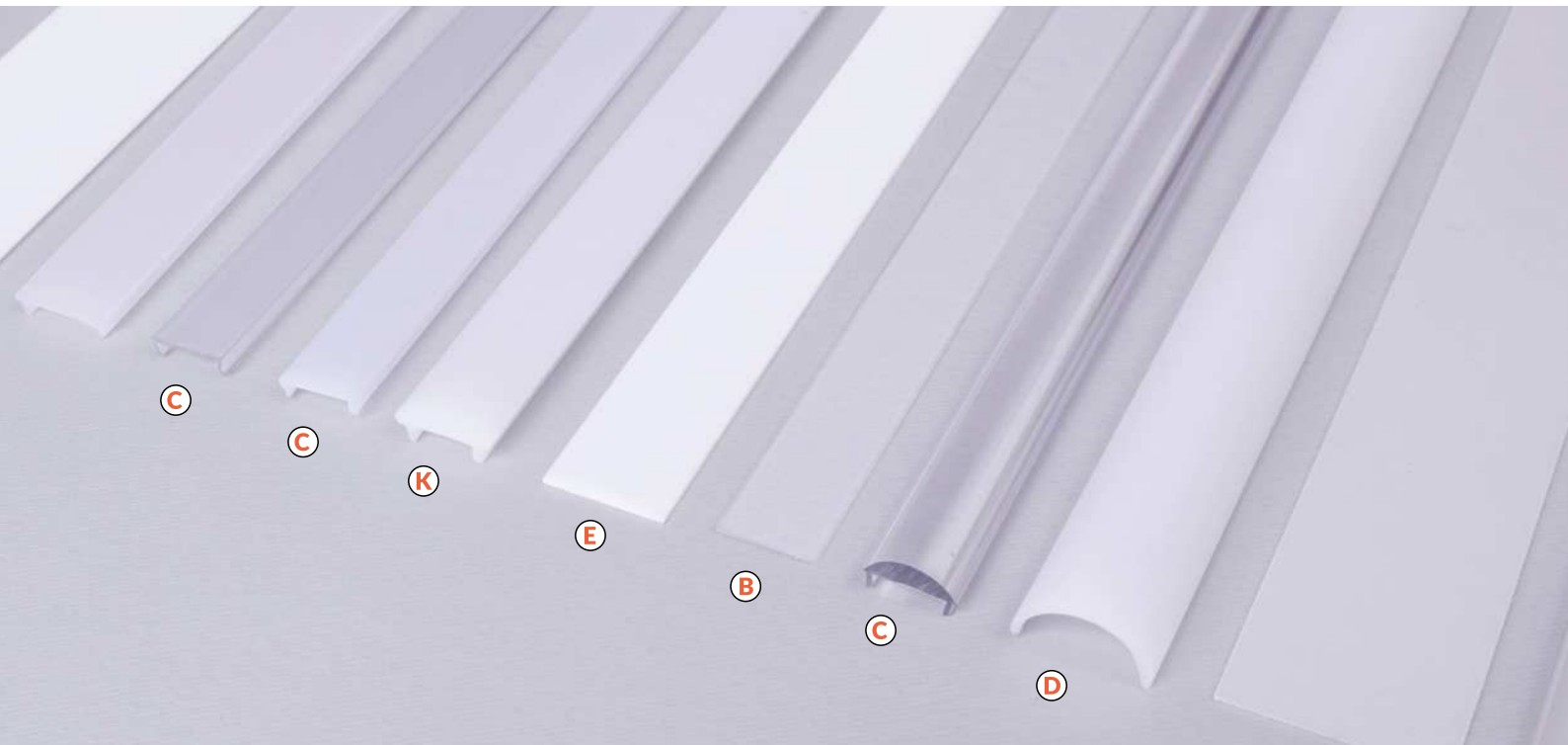

# Covers / Klosze

The covers in the TOPMET offer differ between one another not only in terms of the achieved lighting effect but also in terms of technical parameters. Among the special cover, one stands out in particular - designed for the FLOOR12 LED profile, the K white cover. Its characteristic feature is the high resistance to damage and impacts with a degree of IK 08. This is why it is possible to tread over it - without having to worry about cracking or scratching.

Klosze z oferty TOPMET różnią się między sobą nie tylko uzyskanym efektem świetlnym, ale również parametrami technicznymi. Wśród kloszy specjalnych wyróżnia się zwłaszcza jeden – przeznaczony do profilu LED FLOOR12, czyli klosz K mleczny. Jego cechą charakterystyczną jest wysoka odporność na uszkodzenia oraz uduary o stopniu IK 08. Dzięki temu możliwe jest chodzenie po nim - bez obaw o pęknięcie czy zarysowania.

cover type rodzaj klosza	material materiał	work temperature temperatura stosowania		UV resistance odporność na UV	fire hazard certificate according to IEC 60695-2-11 certyfikat na palność wg PN-EN 60695-2-11	transparency transpa- rentność	coefficient diffusion współczynnik rozproszenia
		min [°C]	max [°C]				
<b>A B E G H</b> transparent transparentny	PC	-50	100	✓	✓	93%	low niski
<b>A B E G H</b> frosted szron	PP	-15	85	✓	✓	90%	low niski
<b>A B E G H</b> white mleczny	PP	-15	85	✓	✓	70%	high wysoki
<b>C</b> transparent transparentny	PMMA	-20	70	✓	✓	93%	low niski
<b>C</b> white mleczny	PMMA	-20	70	✓	✓	75%	low niski
<b>C</b> lens soczewka	PC	-50	100	✓	✓	90%	low niski
<b>D</b> white mleczny	PMMA	-20	70	✓	✓	70%	high wysoki
<b>F</b> transparent transparentny	PMMA	-20	70	✓	✓	93%	low niski
<b>F</b> white mleczny	PMMA	-20	70	✓	✓	75%	medium średni
<b>I</b> frosted szron	PC	-50	100	✓	✓	90%	low niski
<b>I</b> white mleczny	PC	-50	100	✓	✓	80%	medium średni
<b>K</b> white mleczny	PC	-50	100	✓	✓	60%	high wysoki

# Endings / Zaślepki

The endings, with the aim to aesthetically close the profile and additionally protect the LED source, come in four basic colours: silver, white, black and grey. The endings selected for the profiles for glass are available in transparent colour.

The material used for the production of the endings meets the lighting non-combustibility standard no.: PN-EN 60695-2-11. Material: ABS, PC.

Zaślepki, mające na celu estetyczne domknięcie profilu oraz dodatkową ochronę źródła LED, występują w czterech podstawowych kolorach: srebrnym, białym, czarnym i szarym. Wybrane zaślepki do profili do szyb dostępne są w kolorze transparentnym.

Tworzywo użyte do produkcji zaślepek spełnia oświetleniową normę niepalności nr: PN-EN 60695-2-11. Materiał: ABS, PC.



**Endings with a hole or without it - which one to choose? Many of our endings come in two versions:**

Zaślepki z otworem czy bez - jakie wybrać? Wiele spośród naszych zaślepek występuje w dwóch wersjach:



**With a hole:** they allow aesthetic outlet for a cable without the need to drill through the ending or the profile.

Z otworem: pozwalają na estetyczne wyprowadzenie przewodu bez konieczności przewiercania zaślepki lub profilu.



**Without a hole:** they are an aesthetic and a tighter ending of the profile. Recommended in cases where the appearance is particularly significant, or from the opposite side to the cable outlet.

Bez otworu: stanowią estetyczne i szczelniejsze zakończenie profilu. Zalecane tam, gdzie szczególnie istotny jest wygląd lub od strony przeciwnej niż wyprowadzenie przewodu.

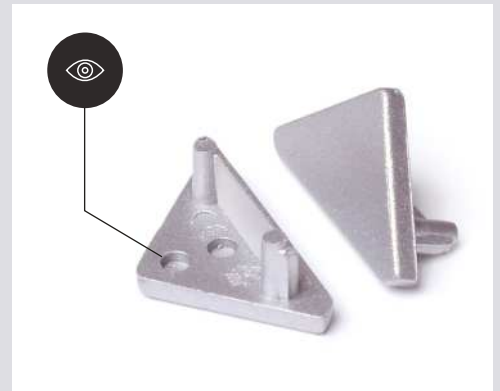

**For new products, we offer endings with points to bore a hole. Thanks to this, from one set of endings, it is possible to obtain one ending of each type: with a hole and without one. They are available for the profiles: ARC12, BEGTON12, CABI12, LINEA20, QUARTER10, TRIO10.**

Do nowych produktów oferujemy zaślepki z punktami do nawiercenia otworu. Dzięki temu z jednego kompletu zaślepek możliwe jest otrzymanie po jednej zaślepce: z otworem oraz bez otworu. Są one dostępne dla profili: ARC12, BEGTON12, CABI12, LINEA20, QUARTER10, TRIO10.

# Mounting accessories / Akcesoria montażowe

SYSTEM ACCESSORIES – fit many different profiles.

DEDICATED ACCESSORIES - matched to one profile, are usually used for a more precise assembly method: pendant, on an extension arm, at an angle, etc.

AKCESORIA SYSTEMOWE – pasują do wielu różnych profili.

AKCESORIA DEDYKOWANE - dopasowane do jednego profilu, zwykle służą do bardziej sprecyzowanego rodzaju montażu: podwieszanego, na wysięgniku, pod kątem itp.

## MOUNTING PLATES, HOLDERS / UCHWYTY

flexible / sprężyste



**U flexible mounting plate**  
uchwyt U sprężysty



**cone U flexible mounting plate**  
uchwyt U sprężysty cone



**rack U flexible mounting plate**  
uchwyt U sprężysty rack

aluminium / aluminiowe



**X mounting plate**  
uchwyt X



**T mounting plate**  
uchwyt T

simple - for perpendicular assembly in a furniture board (cabinets)

proste - do montażu prostokątnego w płycie meblowej (szafki)



**SLIM8 simple holder**  
uchwyt SLIM8 prosty



**SURFACE10 simple holder**  
uchwyt SURFACE10 prosty



**WIDE24 simple holder**  
uchwyt WIDE24 prosty



**PEN8 simple holder**  
uchwyt PEN8 prosty



**OVAL20 simple holder**  
uchwyt OVAL20 prosty

„cone” or „slot”?  
„cone” czy „fasolka”?

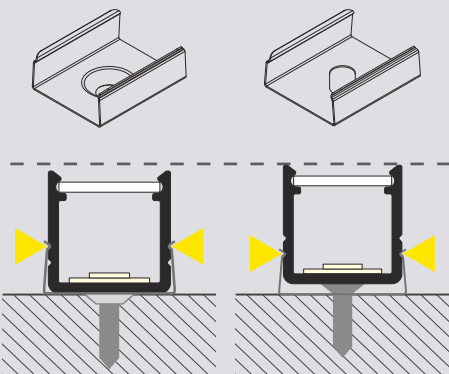



## EXTENSION ARMS / WYSIĘGNIKI



**OVAL20 double extension arm**  
wysięgnik OVAL20 podwójny



**PEN8 double holder with thread**  
uchwyt PEN8 podwójny z gwintem



**PEN8 jointed holder with soffit ceiling**  
uchwyt PEN8 przegubowy z podsufitką

## CONNECTORS / ŁĄCZNIKI

Easy method of joining 2 profile sections in a straight line or at a defined angle.  
Łatwy sposób na łączenie 2 odcinków profili w linii prostej lub pod określonym kątem.



**X connector**  
łącznik X



**SURFACE10 L connector**  
łącznik L SURFACE10



**T connector**  
łącznik T



**GROOVE10 L connector**  
łącznik L GROOVE10



**CORNER10 L connector**  
łącznik L CORNER10



**LINEA20 connectors / łączniki LINEA20:**

60°

90°

120°

135°

180°

**LINEA20 bent connectors / łączniki LINEA20 gięte:**

90°

270°

## SLINGS / ZAWIESIA

They enable creating pendant luminaires. They are especially recommended for the LED LINEA 20 profile (see pages 2.27-2.28) but are also compatible with most of the profiles.

Umożliwiają tworzenie opraw wiszących. Szczególnie polecane są do profilu LED LINEA20 (patrz str. 2.27-2.28), ale kompatybilne są także z większością profili.

50 V



**SELV sling 50V 1500**  
zawiesie SELV 50V 1500



**sling for LED mounting 1500**  
zawiesie do uchwytu LED 1500



# LED accessories / Akcesoria LED

Different LED sources and electronic components can be used for aluminium LED profiles. The correct sequence of connecting individual elements is very important.

Do aluminiowych profili LED można stosować różne źródła LED oraz elektroniczne komponenty. Bardzo istotna jest właściwa kolejność połączenia poszczególnych elementów.

## Source / Źródło



We have LED strips with different power, luminous flux and width to choose from. We also have strips available with different light colour temperatures - a few different temperatures of white and primary colours, as well as RGB and warm-cold with adjustable light colour temperature). The most commonly used sources are the ones for the 12 V voltage but sources for the 24 V voltage are also available. Apart from the most popular LED strips available on the market, there are also LED modules on a rigid surface. They are usually characterized by better light parameters and quality. Waterproof sources and components are a special part of the offer.

Depending on the LED selection, you need to match the remaining accessories: cables, connectors, switches, controllers and power supplies.

Some LED sources available on the market may exceed radiation capabilities of a given aluminium profile. In order to ensure correct operation, a LED source with appropriate parameters needs to be matched to an aluminium profile.

## LED cable • connectors • distribution box Przewód LED • złączki • konektor



In the case of connecting a few sources to one power supply, you can use a connector for mini-connector with 6 sockets or a LED divider. Our offer also includes cables of different lengths for one colour of LED strips, as well as special ones for RGB strips and separately, for waterproof strips.

## Switch • controller / Włącznik • sterownik



A lighting fixture set can be enriched with different types of convenient solutions regarding switching, dimming and change of colour. Mechanical switches are available - integrated with the cable or for connecting directly to the LED source, under the cover inside the profile. Turning on is possible both by touch, as well as radio waves - with a remote control via a controller. You can control the colour (with an appropriate light source selected) as well as illuminance.

## 12 V or 24 V power supply Zasilacz 12 V lub 24 V

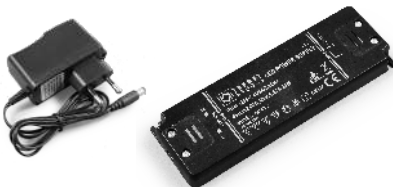

12 V

or / lub

24 V

The selection of the power supply requires calculation of the power to be consumed by the source, according to the indications of the manufacturer. From the primary side, the current has a voltage of 220-240 V, on the secondary side, to which the LED is connected, the voltage is 12 V or 24 V.

## 220-240 V cable / Przewód 220-240 V



220  
-240V

220 - 240 V cables, which allow the connection of an entire set to the power supply are also in our offer. A standard cable is 4 m long and a cable with a foot switch - 3.5 m.

More details are available in the LED accessories catalogue (pages: 9.2-9.13).

Do wyboru mamy taśmy LED'owe o różnej mocy, strumieniu świetlnym i szerokości. Dostępne są również taśmy o różnej temperaturze barwowej światła – kilka różnych temperatur bieli oraz podstawowe kolory, a także RGB oraz ciepła-zimna z możliwością zmiany temperatury barwowej światła). Najpowszechniej stosowane są źródła dostosowane do napięcia 12 V, ale dostępne są również źródła na 24 V. Poza dostępnymi na rynku najpopularniejszymi taśmami LED istnieją również moduły LED'owe na sztywnym podłożu. Zazwyczaj charakteryzują się znacznie lepszymi parametrami i jakością światła. Specjalną częścią oferty są źródła i komponenty wodoodporne.

Według wybranego źródła LED należy dobierać pozostałe akcesoria: przewody, złączki, włączniki, sterowniki oraz zasilacze.

Niektóre źródła LED dostępne na rynku mogą przekraczać radiacyjne możliwości wybranego profilu aluminiowego. W celu zapewnienia poprawnego działania, należy dobrać do profilu aluminiowego źródło LED o odpowiednich parametrach.

W przypadku podłączenia kilku źródeł do jednego zasilacza, można użyć konektora do mini-złączek z 6 gniazdami lub rozdzielacza LED. Nasza oferta obejmuje także przewody o różnej długości, do jednego koloru taśm LED, a także specjalne do taśm RGB i osobno do taśm wodoodpornych.

Zestaw oświetleniowy można wzbogacić o różnego rodzaju wygodne rozwiązania włączania, ściemniania oraz zmiany koloru. Dostępne są włączniki mechaniczne – zintegrowane z przewodem lub do podłączenia bezpośrednio do źródła LED pod kłosem wewnątrz profilu. Włączanie możliwe jest zarówno przez dotyk, jak i przez fale radiowe – pilotem za pośrednictwem sterownika. Sterować można zarówno barwę (przy wyborze odpowiedniego źródła) oraz natężenie światła.

Dobór zasilacza wymaga przeliczenia mocy, jaką będzie pobierać źródło według wskazań producenta. Od strony pierwotnej prąd ma napięcie 220-240 V, po stronie wtórnej, do której podłączamy LED, napięcie wynosi 12 V lub 24 V.

W naszej ofercie są także przewody 220 – 240 V pozwalające podłączyć cały zestaw do zasilania. Standardowy przewód ma długość 4 m, przewód z włącznikiem nożnym – 3,5 m.

Więcej szczegółów dostępnych jest w katalogu akcesoriów LED (str.: 9.2-9.13).







**SURFACE**  
**NAWIERZCHNIOWE**

**2017**

**LED profiles**  
**profile LED**

## SMALL, ALUMINIUM, SURFACE PROFILE

### MAŁY, ALUMINIOWY PROFIL NAWIERZCHNIOWY

- decorative lighting profile
- universal application
- Slick socket
- 2 channels for mounting bracket (with or without wall distance)
- painted holders
- maximum LED strip width: 8 mm
- profil dekoracyjno-oświetleniowy
- uniwersalne zastosowanie
- gniazdo Slick
- 2 rowki - 2 poziomy przymocowania uchwyty (z dystansem od ściany lub bez)
- malowane uchwyty
- maksymalna szerokość taśmy LED: 8 mm

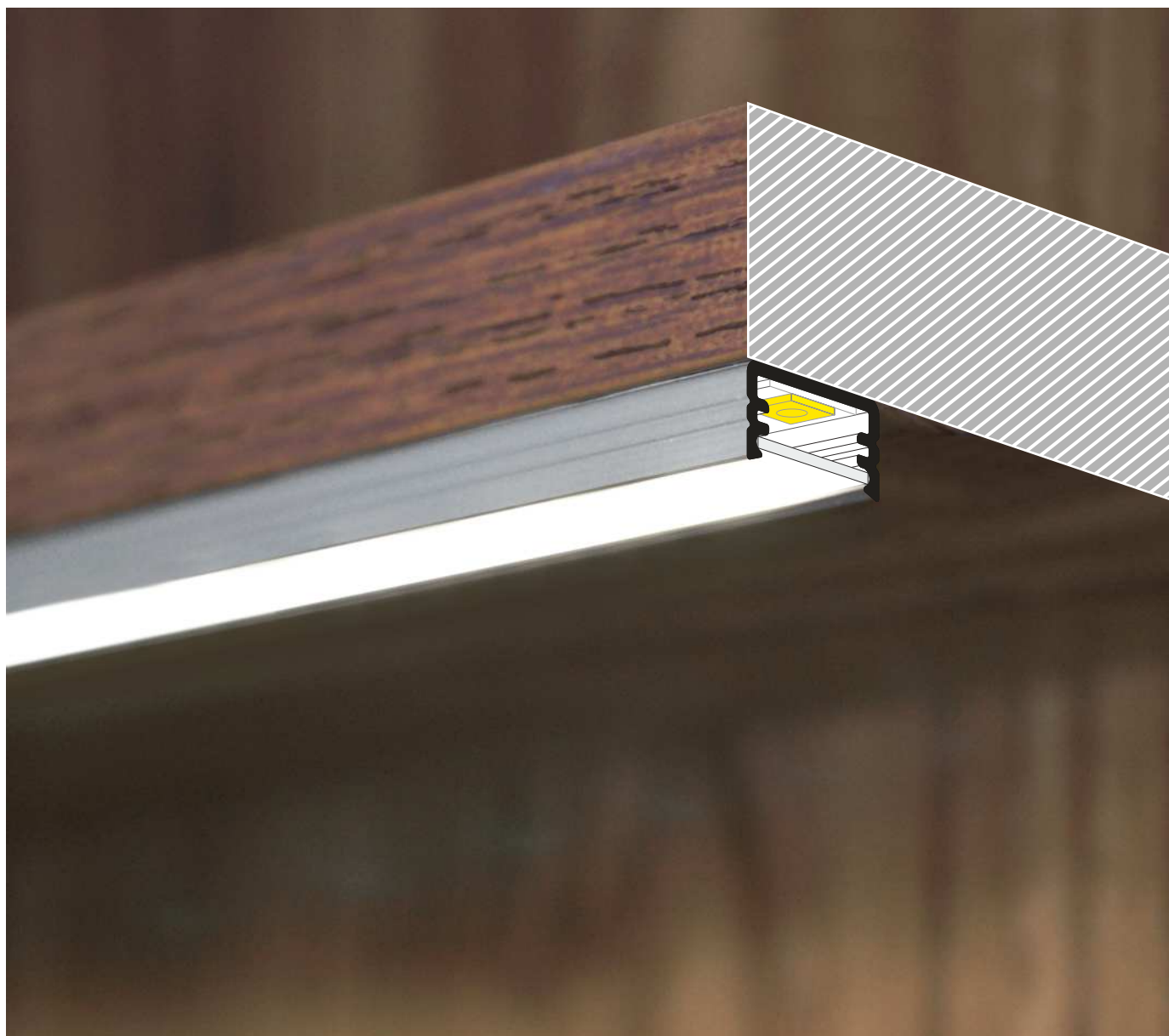

## SIMILAR IN THE OFFER / PODOBNE W OFERCIE





**A** slide cover  
klosz A wsuwany

**Z**<sup>1</sup> Z flexible mounting plate  
uchwyt Z sprężysty

**Z**<sup>2</sup> cone Z flexible mounting plate  
uchwyt Z sprężysty cone

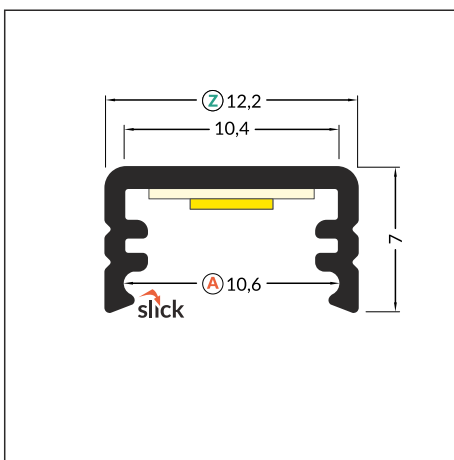
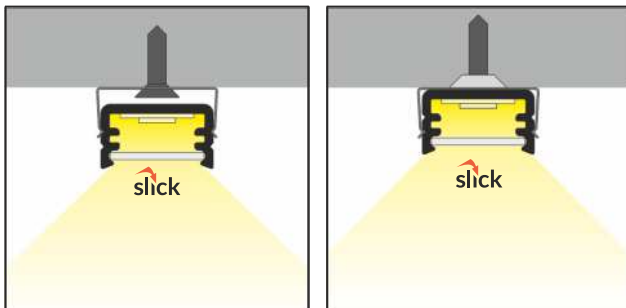
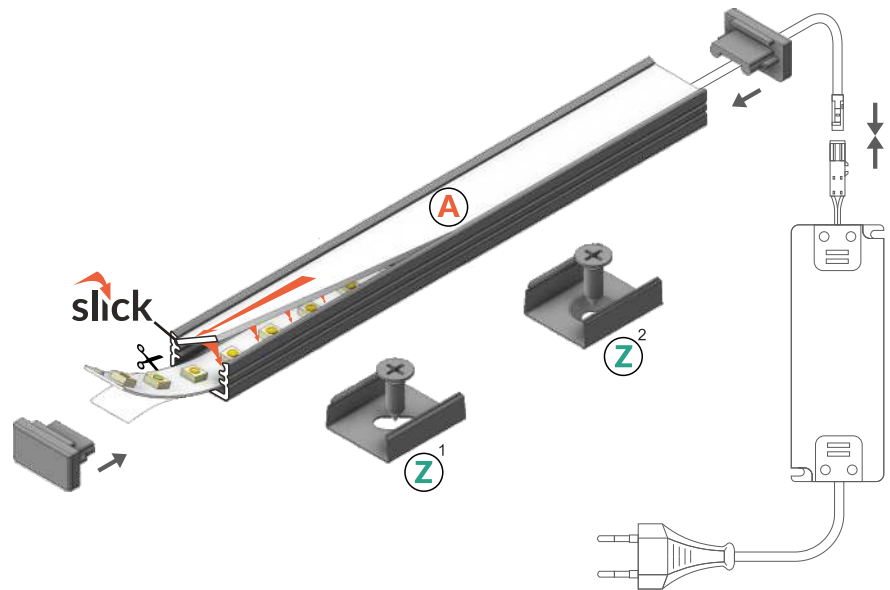

max 8 mm

surface  
nawierzchniowy



INDEX = 1 pc, length 2000 mm  
package = 10 pcs  
INDEKS = 1 szt., długość 2000 mm  
opakowanie = 10 szt.

white painted  
biały malowany  
89030001

anodized  
anodowany  
89030020

black anodized  
czarny anodowany  
89030021

raw aluminium  
surowe aluminium  
89030000

Available lengths / Dostępne długości  
1000 mm, 2000 mm, 3000 mm, 4000 mm



## COVERS / KLOSZE

**A slide cover**  
colours: transparent, frosted, white  
material: PC, PP, PP

klosz **A** wsuwany  
kolory: transparentny, szron, mleczny  
materiał: PC, PP, PP

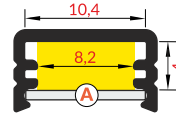
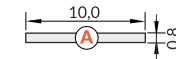

**Note!** Dimensions of the space  
to install LED source  
**Uwaga!** Wymiary przestrzeni  
do zamontowania źródła LED

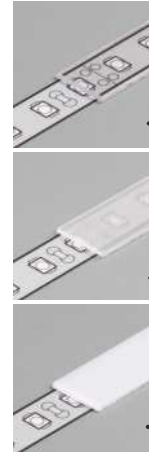

INDEX = 1 pc, length 2000 mm  
package = 10 pcs  
INDEKS = 1 szt., długość 2000 mm  
opakowanie = 10 szt.

**A transparent / A transparentny**  
89070016

**A frosted / A szron**  
89070039

**A white / A mleczny**  
89070038

## ENDINGS / ZAŚLEPKI

**SLIM8 ending**  
colours: white, silver, black, grey  
material: ABS

zaślepka SLIM8  
kolory: biały, srebrny, czarny, szary  
materiał: ABS

**SLIM8 ending with hole**  
colours: white, silver, black, grey  
material: ABS

zaślepka SLIM8 z otworem  
kolory: biały, srebrny, czarny, szary  
materiał: ABS

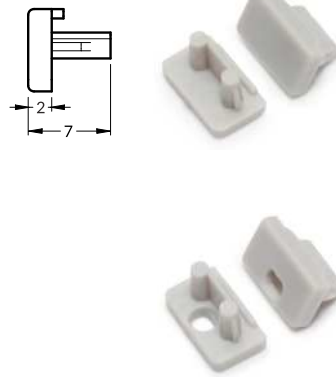
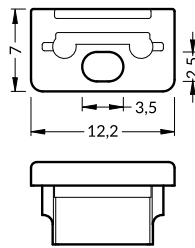

INDEX = 1 set  
package of 10 sets = 20 pcs  
INDEKS = 1 komplet, opakowanie  
zawiera 10 kompletów = 20 szt.

**white / biały**  
with hole z otworem 89960001 | without hole bez otworu 89040001

**silver / srebrne**  
with hole z otworem 89960040 | without hole bez otworu 89040040

**black / czarne**  
with hole z otworem 89960002 | without hole bez otworu 89040002

**grey / szare**  
with hole z otworem 89960022 | without hole bez otworu 89040022

## MOUNTINGS / MOCOWANIA

**Z flexible mounting plate**  
colours: white, inox, black  
material: stainless steel

uchwyt **Z** sprężysty  
kolory: biały, inox, czarny  
materiał: stal nierdzewna

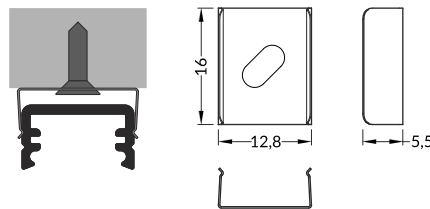

INDEX = 1 set  
package of 10 sets = 20 pcs  
INDEKS = 1 komplet  
opakowanie zawiera 10 kpl = 20 szt

**Z flexible mounting plate**  
uchwyt **Z** sprężysty

**white biały** 89270001

**inox inox** 89270019

**black czarny** 89270002

**cone Z flexible mounting plate**  
colours: white, inox, black  
material: stainless steel

uchwyt **Z** sprężysty cone  
kolory: biały, inox, czarny  
materiał: stal nierdzewna

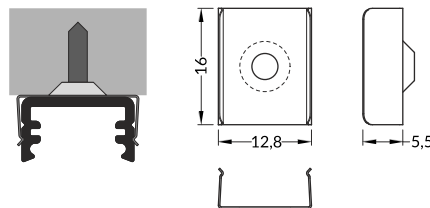

**cone Z flexible mounting plate**  
uchwyt **Z** sprężysty cone

**white biały** 89980001

**inox inox** 89980019

**black czarny** 89980002

**SLIM8 simple holder**  
material: zinc coated steel

uchwyt SLIM8 prosty  
materiał: stal ocynkowana

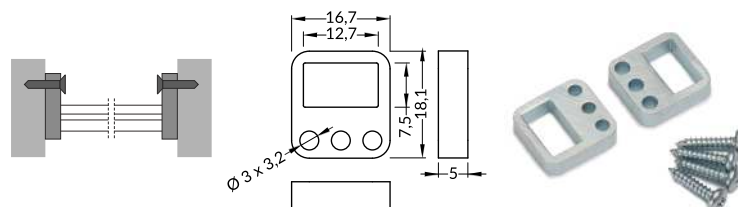

INDEX = 1 set = 2 pcs  
INDEKS = 1 komplet = 2 szt.

**simple holder**  
uchwyt prosty

**zinc coated**  
stal ocynkowana  
89110030







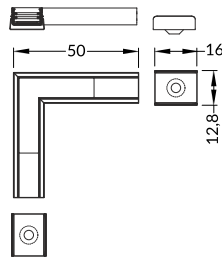

## CONNECTORS / ŁĄCZNIKI

**SLIM8 L connector**  
colours: white, anodized, black  
material: aluminium

łącznik L SLIM8  
kolory: biały, anodowany, czarny  
materiał: aluminium



INDEX = 1 set  
INDEKS = 1 komplet

-  white painted  
biały malowany  
89150001
-  anodized  
anodowany  
89150020
-  black anodized  
czarny anodowany  
89150021



## CONTINUOUS LINE OF LIGHT IN A SMALL OVERALL DIMENSIONS

### CIĄGŁA LINIA ŚWIATŁA W MAŁYM GABARYCIE

- decorative and lighting profile
- continuous line of light (when using LED strip 120 P/m and white cover)
- SLICK socket
- miniature dimensions
- universal application
- the possibility of using waterproof LED strips
- maximum width of LED strip: 10 mm

- profil dekoracyjno-oświetleniowy
- ciągła linia światła (przy zastosowaniu taśmy 120 P/m i klosza mlecznego)
- gniazdo SLICK
- miniaturowe gabaryty
- uniwersalne zastosowanie
- możliwość zastosowania taśm wodoodpornych
- maksymalna szerokość taśmy LED: 10 mm



## SIMILAR IN THE OFFER / PODOBNE W OFERCIE



SLIM8  
A/Z



SMART-IN10  
A/Z



SURFACE10  
BC/UX



BEGTON12  
J/S



SURFACE14  
EF/TY



**A** slide cover  
klosz A wsuwany

**Z**<sup>1</sup> Z flexible mounting plate  
uchwyt Z sprężysty

**Z**<sup>2</sup> cone Z flexible mounting plate  
uchwyt Z sprężysty cone

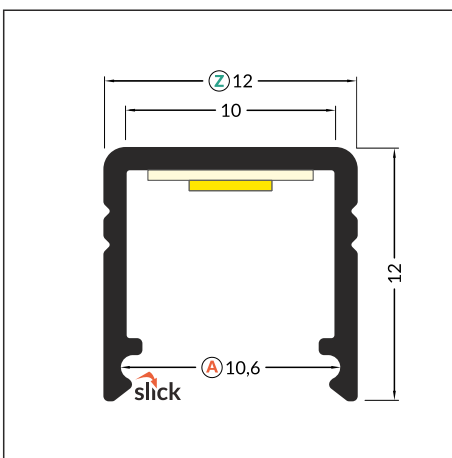
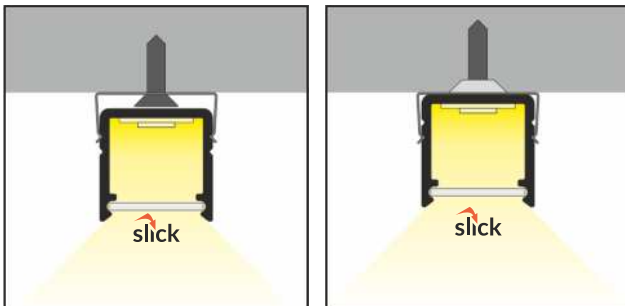
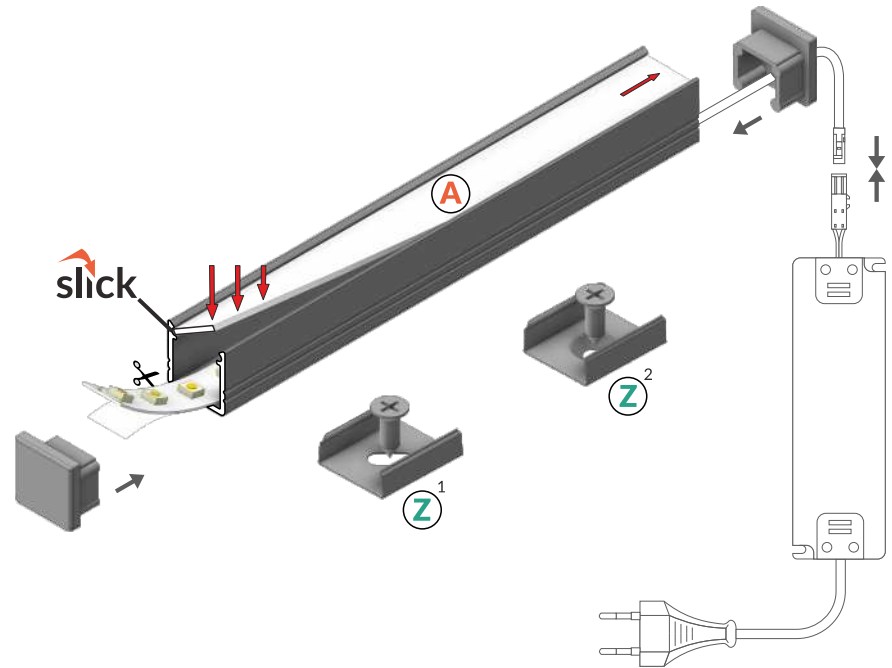

 max 10 mm

 surface  
nawierzchniowy



INDEX = 1 pc, length 2000 mm  
package = 10 pcs  
INDEKS = 1 szt., długość 2000 mm  
opakowanie = 10 szt.

 white painted  
biały malowany  
C2020001

 anodized  
anodowany  
C2020020

 black anodized  
czarny anodowany  
C2020021

 raw aluminium  
surowe aluminium  
C2020000



Available lengths / Dostępne długości  
1000 mm, 2000 mm, 3000 mm, 4000 mm



## COVERS / KLOSZE

**A slide cover**  
colours: transparent, frosted, white  
material: PC, PP, PP

klosz **A** wsuwany  
kolory: transparentny, szron, mleczny  
materiał: PC, PP, PP



**Note!** Dimensions of the space to install LED source  
**Uwaga!** Wymiary przestrzeni do zamontowania źródła LED

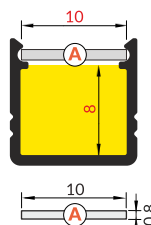

INDEX = 1 pc, length 2000 mm  
package = 10 pcs  
INDEKS = 1 szt., długość 2000 mm  
opakowanie = 10 szt.

**A transparent / A transparentny**  
89070016

**A frosted / A szron**  
89070039

**A white / A mleczny**  
89070038

## ENDINGS / ZAŚLEPKI

**SMART10 ending**  
colours: white, silver, black, grey  
material: ABS

zaślepka SMART10  
kolory: biały, srebrny, czarny, szary  
materiał: ABS

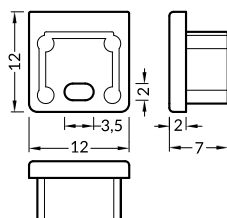

**SMART10 ending with hole**  
colours: white, silver, black, grey  
material: ABS

zaślepka SMART10 z otworem  
kolory: biały, srebrny, czarny, szary  
materiał: ABS

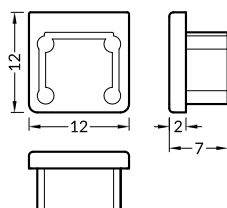

INDEX = 1 set  
package of 10 sets = 20 pcs  
INDEKS = 1 komplet, opakowanie  
zawiera 10 kompletów = 20 szt.

**white / białe**  
without hole bez otworu | with hole z otworem  
C2940001 | C2960001

**silver / srebrne**  
without hole bez otworu | with hole z otworem  
C2940040 | C2960040

**black / czarne**  
without hole bez otworu | with hole z otworem  
C2940002 | C2960002

**grey / szare**  
without hole bez otworu | with hole z otworem  
C2940022 | C2960022

## MOUNTINGS / MOCOWANIA

**Z flexible mounting plate**  
colours: white, inox, black  
material: stainless steel

uchwyt **Z** sprężysty  
kolory: biały, inox, czarny  
materiał: stal nierdzewna

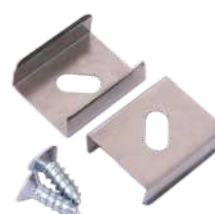
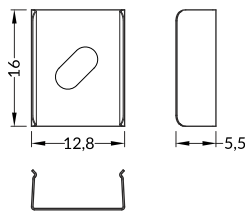
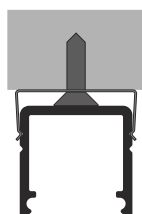

INDEX = 1 set  
package of 10 sets = 20 pcs  
INDEKS = 1 komplet  
opakowanie zawiera 10 kpl = 20 szt.

**Z flexible mounting plate**  
uchwyt **Z** sprężysty

**white biały** 89270001

**inox inox** 89270019

**black czarny** 89270002

**cone Z flexible mounting plate**  
colours: white, inox, black  
material: stainless steel

uchwyt **Z** sprężysty cone  
kolory: biały, inox, czarny  
materiał: stal nierdzewna

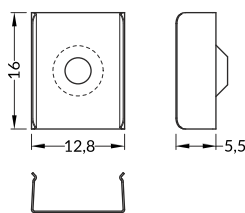
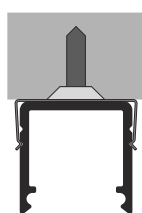

**cone Z flexible mounting plate**  
uchwyt **Z** sprężysty cone

**white biały** 89980001

**inox inox** 89980019

**black czarny** 89980002





## CONNECTORS / ŁĄCZNIKI

**SMART10 connector 90 deg**  
colours: white, anodized, black  
material: aluminium

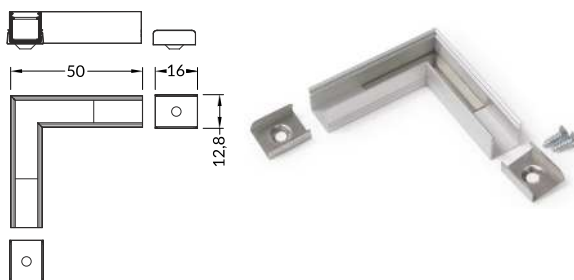
łącznik SMART10 90 st  
kolory: biały, anodowany, czarny  
materiał: aluminium



INDEX = 1 set  
INDEKS = 1 komplet

-  white painted  
biały malowany  
**C2910001**
-  anodized  
anodowany  
**C2910020**
-  black anodized  
czarny anodowany  
**C2910021**



# SURFACE10 BC/UX

## ALUMINIUM SURFACE PROFILE

### ALUMINIOWY PROFIL NAWIERZCHNIOWY

- hidden mounting
- decorative and lighting profile
- wide range of accessories, 6 types of covers
- maximum LED strip width: 10 mm
- ukryte mocowanie
- profil dekoracyjno oświetleniowy
- szeroki wybór akcesoriów, 6 rodzajów kloszy
- maksymalna szerokość taśmy LED: 10 mm

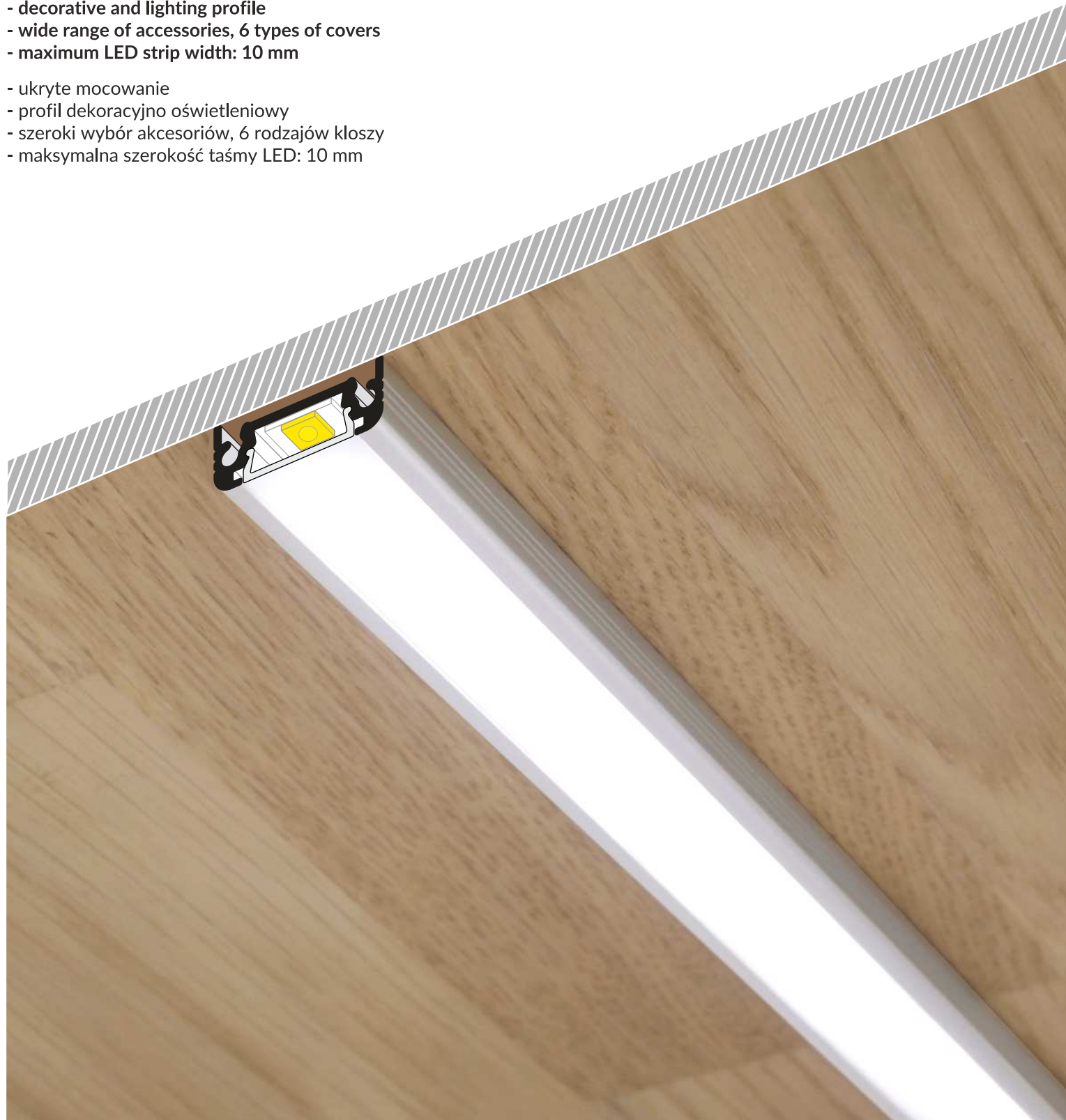

## SIMILAR IN THE OFFER / PODOBNE W OFERCIE



SLIM8  
A/Z



SMART10  
A/Z



BEGTON12  
J/S



SURFACE14  
EF/TY



LINEA20  
EF/TY



WIDE24  
G/W



**B** slide cover  
klosz B wsuwany

**C** click cover  
klosz C klik

**C** lens cover  
klosz C soczewka

**U**<sup>1</sup> flexible mounting plate  
uchwyt U sprężysty

**U**<sup>2</sup> cone U flexible mounting plate  
uchwyt U sprężysty cone

**X**<sup>1</sup> mounting plate  
uchwyt X

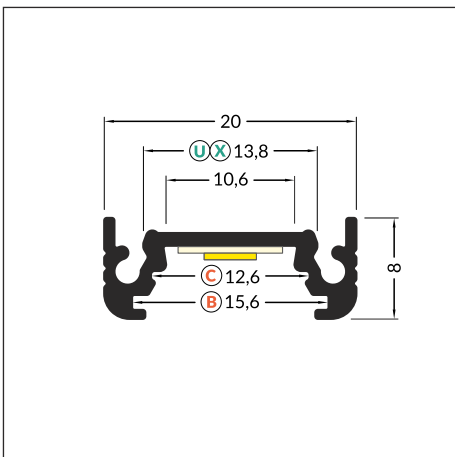
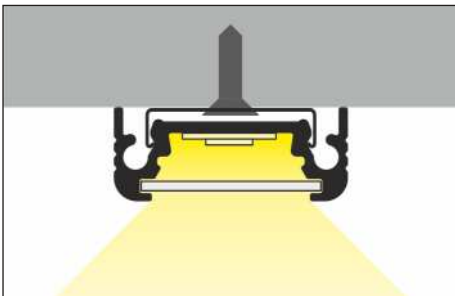
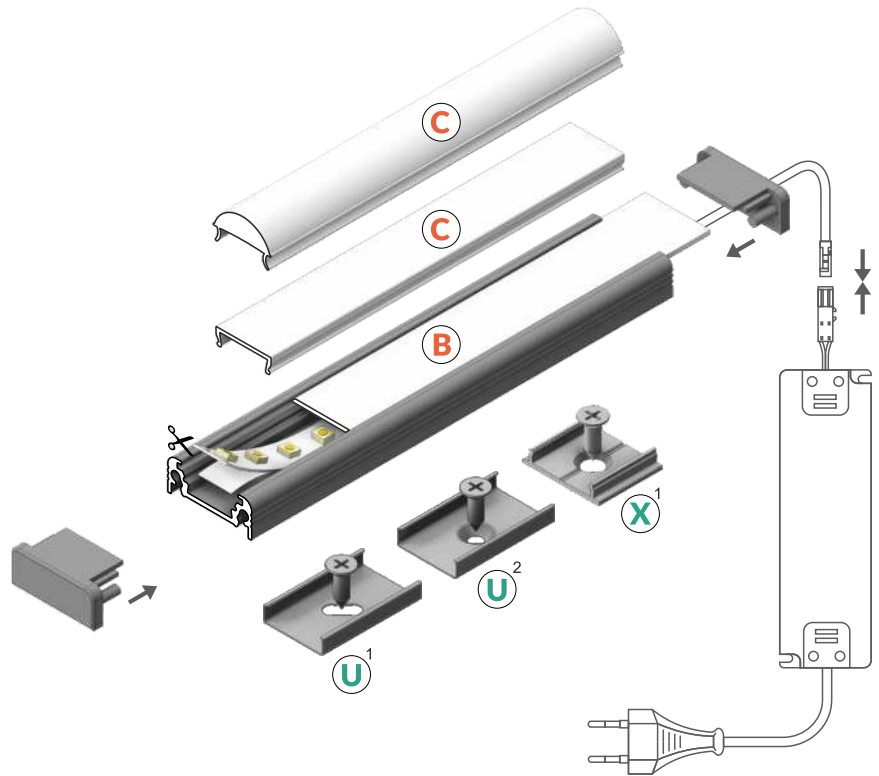

 max 10 mm

 surface  
nawierzchniowy



INDEX = 1 pc, length 2000 mm  
package = 10 pcs  
INDEKS = 1 szt., długość 2000 mm  
opakowanie = 10 szt.

 white painted  
biały malowany  
77270001



 anodized  
anodowany  
77270020



 black anodized  
czarny anodowany  
77270021



 raw aluminium  
surowe aluminium  
77270000

Available lengths / Dostępne długości  
1000 mm, 2000 mm, 3000 mm, 4000 mm



## COVERS / KLOSZE

**B slide cover**  
colours: transparent, frosted, white  
material: PC, PP, PP

klosz **B** wsuwany  
kolory: transparentny, szron, mleczny  
materiał: PC, PP, PP

**C click cover**  
colours: transparent, white  
material: PMMA

klosz **C** klik  
kolory: transparentny, mleczny  
materiał: PMMA

**C click cover lens**  
colour: transparent  
material: PC

klosz **C** klik soczewka  
kolor: transparentny  
materiał: PC



**Note!** Dimensions of the space to install LED source  
**Uwaga!** Wymiary przestrzeni do zamontowania źródła LED

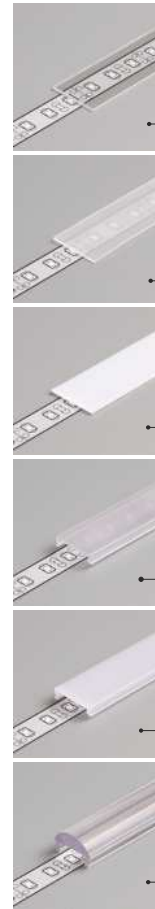
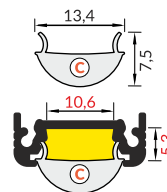
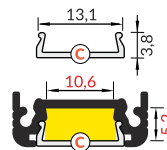
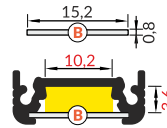

INDEX = 1 pc, length 2000 mm  
package = 10 pcs  
INDEKS = 1 szt., długość 2000 mm  
opakowanie = 10 szt.

**B transparent / B transparentny**  
76250016

**B frosted / B szron**  
76250039

**B white / B mleczny**  
76250038

**C transparent / C transparentny**  
76330000

**C white / C mleczny**  
76330038

**C lens / C soczewka**  
76300000

## MOUNTINGS / MOCOWANIA

**U flexible mounting plate**  
colours: inox  
material: stainless steel

uchwyt **U** sprężysty  
kolory: inox  
materiał: stal nierdzewna

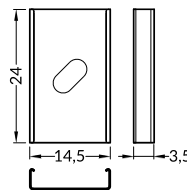
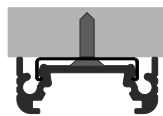

INDEX = 1 set  
package of 10 sets = 20 pcs  
INDEKS = 1 komplet  
opakowanie zawiera 10 kpl = 20 szt

**U flexible mounting plate**  
uchwyt **U** sprężysty

inox 76380000

**cone U flexible mounting plate**  
colours: inox  
material: stainless steel

uchwyt **U** sprężysty cone  
kolory: inox  
materiał: stal nierdzewna

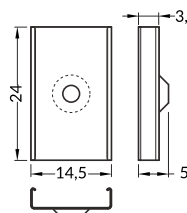
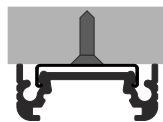

**cone U flexible mounting plate**  
uchwyt **U** sprężysty cone

inox 76620000

**X mounting plate**  
colours: raw aluminium  
material: aluminium

uchwyt **X**  
kolory: surowe aluminium  
materiał: aluminium

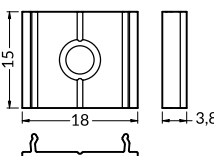
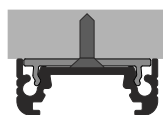

**X mounting plate**  
uchwyt **X**

raw aluminium  
surowe aluminium  
76260000

**SURFACE10 simple holder**  
material: zinc coated

uchwyt SURFACE10 prosty  
materiał: stal ocynkowana

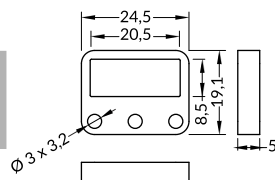
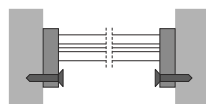

INDEX = 1 set = 2 pcs  
INDEKS = 1 komplet = 2 szt.

**simple holder**  
uchwyt prosty

zinc coated  
stal ocynkowana  
77370030





## ENDINGS / ZAŚLEPKI

**endings SURFACE10**  
colours: white, silver, black, grey  
material: ABS  
zaślepka SURFACE10 bez otworu  
kolory: biały, srebro, czarny, szary  
materiał: ABS

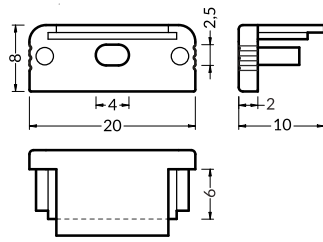

**endings SURFACE10 with hole**  
colours: white, silver, black, grey  
material: ABS  
zaślepka SURFACE10 z otworem  
kolory: biały, srebro, czarny, szary  
materiał: ABS

INDEX = 1 set  
package of 10 sets = 20 pcs  
INDEKS = 1 komplet, opakowanie  
zawiera 10 kompletów = 20 szt.

 white białe	with hole z otworem 77520001	without hole bez otworu 77280001
 silver srebro	with hole z otworem 77520040	without hole bez otworu 77280040
 black czarne	with hole z otworem 77520002	without hole bez otworu 77280002
 grey szare	with hole z otworem 77520022	without hole bez otworu 77280022

## CONNECTORS / ŁĄCZNIKI

**X connector**  
colour: inox  
material: aluminium  
łącznik X sprężysty  
kolor: inox  
materiał: aluminium

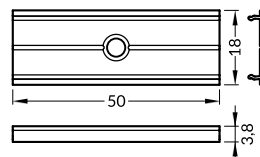

**SURFACE10 L connector**  
colours: white, anodized, black  
material: aluminium  
łącznik L SURFACE10  
kolory: biały, anodowany, czarny  
materiał: aluminium

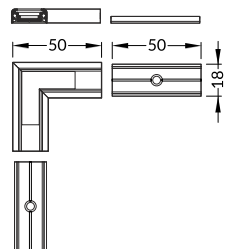

INDEX = 1 set  
INDEKS = 1 komplet

**X connector**  
łącznik X

 raw aluminium surowe aluminium 76350000
--

**L connector**  
łącznik L

 white painted biały malowany 77410001
 anodized anodowany 77410020
 black anodized czarny anodowany 77410021



# BEGTON12 J/S



## SMALL SURFACE ALUMINIUM PROFILE

### MAŁY ALUMINIOWY PROFIL NAWIERZCHNIOWY

- decorative and lighting profile
- light weight, budget profile
- Slick socket
- maximum LED strip width: 12 mm
- profil dekoracyjno-oświetleniowy
- lekki profil budżetowy
- gniazdo z funkcją Slick
- maksymalna szerokość taśmy LED: 12 mm



## SIMILAR IN THE OFFER / PODOBNE W OFERCIE



SLIM8  
A/Z



SMART10  
A/Z



SURFACE10  
BC/UX



BEGTIN12  
J/S



SURFACE14  
EF/TY



- J** slide cover  
klosz J wsuwany
- S<sup>1</sup>** flexible mounting plate  
uchwyt S sprężysty
- S<sup>2</sup>** cone S flexible mounting plate  
uchwyt S sprężysty cone

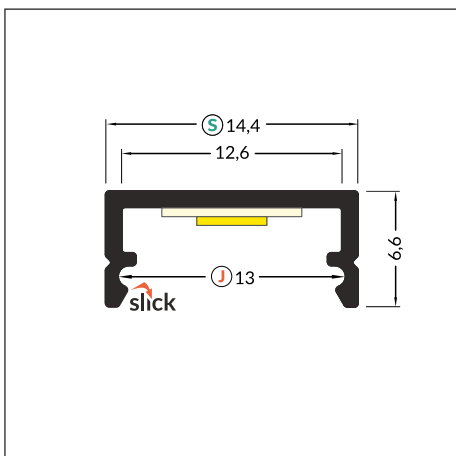
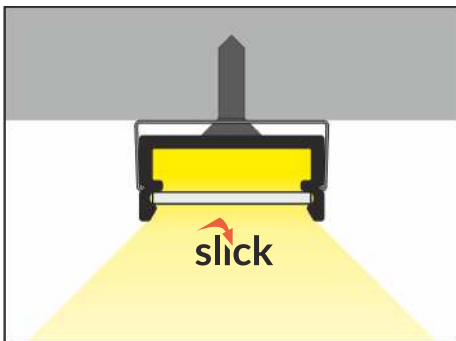
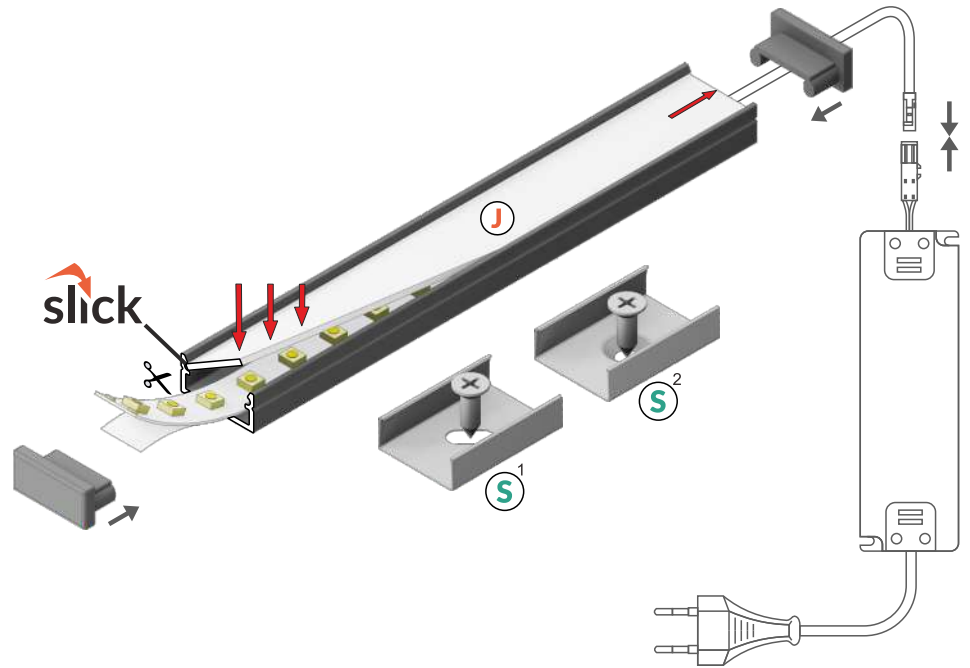

white painted  
biały malowany  
C7020001



anodized  
anodowany  
C7020020



black anodized  
czarny anodowany  
C7020021



raw aluminium  
surowe aluminium  
C7020000

 max 12 mm

 surface  
nawierzchniowy

Available lengths / Dostępne długości  
1000 mm, 2000 mm, 3000 mm, 4000 mm



## COVERS / KLOSZE

### J slide cover

colours: transparent, frosted, white  
material: PC, PP, PP

klosz J wsuwany  
kolory: transparentny, szron, mleczny  
materiał: PC, PP, PP



**Note!** Dimensions of the space to install LED source  
**Uwaga!** Wymiary przestrzeni do zamontowania źródła LED

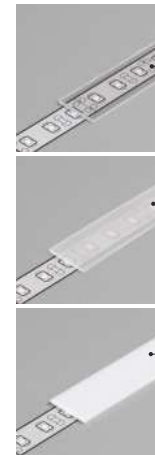
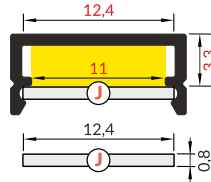

INDEX = 1 pc, length 2000 mm  
package = 10 pcs  
INDEKS = 1 szt., długość 2000 mm  
opakowanie = 10 szt.

J transparent / J transparentny  
70330016

J frosted / J szron  
70330039

J white / J mleczny  
70330038

## ENDINGS / ZAŚLEPKI

### BEGTON12 ending

colours: white, silver, black, grey  
material: ABS

zaślepka BEGTON12  
kolory: biały, srebrny, czarny, szary  
materiał: ABS

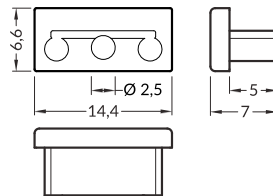

Ending with marked space to bore the holes.  
Zaślepka z punktami do przewiercenia otworów.

INDEX = 1 set  
package of 10 sets = 20 pcs  
INDEKS = 1 komplet, opakowanie  
zawiera 10 kompletów = 20 szt.

white  
białe C7960001

silver  
srebrne C7960040

black  
czarne C7960002

grey  
szare C7960022

## MOUNTINGS / MOCOWANIA

### S flexible mounting plate

colours: white, inox, black  
material: stainless steel

uchwyt S sprężysty  
kolory: biały, inox, czarny  
materiał: stal nierdzewna

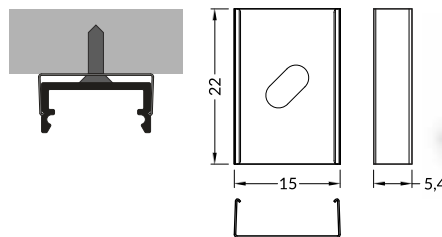

INDEX = 1 set  
package of 10 sets = 20 pcs  
INDEKS = 1 komplet, opakowanie  
zawiera 10 kompletów = 20 szt.

white  
biały C7980001

inox  
inox C7980019

black  
czarny C7980002

### cone S flexible mounting plate

colours: white, inox, black  
material: stainless steel

uchwyt S sprężysty cone  
kolory: biały, inox, czarny  
materiał: stal nierdzewna

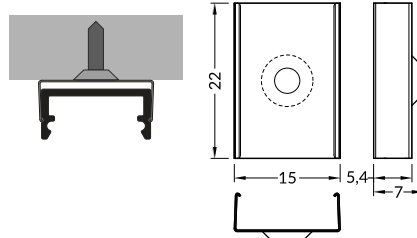

white  
biały C7950001

inox  
inox C7950019

black  
czarny C7950002



# UNI12 BCD/U

## SURFACE AND RECESSED PROFILE

### PROFIL WPUSTOWO-NAWIERZCHNIOWY

- decorative and lighting profile
- 7 diffusers to choose from
- increased radiation - it is possible to use a stronger LED strip
- maximum LED strip width: 12 mm
- profil oświetleniowo-dekoracyjny
- 7 kloszy do wyboru
- zwiększona radiacja - możliwość zastosowania mocniejszej taśmy LED
- maksymalna szerokość taśmy LED: 12 mm



## SIMILAR IN THE OFFER / PODOBNE W OFERCIE



DEEP10  
BC/UX



GROOVE10  
BC/UX



SURFACE10  
BC/UX



BEGTON12  
J/S



FLOOR12  
K/U



GROOVE14  
EF/TY



SURFACE14  
EF/TY



**B** slide cover  
klosz B wsuwany

**C** click cover  
klosz C klik

**C** lens cover  
klosz C soczewka

**D** click cover  
klosz D klik

**U**<sup>1</sup> flexible mounting plate  
uchwyt U sprężysty

**U**<sup>2</sup> cone U flexible mounting plate  
uchwyt U sprężysty cone

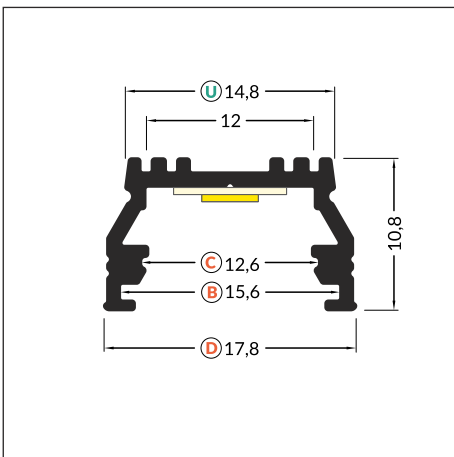
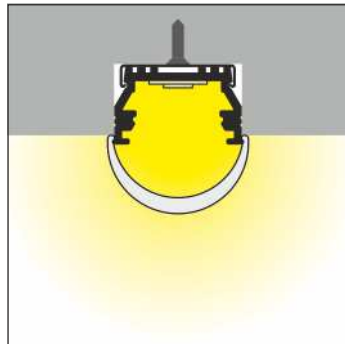
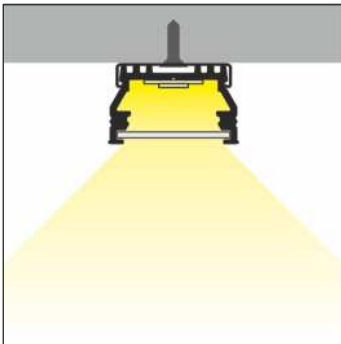
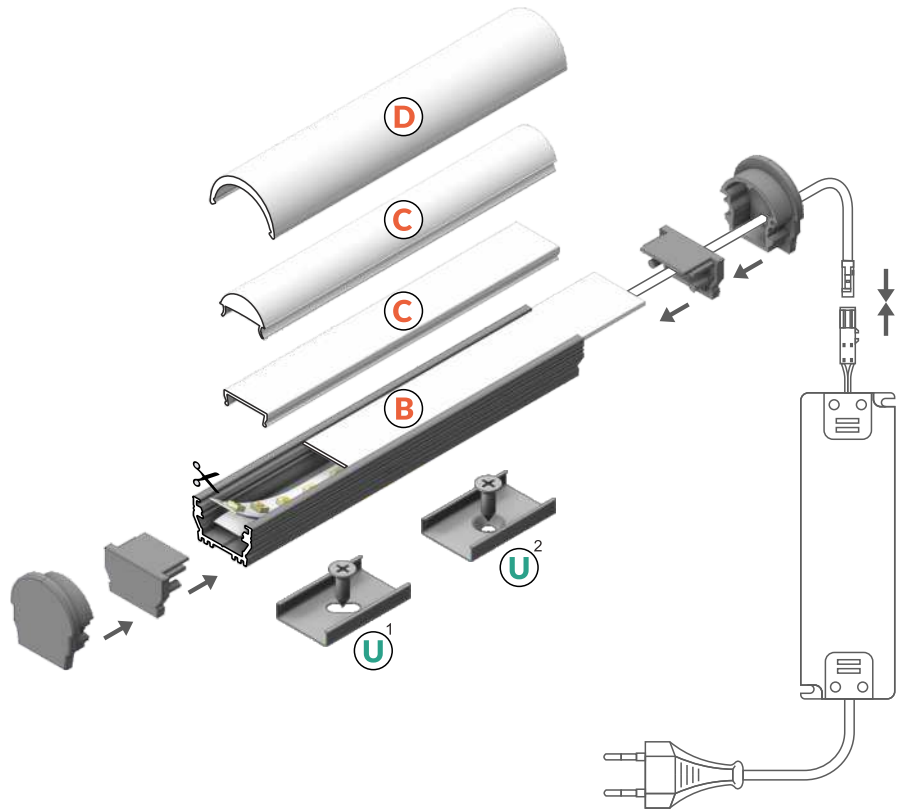

white painted  
biały malowany  
A1020001



anodized  
anodowany  
A1020020



black anodized  
czarny anodowany  
A1020021



raw aluminium  
surowe aluminium  
A1020000

INDEX = 1 pc, length 2000 mm  
package = 10 pcs  
INDEKS = 1 szt., długość 2000 mm  
opakowanie = 10 szt.

Available lengths / Dostępne długości  
1000 mm, 2000 mm, 3000 mm, 4000 mm



## COVERS / KLOSZE



**Note!** Dimensions of the space to install LED source  
**Uwaga!** Wymiary przestrzeni do zamontowania źródła LED

### B slide cover

colours: transparent, frosted, white  
material: PC, PP, PP

klosz B wsuwany  
kolory: transparentny, szron, mleczny  
materiał: PC, PP, PP

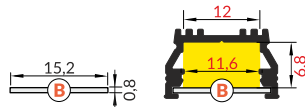

### C click cover

colours: transparent, white  
material: PMMA

klosz C klik  
kolory: transparentny, mleczny  
materiał: PMMA

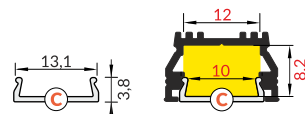

### C lens click cover

colour: transparent  
material: PC

klosz C klik soczewka  
kolor: transparentny  
materiał: PC

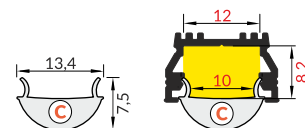

### D click cover

colour: white  
material: PMMA

klosz D klik  
kolor: mleczny  
materiał: PMMA

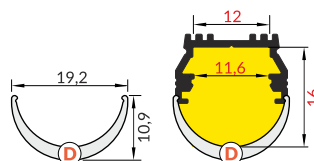

INDEX = 1 pc, length 2000 mm  
package = 10 pcs  
INDEKS = 1 szt., długość 2000 mm  
opakowanie = 10 szt.

B transparent / B transparentny  
76250016

B frosted / B szron  
76250039

B white / B mleczny  
76250038

C transparent / C transparentny  
76330000

C white / C mleczny  
76330038

C lens / C soczewka  
76300000

D white / D mleczny  
A1140038

## MOUNTINGS / MOCOWANIA

### U flexible mounting plate

colour: inox  
material: stainless steel

uchwyt U sprężysty  
kolor: inox  
materiał: stal nierdzewna

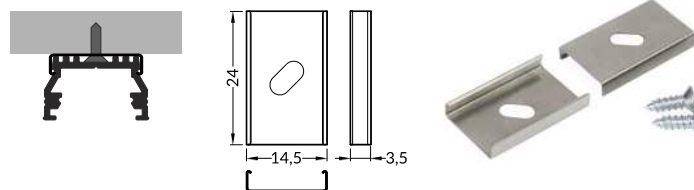

### cone U flexible mounting plate

colour: inox  
material: stainless steel

uchwyt U sprężysty cone  
kolor: inox  
materiał: stal nierdzewna

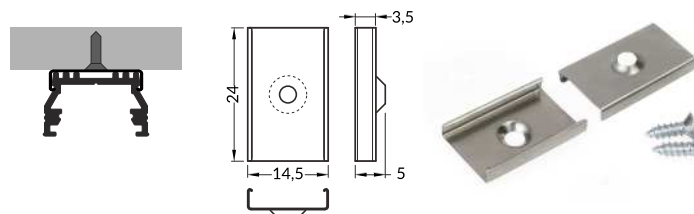

INDEX = 1 set  
package of 10 sets = 20 pcs  
INDEKS = 1 komplet  
opakowanie zawiera 10 kpl = 20 szt

U flexible mounting plate  
uchwyt U sprężysty

inox  
inox 76380000

cone U flexible mounting plate  
uchwyt U sprężysty cone

inox  
inox 76620000

## CONNECTORS / ŁĄCZNIKI

### UNI12 connector 90 deg

colours: white, anodized, black  
material: aluminium

łącznik UNI12 90 st  
kolory: biały, anodowany, czarny  
materiał: aluminium

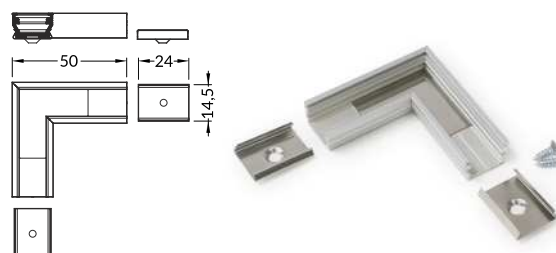

INDEX = 1 set  
INDEKS = 1 komplet

white painted  
biały malowany  
A1910001

anodized  
anodowany  
A1910020

black anodized  
czarny anodowany  
A1910021





## ENDINGS / ZAŚLEPKI

### UNI12 ending

colours: white, silver, black, grey  
material: ABS

zaślepka UNI12

kolory: biały, srebrny, czarny, szary  
materiał: ABS

### UNI12 ending with hole

colours: white, silver, black, grey  
material: ABS

zaślepka UNI12 z otworem

kolory: szary, czarny, biały, srebrny  
materiał: ABS

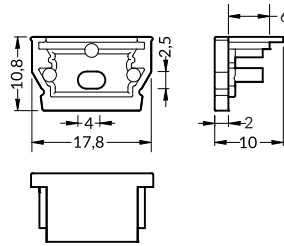

### UNI12 D ending

colours: white, silver, black, grey  
material: ABS

zaślepka UNI12 D

kolory: biały, srebrny, czarny, szary  
materiał: ABS

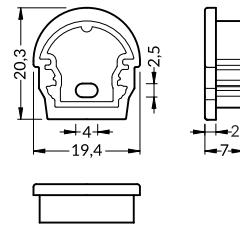

### UNI12 D ending with hole

colours: white, silver, black, grey  
material: ABS

zaślepka UNI12 D z otworem

kolory: szary, czarny, biały, srebrny  
materiał: ABS

INDEX = 1 set  
package of 10 sets = 20 pcs  
INDEKS = 1 komplet, opakowanie  
zawiera 10 kompletów = 20 szt.

	white / białe	
	with hole z otworem	without hole bez otworu
	A1090001	A1070001
	silver / srebrne	
	with hole z otworem	without hole bez otworu
	A1090040	A1070040
	black / czarne	
	with hole z otworem	without hole bez otworu
	A1090002	A1070002
	grey / szare	
	with hole z otworem	without hole bez otworu
	A1090022	A1070022

	white / białe	
	with hole z otworem	without hole bez otworu
	A1960001	A1940001
	silver / srebrne	
	with hole z otworem	without hole bez otworu
	A1960040	A1940040
	black / czarne	
	with hole z otworem	without hole bez otworu
	A1960002	A1940002
	grey / szare	
	with hole z otworem	without hole bez otworu
	A1960022	A1940022



# SURFACE14 EF/TY

## ALUMINIUM SURFACE PROFILE

### ALUMINIOWY PROFIL NAWIERZCHNIOWY

- decorative and lighting profile
- hidden mounting
- maximum LED strip width: 14 mm
- profil dekoracyjno-oświetleniowy
- ukryte mocowanie
- maksymalna szerokość taśmy LED: 14 mm



## SIMILAR IN THE OFFER / PODOBNE W OFERCIE

SLIM8  
A/Z

SMART10  
A/Z

SURFACE10  
BC/UX

LINEA20  
EF/TY

WIDE24  
G/W



**E** slide cover  
klosz E wsuwany

**F** click cover  
klosz F klik

**E7** click cover  
klosz E7 klik

**Y**<sup>1</sup> flexible mounting plate  
uchwyt Y sprężysty

**Y**<sup>2</sup> cone Y flexible mounting plate  
uchwyt Y sprężysty cone

**T** mounting plate  
uchwyt T

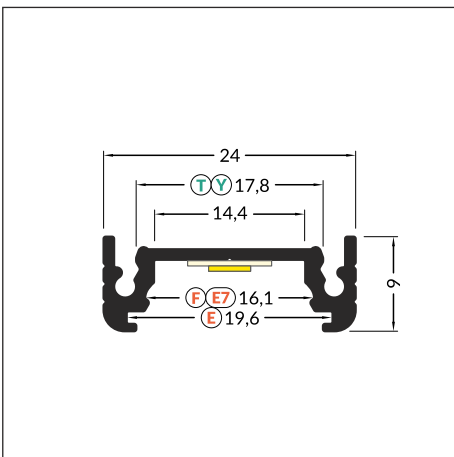
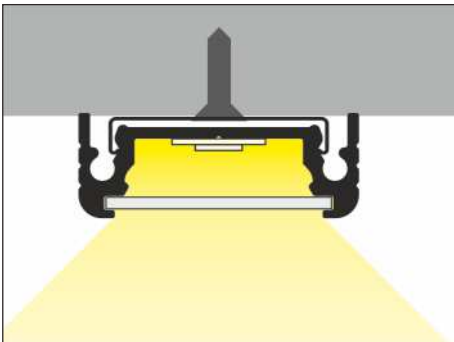
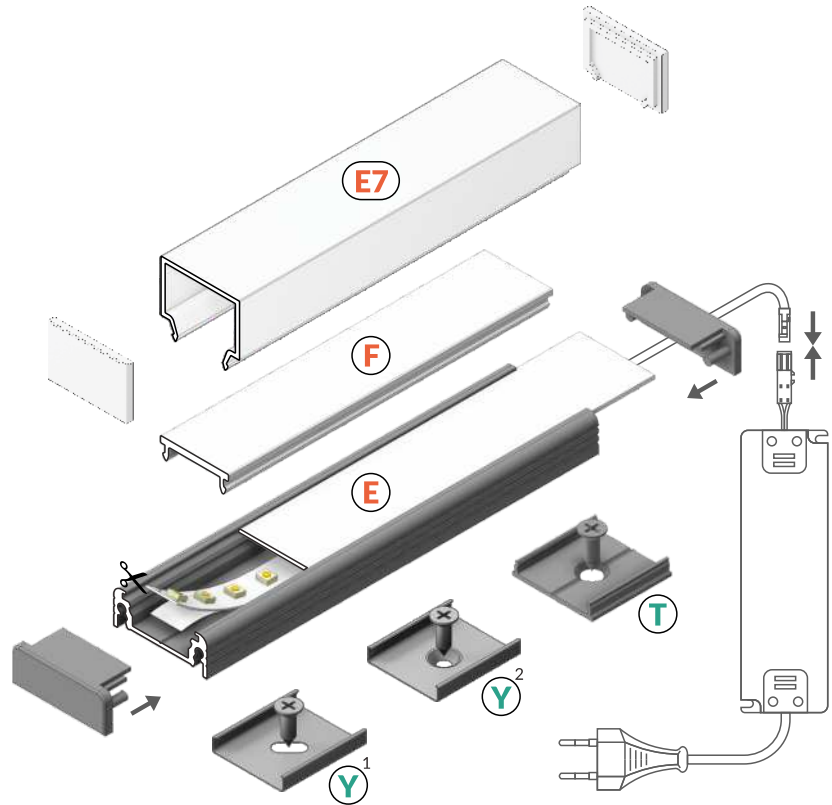

 max 14 mm

 surface  
nawierzchniowy



 white painted  
biały malowany  
A2020001



 anodized  
anodowany  
A2020020



 black anodized  
czarny anodowany  
A2020021



 raw aluminium  
surowe aluminium  
A2020000

INDEX = 1 pc, length 2000 mm  
package = 10 pcs  
INDEKS = 1 szt., długość 2000 mm  
opakowanie = 10 szt.

Available lengths / Dostępne długości  
1000 mm, 2000 mm, 3000 mm, 4000 mm



## COVERS / KLOSZE

**E slide cover**  
colours: transparent, frosted, white  
material: PC, PP, PP

klosz E wsuwany  
kolory: transparentny, szron, mleczny  
materiał: PC, PP, PP



**Note!** Dimensions of the space to install LED source  
**Uwaga!** Wymiary przestrzeni do zamontowania źródła LED

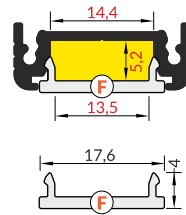
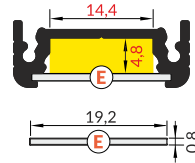

**F click cover**  
colours: transparent, white  
material: PMMA

klosz F klik  
kolory: transparentny, mleczny  
materiał: PMMA

**E7 click cover**  
colour: white  
material: PMMA

klosz E7 klik  
kolor: mleczny  
materiał: PMMA

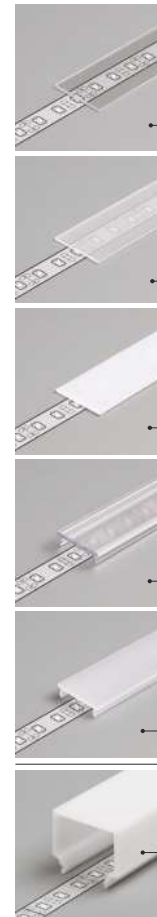
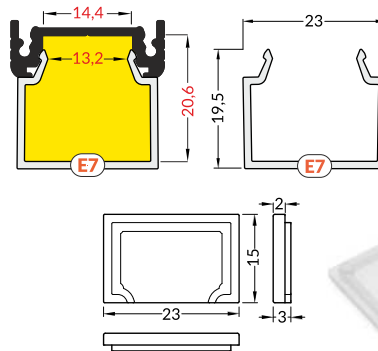

INDEX = 1 pc, length 2000 mm  
package = 10 pcs  
INDEKS = 1 szt., długość 2000 mm  
opakowanie = 10 szt.

E transparent / E transparentny  
A2040016

E frosted / E szron  
A2040039

E white / E mleczny  
A2040038

F transparent / F transparentny  
A2060016

F white / F mleczny  
A2060038

E7 white / E7 mleczny  
C1080038

INDEX = 1 set  
package of 10 sets = 20 pcs  
INDEKS = 1 komplet, opakowanie  
zawiera 10 kompletów = 20 szt.

E7 white ending  
zaślepka E7 mleczny  
C1840038

## MOUNTINGS / MOCOWANIA

**Y flexible mounting plate**  
colour: inox  
material: stainless steel

uchwyt Y sprężysty  
kolor: inox  
materiał: stal nierdzewna

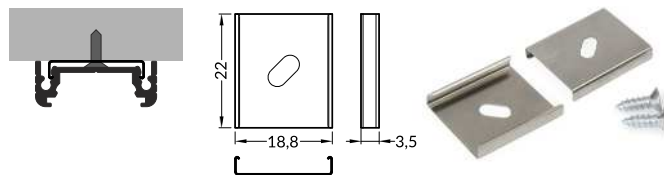

**cone Y flexible mounting plate**  
colour: inox  
material: stainless steel

uchwyt Y sprężysty cone  
kolor: inox  
materiał: stal nierdzewna

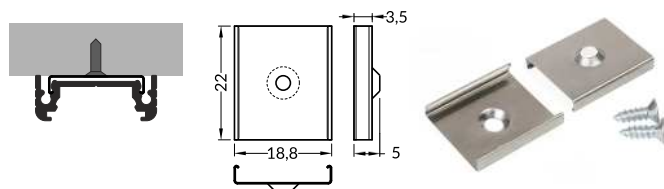

**T mounting plate**  
colour: raw aluminium  
material: aluminium

uchwyt T  
kolor: surowe aluminium  
materiał: aluminium

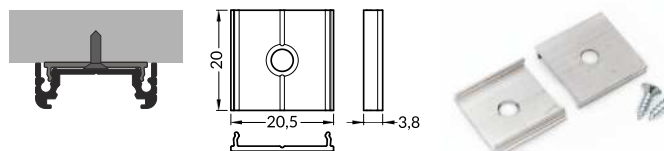

INDEX = 1 set  
package of 10 sets = 20 pcs  
INDEKS = 1 komplet, opakowanie  
zawiera 10 kompletów = 20 szt.

Y flexible mounting plate  
uchwyt Y sprężysty

inox  
inox A2090019

cone Y flexible mounting plate  
uchwyt Y sprężysty cone

inox  
inox A2130019

T mounting plate  
uchwyt T

raw aluminium  
surowe aluminium  
C6960000



## ENDINGS / ZAŚLEPKI

**SURFACE14 ending**  
colours: white, silver, black, grey  
material: ABS

zaślepka SURFACE14  
kolory: biały, srebrny, czarny, szary  
materiał: ABS

**SURFACE14 ending with hole**  
colours: white, silver, black, grey  
material: ABS

zaślepka SURFACE14 z otworem  
kolory: biały, srebrny, czarny, szary  
materiał: ABS

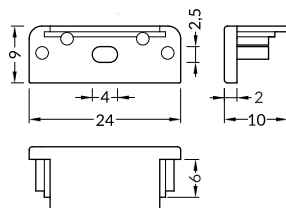

INDEX = 1 set  
package of 10 sets = 20 pcs  
INDEKS = 1 komplet, opakowanie  
zawiera 10 kompletów = 20 szt.

	white białe	
with hole z otworem	A2100001	without hole bez otworu A2070001
	silver srebrne	
with hole z otworem	A2100040	without hole bez otworu A2070040
	black czarne	
with hole z otworem	A2100002	without hole bez otworu A2070002
	grey szare	
with hole z otworem	A2100022	without hole bez otworu A2070022

## CONNECTORS / ŁĄCZNIKI

**T connector**  
colour: raw aluminium  
material: aluminium

łącznik T  
kolor: surowe aluminium  
materiał: aluminium

**SURFACE14 connector 90 deg**  
colours: white, anodized, black  
material: aluminium

łącznik SURFACE14 90 st  
kolory: biały, anodowany, czarny  
materiał: aluminium

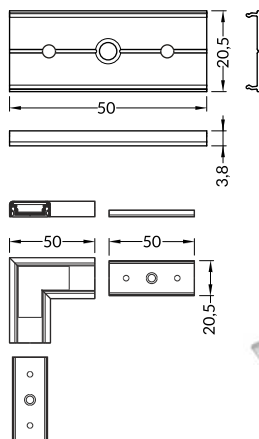

INDEX = 1 set  
INDEKS = 1 komplet

T connector / łącznik T

 raw aluminium  
surowe aluminium  
C6990000

connector 90 deg / łącznik 90 st

	white painted biały malowany
A2990001	
	anodized anodowany
A2990020	
	black anodized czarny anodowany
A2990021	



# LINEA20 EF/TY

## EFFICIENT LUMINAIRE CUT TO SIZE

### WYDAJNA OPRAWA Z METRA

- lighting profile
  - over 20 accessories available
  - possibility of suspension along with the power supply
  - LED modules are assembled with extra clamps
  - angled connections illuminated
  - continuous light line (with 120 P/m LED strip and white cover applied)
  - maximum LED source width: 20 mm
- 
- profil oświetleniowy
  - ponad 20 akcesoriów
  - możliwość zawieszenia na zasilaniu
  - montaż modułów LED dociskiem
  - świecące połączenia kątowe
  - ciągła linia światła (przy użyciu taśm 120 P/m oraz klosza mlecznego)
  - maksymalna szerokość źródła LED: 20 mm

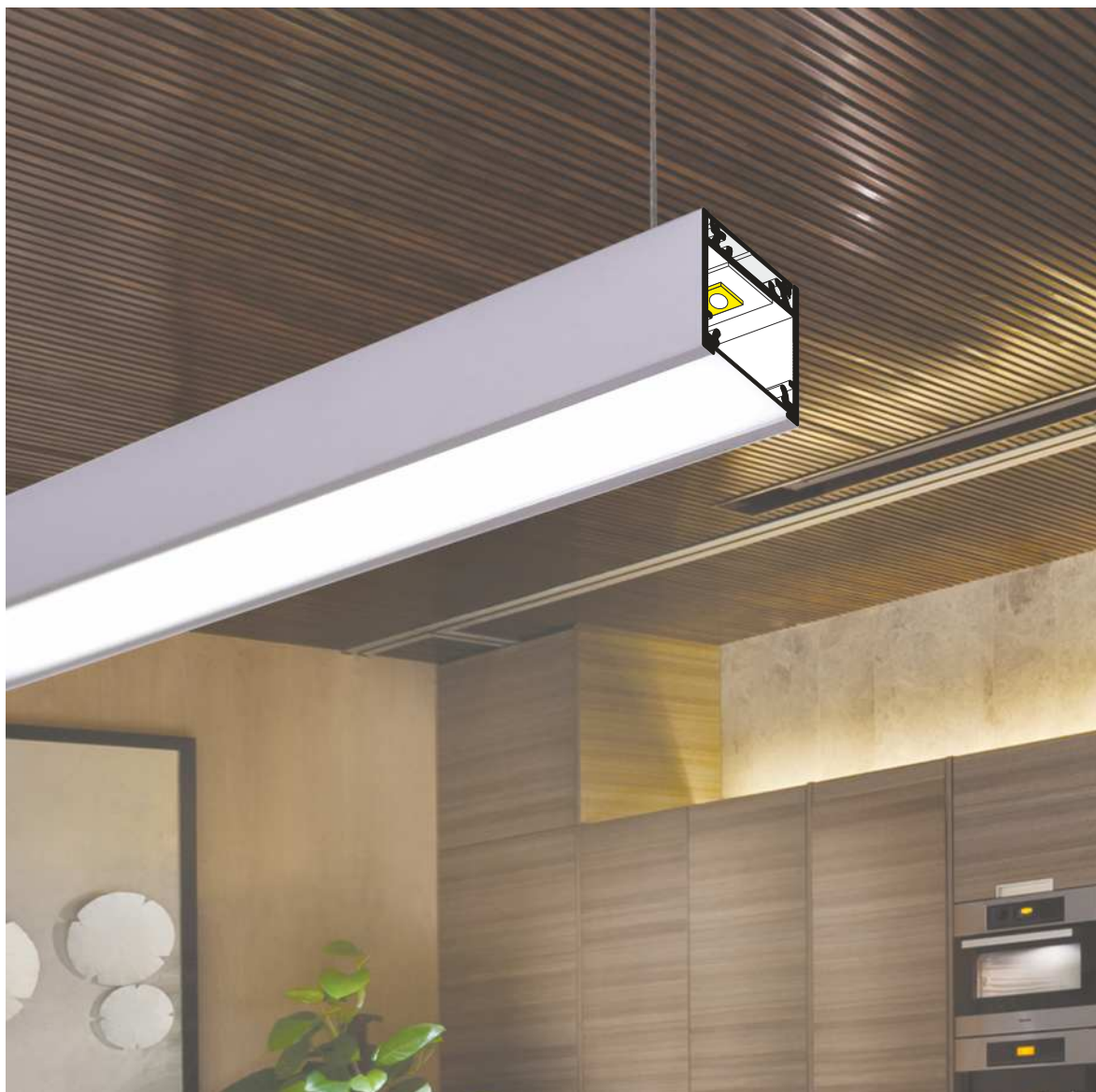

## SIMILAR IN THE OFFER / PODOBNE W OFERCIE



LINEA-IN20  
EF/U7



SURFACE14  
EF/TY



WIDE24  
G/W



VARIO30-01

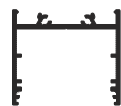

VARIO30-02



**E** **E** slide cover  
klosz **E** wsuwany

**F** **F** click cover  
klosz **F** klik

**E7** **E7** click cover  
klosz **E7** klik

**Y**<sup>1</sup> **Y** flexible mounting plate  
uchwyt **Y** sprężysty

**Y**<sup>2</sup> **cone Y** flexible mounting plate  
uchwyt **Y** sprężysty cone

**T** **T** mounting plate  
uchwyt **T**

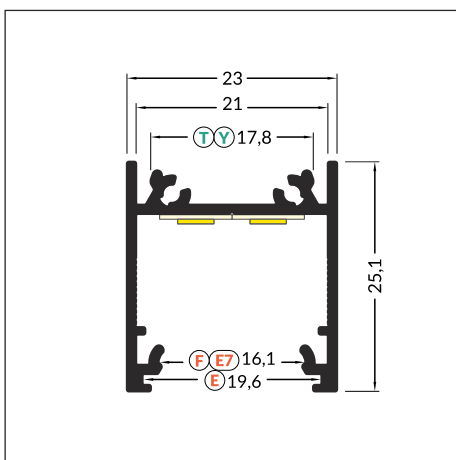
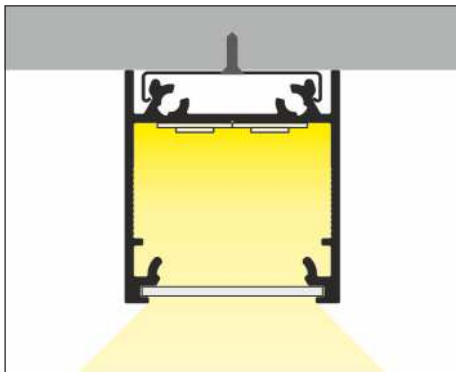
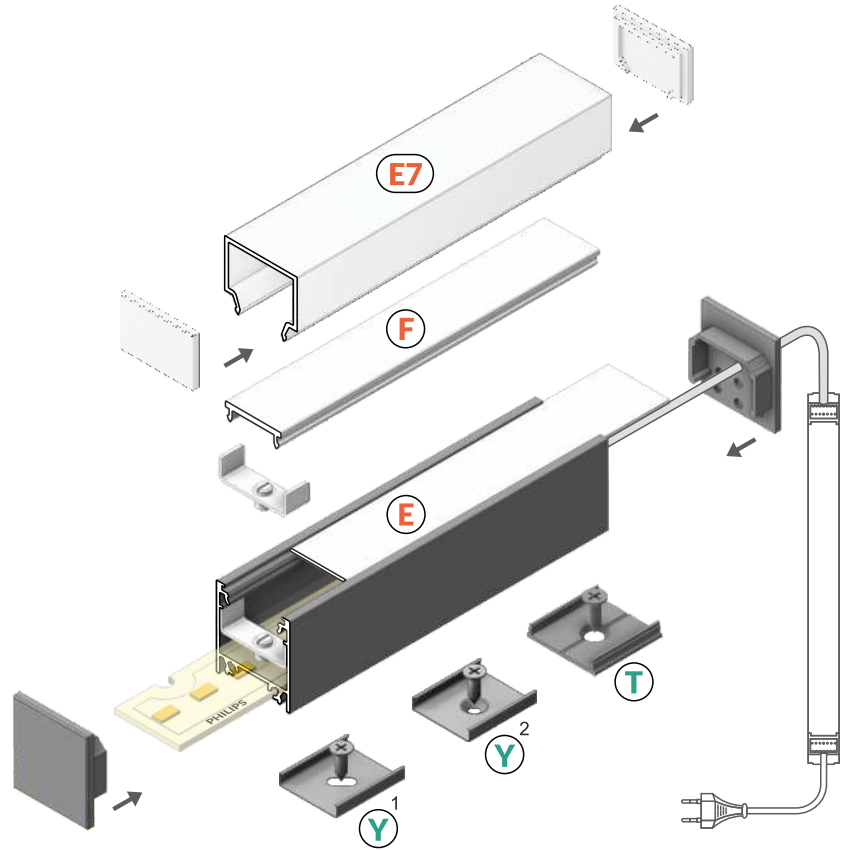

max 20 mm





surface  
nawierzchniowy

INDEX = 1 pc, length 2000 mm  
package = 10 pcs  
INDEKS = 1 szt., długość 2000 mm  
opakowanie = 10 szt.

 white painted  
biały malowany  
C1020001

 anodized  
anodowany  
C1020020

 black anodized  
czarny anodowany  
C1020021

 raw aluminium  
surowe aluminium  
C1020000

Available lengths / Dostępne długości  
1000 mm, 2000 mm, 3000 mm, 4000 mm

# LINEA20 EF/TY

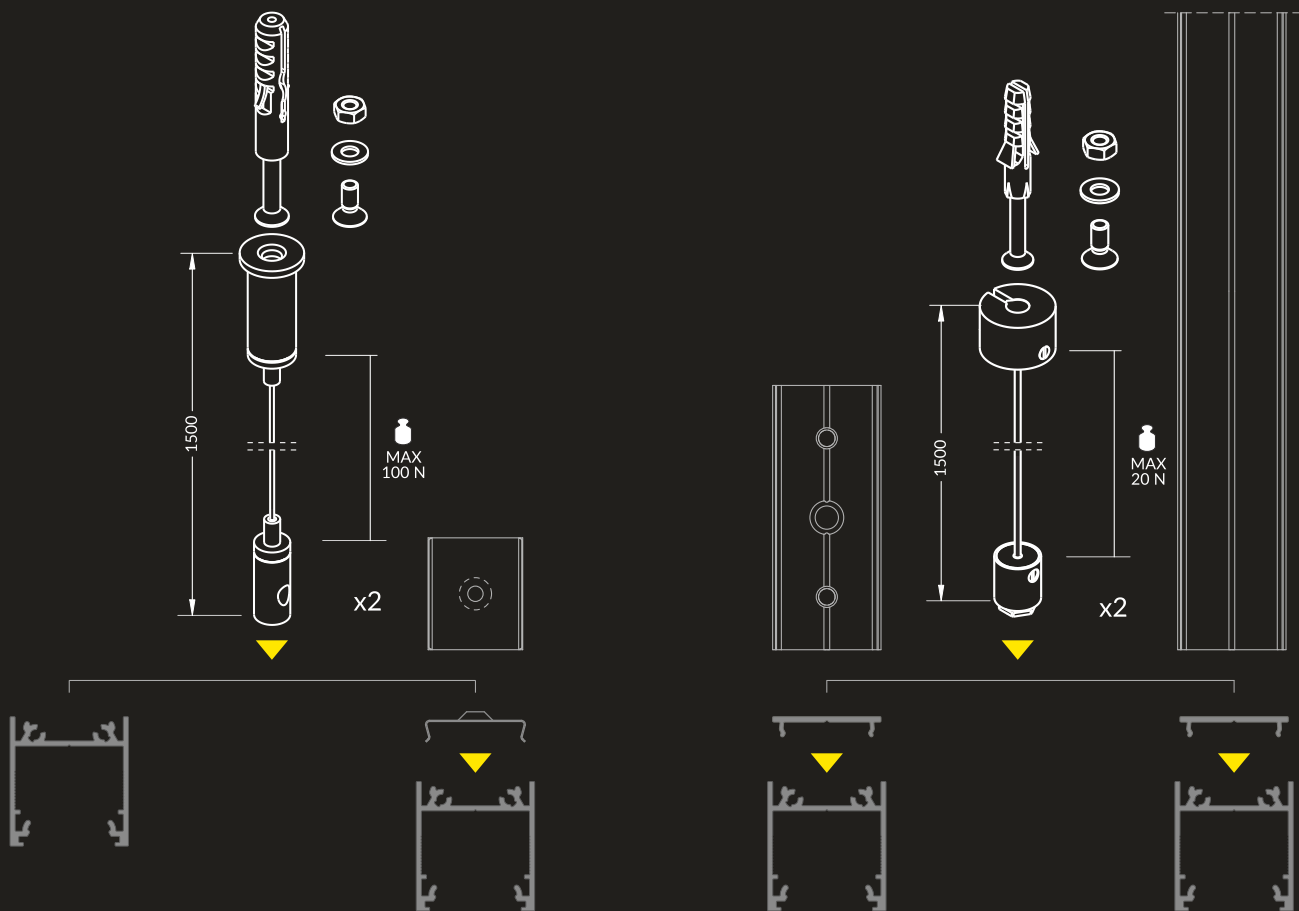

## SLING FOR LED MOUNTING 1500

Compatible with flexible mounting plates, allows fast and easy assembly of the luminaire. Possibility of direct mounting to the profile.

## ZAWIESIE DO UCHWYTU LED 1500

Kompatybilność z uchwytami sprężystymi, pozwala na szybki i łatwy montaż oprawy. Możliwy jest również montaż bezpośrednio do profilu.



## SELV SLING 50 V 1500

It provides a minimalistic look – no additional wires required.

## ZAWIESIE ZASILAJĄCE

SELV 50 V 1500  
Zapewnia minimalistyczny wygląd - bez konieczności doprowadzania dodatkowych przewodów.

Using FIX16 profile creates an aesthetic, closed from the top, luminaire.

Przy zastosowaniu profilu FIX16 tworzymy estetyczną, domkniętą od góry oprawę.

Drill Ø 5 mm mounting holes in FIX16

W profilu FIX16 należy wykonać otwory montażowe Ø 5 mm





## COVERS / KLOSZE

### E slide cover

colours: transparent, frosted, white  
material: PC, PP, PP

klosz E wsuwany  
kolory: transparentny, szron, mleczny  
materiał: PC, PP, PP

### F click cover

colours: transparent, white  
material: PMMA

klosz F klik  
kolory: transparentny, mleczny  
materiał: PMMA

### E7 click cover

colour: white  
material: PMMA

klosz E7 klik  
kolor: mleczny  
materiał: PMMA



**Note!** Dimensions of the space to install LED source  
**Uwaga!** Wymiary przestrzeni do zamontowania źródła LED

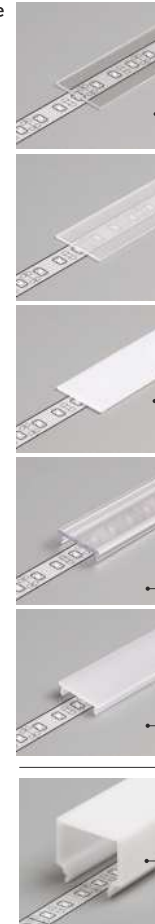
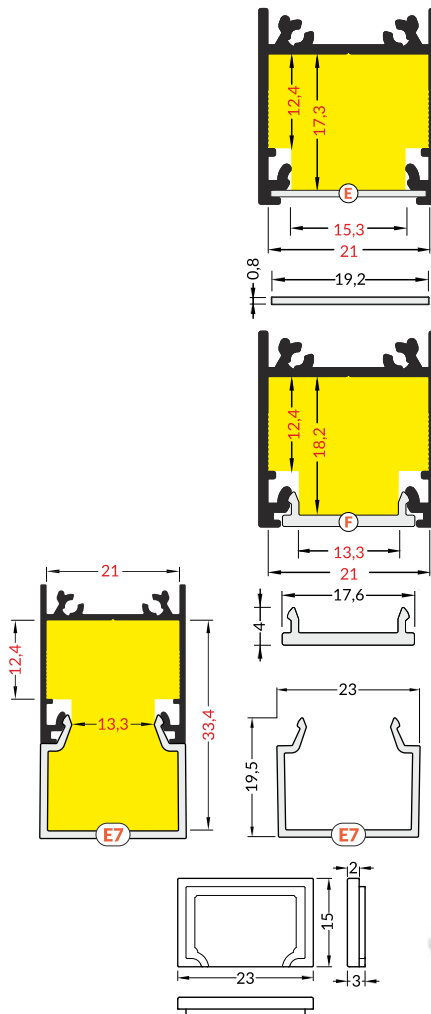

INDEX = 1 pc, length 2000 mm  
package = 10 pcs  
INDEKS = 1 szt., długość 2000 mm  
opakowanie = 10 szt.

E transparent / E transparentny  
A2040016

E frosted / E szron  
A2040039

E white / E mleczny  
A2040038

F transparent / F transparentny  
A2060016

F white / F mleczny  
A2060038

E7 white / E7 mleczny  
C1080038

INDEX = 1 set  
package of 10 sets = 20 pcs  
INDEKS = 1 komplet, opakowanie  
zawiera 10 kompletów = 20 szt.

E7 white ending  
zaślepka E7 mleczny  
C1840038

## SLING / ZAWIESIE

### SELV sling 50 V 1500

colours: white, silver, black

zawiesie SELV 50 V 1500  
kolory: biały, srebrno, czarny

### sling for LED mounting 1500

colour: chrome

zawiesie do uchwytu LED 1500  
kolor: chrom



INDEX = 1 set  
INDEKS = 1 zestaw

SELV sling 50 V 1500  
zawiesie SELV 50 V 1500

white biały 67120001

silver srebrne 67120022

black czarny 67120002

sling for LED mounting 1500  
zawiesie do uchwytu LED 1500

chrome chrom 67140003

## CLAMP / DOCISK

### LINEA20 LED clamp

colour: white  
material: painted steel, plastic

docisk LED LINEA20  
kolor: biały  
materiał: stal malowana,  
tworzywo

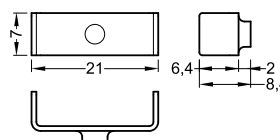
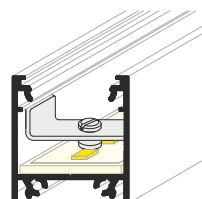

INDEX = 1 set  
package of 10 sets = 20 pcs  
INDEKS = 1 komplet, opakowanie  
zawiera 10 kompletów = 20 szt.

white biały C6940001

# LINEA20 EF/TY

## CONNECTION POSSIBILITY MOŻLIWOŚCI ŁĄCZENIA



60°



90°



120°

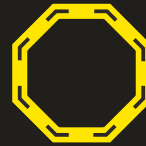

135°



180°

### ANGULAR CONNECTORS

Thanks to five different angle connectors (60° / 90° / 120° / 135° / 180°) it is possible to create many various lighting systems - with no need to cut the profile at an angle.

Bent connectors allows to connect profiles in two planes, at two angles: 90° on the inside and 270° on the outside.

### ŁĄCZNIKI KĄTOWE

Dzięki łącznikom o pięciu różnych kątach (60° / 90° / 120° / 135° / 180°) możliwe jest tworzenie wielu różnych układów oświetlenia bez konieczności cięcia profilu pod skosem.

Łączniki gięte umożliwiają łączenie profili w dwóch płaszczyznach, pod dwoma kątami: wewnętrznym 90° i zewnętrznym 270°.



The component made of clear fabric provides secure connection, letting light through at the same time. Thanks to that, the luminaire can illuminate on the entire surface of the cover - even in the corners.

Element z przejrzystego tworzywa zapewnia stabilizację łączenia, jednocześnie przepuszczając światło. Dzięki temu oprawa może świecić na całej powierzchni klosza - również w rogach.



## CONNECTORS / ŁĄCZNIKI

**LINEA20 connector 60 deg**  
colours: white, anodized, black  
material: aluminium, polycarbonate

łącznik LINEA20 60 st  
kolory: biały, anodowany, czarny  
materiał: aluminium, poliwęglan

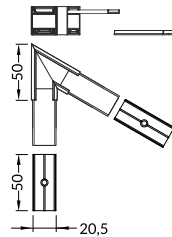

**LINEA20 connector 90 deg**  
colours: white, anodized, black  
material: aluminium, polycarbonate

łącznik LINEA20 90 st  
kolory: biały, anodowany, czarny  
materiał: aluminium, poliwęglan

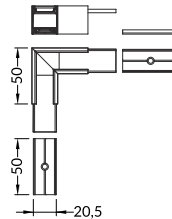

**LINEA20 connector 90 deg bent**  
colours: white, anodized, black  
material: aluminium, polycarbonate

łącznik LINEA20 90 st gięty  
kolory: biały, anodowany, czarny  
materiał: aluminium, poliwęglan

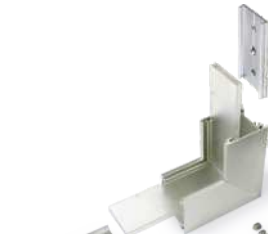
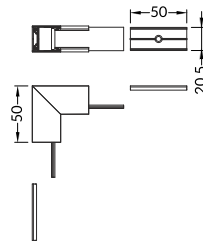

**LINEA20 connector 120 deg**  
colours: white, anodized, black  
material: aluminium, polycarbonate

łącznik LINEA20 120 st  
kolory: biały, anodowany, czarny  
materiał: aluminium, poliwęglan

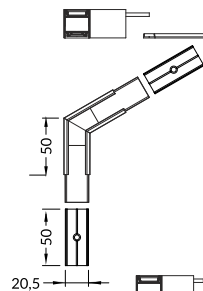

**LINEA20 connector 135 deg**  
colours: white, anodized, black  
material: aluminium, polycarbonate

łącznik LINEA20 135 st  
kolory: biały, anodowany, czarny  
materiał: aluminium, poliwęglan

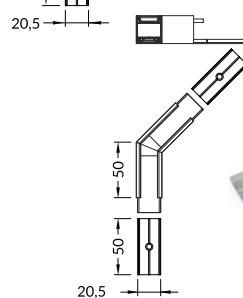

**LINEA20 connector 180 deg**  
material: aluminium, polycarbonate

łącznik LINEA20 180 st  
materiał: aluminium, poliwęglan

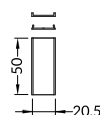

**LINEA20 connector 270 deg bent**  
colours: white, anodized, black  
material: aluminium, polycarbonate

łącznik LINEA20 270 st gięty  
kolory: biały, anodowany, czarny  
materiał: aluminium, poliwęglan

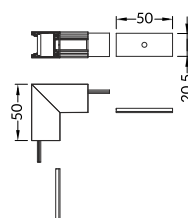

INDEX = 1 set  
INDEKS = 1 zestaw

connector 60 deg  
łącznik 60 st

	white biały	C1850001
	anodized anodowany	C1850020
	black czarny	C1850002

connector 90 deg  
łącznik 90 st

	white biały	C1860001
	anodized anodowany	C1860020
	black czarny	C1860002

connector 90 deg bent  
łącznik 90 st gięty

	white biały	C1870001
	anodized anodowany	C1870020
	black czarny	C1870002

connector 120 deg  
łącznik 120 st

	white biały	C1880001
	anodized anodowany	C1880020
	black czarny	C1880002

connector 135 deg  
łącznik 135 st

	white biały	C1890001
	anodized anodowany	C1890020
	black czarny	C1890002

connector 180 deg  
łącznik 180 st

C1900000

connector 270 deg bent  
łącznik 270 st gięty

	white biały	C1910001
	anodized anodowany	C1910020
	black czarny	C1910002



## MOUNTINGS / MOCOWANIA

### Y flexible mounting plate

colour: inox  
material: stainless steel

uchwyt Y sprężysty

color: inox

materiał: stal nierdzewna

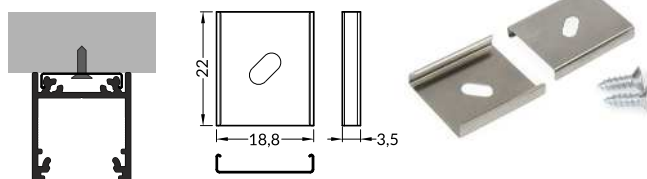

INDEX = 1 set  
package of 10 sets = 20 pcs  
INDEKS = 1 komplet, opakowanie  
zawiera 10 kompletów = 20 szt.

### Y flexible mounting uchwyt Y sprężysty

inox **A2090019**

### cone Y flexible mounting plate

colour: inox  
material: stainless steel

uchwyt Y sprężysty cone

color: inox

materiał: stal nierdzewna

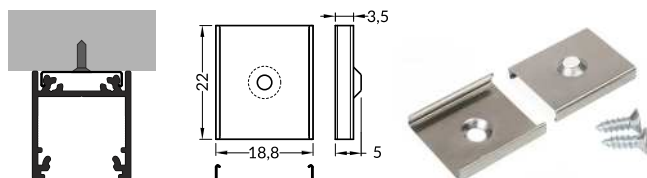

cone Y flexible mounting plate  
uchwyt Y sprężysty cone

inox **A2130019**

### T mounting plate

colour: raw aluminium  
material: aluminium

uchwyt T

color: surowe aluminium

materiał: aluminium

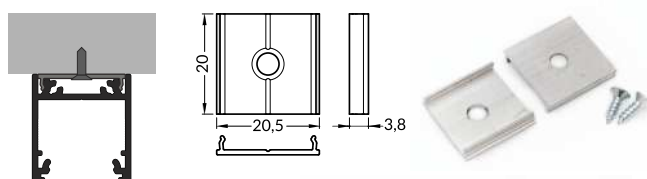

T mounting plate  
uchwyt T

raw aluminium  
surowe aluminium  
**C6960000**

## ENDINGS / ZAŚLEPKI

### LINEA20 ending

colours: white, silver, black, grey  
material: ABS

zaślepka LINEA20

kolory: biały, srebrny, czarny, szary

materiał: ABS

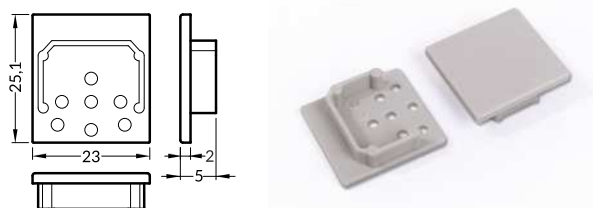

INDEX = 1 set  
package of 10 sets = 20 pcs  
INDEKS = 1 komplet, opakowanie  
zawiera 10 kompletów = 20 szt.

white  
biały **C1940001**

silver  
srebrne **C1940040**

black  
czarny **C1940002**

grey  
szare **C1940022**



Ending with marked space to bore the holes.

Possibility of buying dedicated screws.

Zaślepka z punktami do przewiercenia otworów.

Istnieje możliwość zakupu dedykowanych wkrętów.

### screws for LED endings

colours: white, silver, black, inox

wkręty do zaślepek LED

kolory: biały, srebrny, czarny, inox



INDEX = 1 set  
package of 10 sets = 40 pcs  
INDEKS = 1 komplet, opakowanie  
zawiera 10 kompletów = 40 szt.

white  
biały **B1900001**

silver  
srebrne **B1900040**

black  
czarny **B1900002**

inox  
inox **B1900019**

## ALUMINIUM COVER / OSŁONA ALUMINIOWA

### LED profile FIX16

colours: white, anodized, black, raw aluminium  
material: aluminium

profil LED FIX16

kolory: biały, anodowany, czarny, surowe aluminium

materiał: aluminium

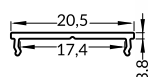

INDEX = 1 pc, length 2000 mm  
package = 10 pcs  
INDEKS = 1 szt., długość 2000 mm  
opakowanie = 10 szt.

white painted  
biały malowany  
**C6020001**

anodized  
anodowany  
**C6020020**

black anodized  
czarny anodowany  
**C6020021**

raw aluminium  
surowe aluminium  
**C6020000**

Available lengths / Dostępne długości  
1000 mm, 2000 mm, 3000 mm, 4000 mm



### CONTINUOUS LIGHT LINE

The LINEA20 180° connector provides an aesthetic, continuous light line of any length.

### CIĄGŁA LINIA ŚWIATŁA

Dzięki wykorzystaniu łącznika LINEA20 180° możliwe jest uzyskanie estetycznej, nieprzerwanej linii światła o dowolnej długości.

## PENDANT LUMINAIRE

Thanks to wide range of profile accessories it could be applied in many arrangements. SELV sling 50 V 1500 and FIX16 closing profile allows to create pendant luminaire with a small intersection, but strong light.

## OPRAWA WISZĄCA

Dzięki licznym akcesoriom profil można zastosować w wielu aranżacjach. Zawiesie SELV 50 V 1500 oraz domykający profil FIX16 pozwalają stworzyć wiszącą oprawę o niewielkim przekroju, ale dającą silne światło.

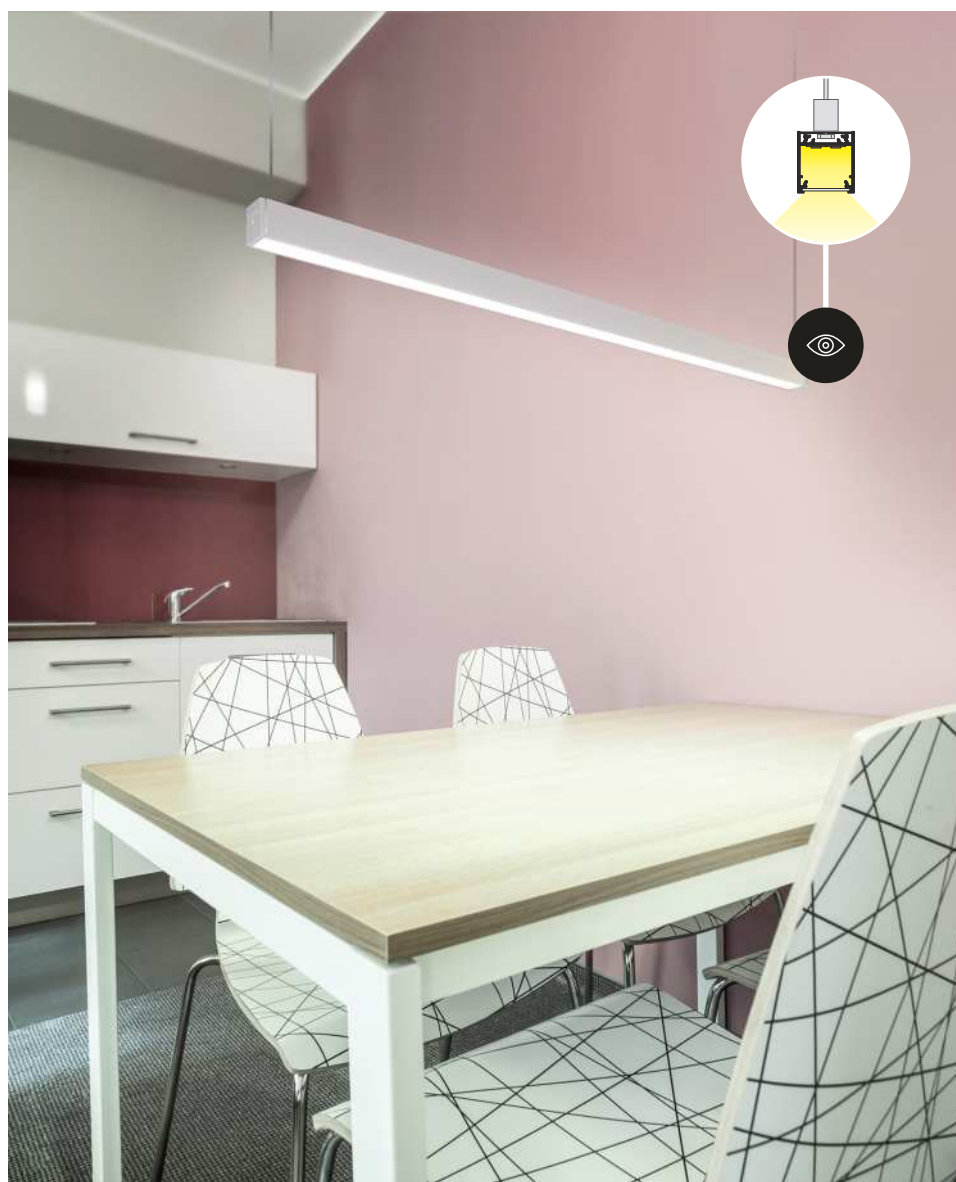

## WIDE, ALUMINIUM, SURFACE PROFILE

### SZEROKI, ALUMINIOWY PROFIL NAWIERZCHNIOWY

- lighting and decorative profile
- possibility of installing 3 8 mm LED strips
- Slick socket
- maximum LED strip width: 24 mm
- profil oświetleniowo-dekoracyjny
- możliwość zastosowania równoległe 3 taśm 8 mm
- gniazdo z funkcją Slick
- maksymalna szerokość taśmy LED: 24 mm



### SIMILAR IN THE OFFER / PODOBNE W OFERCIE

  
SURFACE10  
BC/UX

  
UNI12  
BCD/U

  
BEGTON12  
J/S

  
SURFACE14  
EF/TY

  
LINEA20  
EF/TY

  
VARIO30-02

  
VARIO30-01



**G** slide cover  
klosz G wsuwany

**W** cone W flexible mounting plate  
uchwyt W sprężysty cone

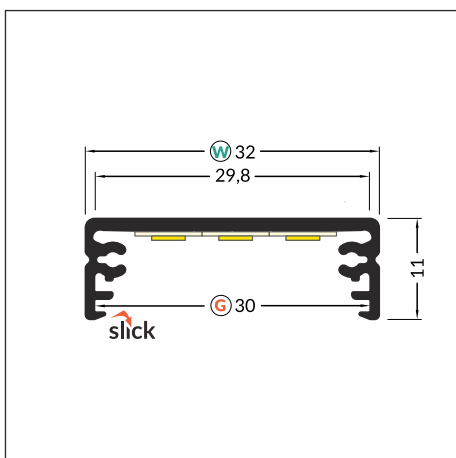
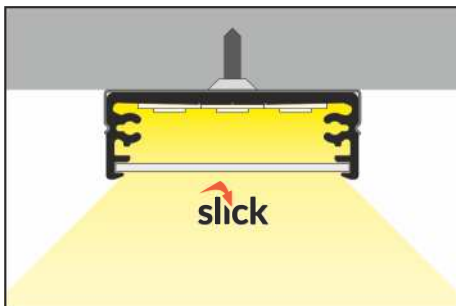
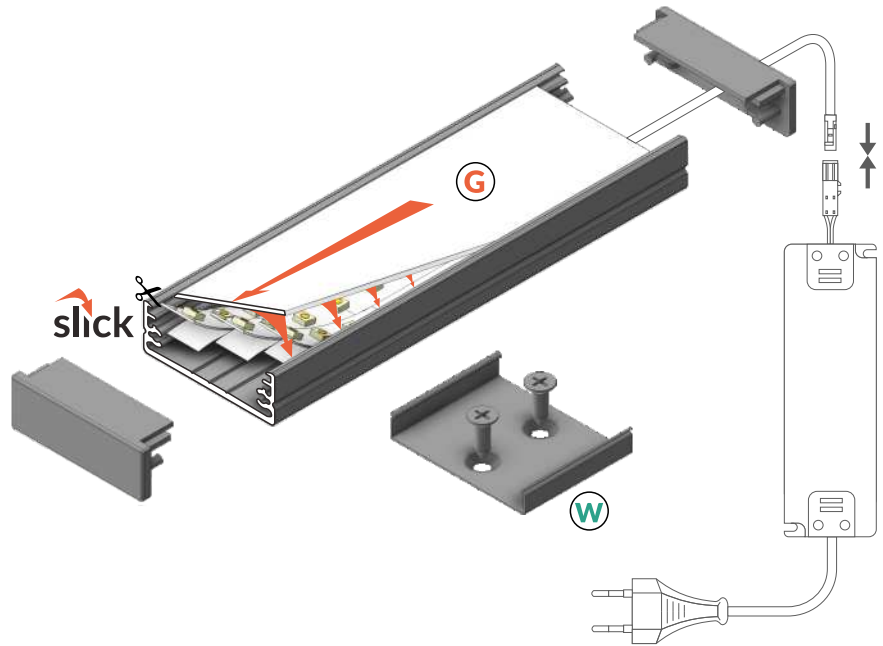

white painted  
biały malowany  
84030001



anodized  
anodowany  
84030020



black anodized  
czarny anodowany  
84030021



raw aluminium  
surowe aluminium  
84030000

 max 24 mm

 surface  
nawierzchniowy

Available lengths / Dostępne długości  
1000 mm, 2000 mm, 3000 mm, 4000 mm



## COVERS / KLOSZE

**G slide cover**  
colours: transparent, frosted, white  
material: PC, PP, PP

klosz G wsuwany  
kolory: transparentny, szron, mleczny  
materiał: PC, PP, PP



**Note!** Dimensions of the space to install LED source  
**Uwaga!** Wymiary przestrzeni do zamontowania źródła LED

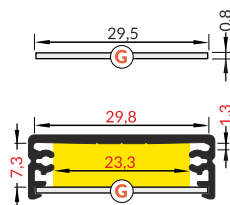

INDEX = 1 pc, length 2000 mm  
package = 10 pcs  
INDEKS = 1 szt., długość 2000 mm  
opakowanie = 10 szt.

G transparent / G transparentny  
84070016

G frosted / G szron  
84070039

G white / G mleczny  
84070038

## ENDINGS / ZAŚLEPKI

**WIDE24 ending**  
colours: white, silver, black, grey  
material: ABS

zaślepka WIDE24  
kolory: biały, srebrny, czarny, szary  
materiał: ABS

**WIDE24 ending with hole**  
colours: white, silver, black, grey  
material: ABS

zaślepka WIDE24 z otworem  
kolory: szary, czarny, biały, srebrny  
materiał: ABS

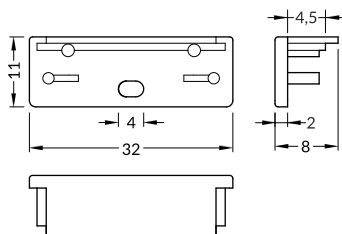

INDEX = 1 set  
package of 10 sets = 20 pcs  
INDEKS = 1 komplet, opakowanie  
zawiera 10 kompletów = 20 szt.

white  
białe

with hole z otworem  
84300001

without hole bez otworu  
84040001

silver  
srebrne

with hole z otworem  
84300040

without hole bez otworu  
84040040

black  
czarne

with hole z otworem  
84300002

without hole bez otworu  
84040002

grey  
szare

with hole z otworem  
84300022

without hole bez otworu  
84040022

## MOUNTINGS / MOCOWANIA

**cone W flexible mounting plate**  
colour: inox  
material: stainless steel

uchwyt W sprężysty cone  
kolor: inox  
materiał: stal nierdzewna

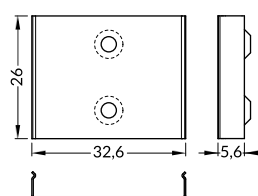
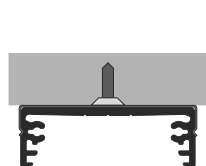

INDEX = 1 set  
package of 10 sets = 20 pcs  
INDEKS = 1 komplet  
opakowanie zawiera 10 kpl = 20 szt.

cone W flexible mounting plate  
uchwyt W sprężysty cone

white painted  
biały malowany 84510001

inox  
inox 84510019

black painted  
czarny malowany 84510002

**WIDE24 simple holder**  
material: zinc coated steel

uchwyt WIDE24 prosty  
materiał: stal ocynkowana

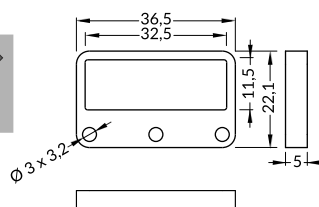
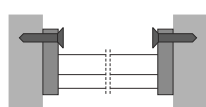

INDEX = 1 set = 2 pcs  
INDEKS = 1 komplet = 2 szt.

simple holder  
uchwyt prosty

zinc coated  
stal ocynkowana  
84220030





## SLING / ZAWIESIE

**SELV sling 50 V 1500**  
colours: white, silver, black

zawiesie SELV 50 V 1500  
kolory: biały, srebrny, czarny

**sling for LED mounting 1500**  
colour: chrome

zawiesie do uchwytu LED 1500  
kolor: chrom



INDEX = 1 set  
INDEKS = 1 zestaw

SELV sling 50 V 1500  
zawiesie SELV 50 V 1500

 white  
biały 67120001

 silver  
srebrny 67120022

 black  
czarny 67120002

sling for LED mounting 1500  
zawiesie do uchwytu LED 1500

 chrome  
chrom 67140003







**RECESSED  
WPUSTOWE**

**2017**

**LED profiles  
profile LED**

# FLAT8 H/UX

## FLAT RECESSED PROFILE EMITTING DIFFUSED LIGHT GLOW

### PŁASKI, WPUSTOWY PROFIL EMITUJĄCY ROZPROSZONĄ ŁUNĘ ŚWIATŁA

- decorative and lighting profile
- a parabolic, reflecting element - even, smooth, diffused light
- a flat profile, designed to fit into plasterboards - installation without interference in the frame construction
- mounted to furniture, walls, pedestals with holders (click-in) or directly (with screws, adhesive tape or glue)
- maximum LED strip width: 8 mm
- profil dekoracyjno-oświetleniowy
- paraboliczny odbłyśnik - równomierne, gładkie, rozproszone światło
- płaski profil mieszczący się w grubości płyty karton-gips, montaż bez ingerencji w stelaż zabudowy
- montaż do mebli, ścian, cokołów za pomocą uchwytów (wklikując) lub bezpośrednio (przykręcając lub wklejając)
- maksymalna szerokość taśmy LED: 8 mm



### SIMILAR IN THE OFFER / PODOBNE W OFERCIE

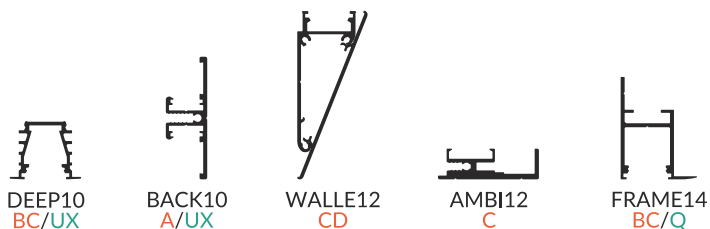



**H** slide cover  
klosz H wsuwany

**U**<sup>1</sup> flexible mounting plate  
uchwyt U sprężysty

**U**<sup>2</sup> cone U flexible mounting plate  
uchwyt U sprężysty cone

**X**<sup>1</sup> X mounting plate  
uchwyt X

**X**<sup>2</sup> spring X mounting plate  
uchwyt X sprężyna

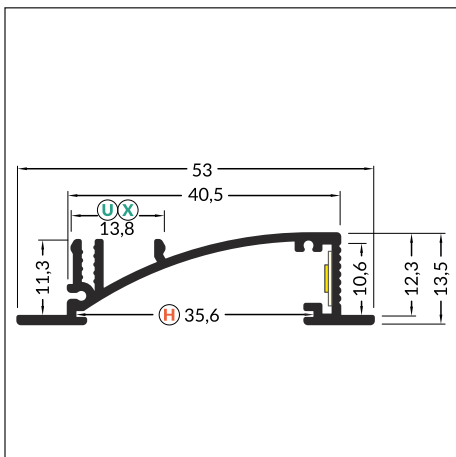
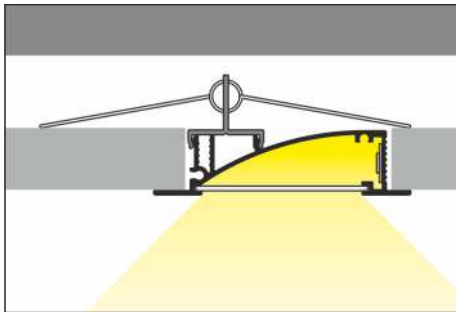
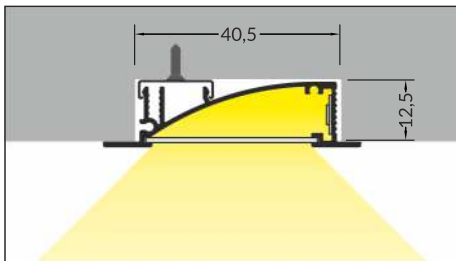
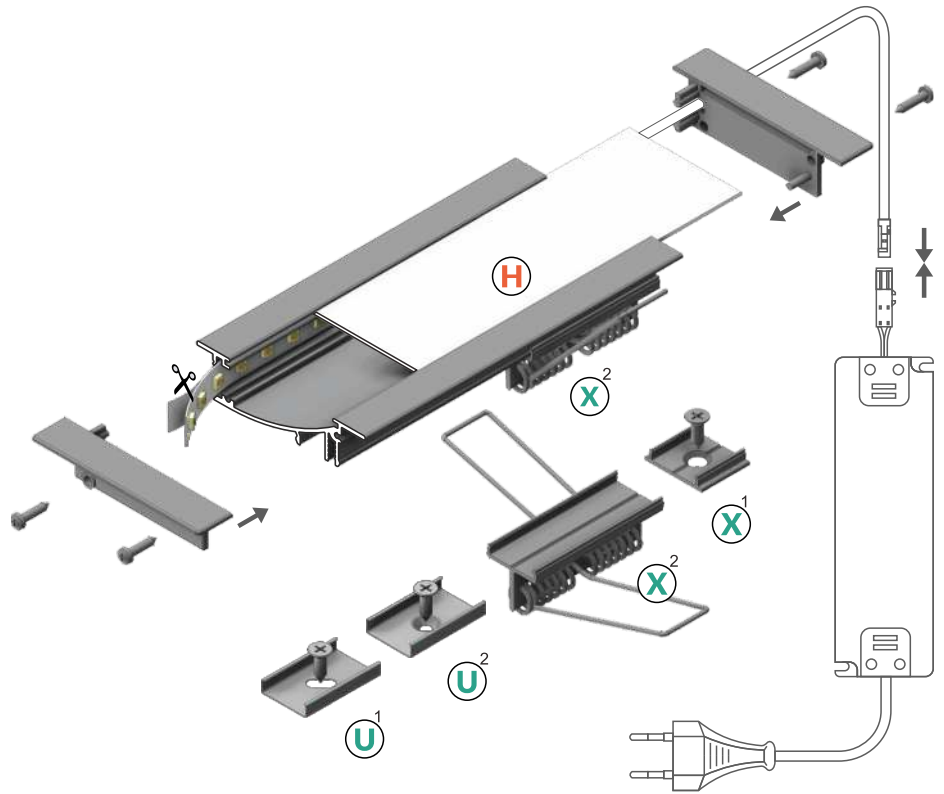

max 8 mm

recessed  
wpustowy



INDEX = 1 pc, length 2000 mm  
package = 10 pcs  
INDEKS = 1 szt., długość 2000 mm  
opakowanie = 10 szt.

white painted  
biały malowany  
23050001

anodized  
anodowany  
23050020

black anodized  
czarny anodowany  
23050021

raw aluminium  
surowe aluminium  
23050000



Available lengths / Dostępne długości  
1000 mm, 2000 mm, 3000 mm, 4000 mm



## COVERS / KLOSZE

**H slide cover**  
colours: transparent, frosted, white  
material: PC, PP, PP

klosz **H** wsuwany  
kolory: transparentny, szron, mleczny  
materiał: PC, PP, PP



**Note!** Dimensions of the space to install LED source  
**Uwaga!** Wymiary przestrzeni do zamontowania źródła LED

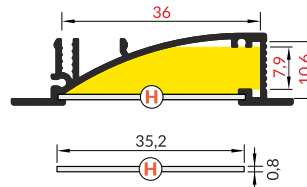

INDEX = 1 pc, length 2000 mm  
package = 10 pcs  
INDEKS = 1 szt., długość 2000 mm  
opakowanie = 10 szt.

**H transparent / H transparentny**  
23080016

**H frosted / H szron**  
23080039

**H white / H mleczny**  
23080038

## ENDINGS / ZAŚLEPKI

**FLAT8 ending with hole**  
colours: white, silver, black, grey  
material: ABS

zaślepka FLAT8 z otworem  
kolory: biały, srebrny, czarny, szary  
materiał: ABS

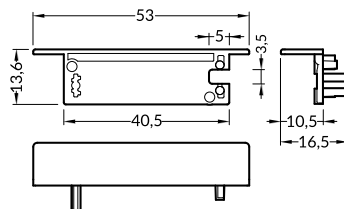

INDEX = 1 set,  
package of 10 sets = 20 pcs  
INDEKS = 1 komplet, opakowanie  
zawiera 10 kompletów = 20 szt.

white  
białe 23110001

silver  
srebrne 23110040

black  
czarne 23110002

grey  
szare 23110022

## MOUNTINGS / MOCOWANIA

**U flexible mounting plate**  
colour: inox  
material: stainless steel

uchwyt **U** sprężysty  
kolor: inox  
materiał: stal nierdzewna

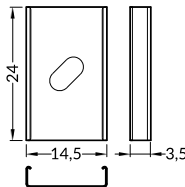
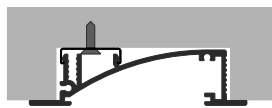

INDEX = 1 set  
package of 10 sets = 20 pcs  
INDEKS = 1 komplet  
opakowanie zawiera 10 kpl = 20 szt

**U flexible mounting plate**  
uchwyt **U** sprężysty

inox  
inox 76380000

**cone U flexible mounting plate**  
colour: inox  
material: stainless steel

uchwyt **U** sprężysty cone  
kolor: inox  
materiał: stal nierdzewna

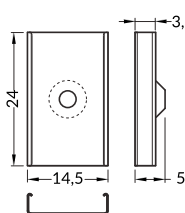
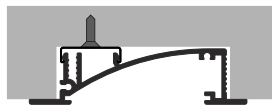

**cone U flexible mounting plate**  
uchwyt **U** sprężysty cone

inox  
inox 76620000

**X mounting plate**  
colour: raw aluminium  
material: aluminium

uchwyt **X**  
kolor: surowe aluminium  
materiał: aluminium

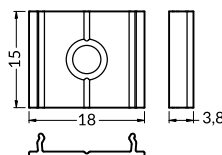
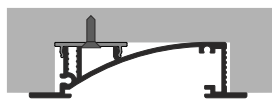

**X mounting plate**  
uchwyt **X**

raw aluminium  
surowe aluminium 76260000

**spring X mounting plate**  
colour: raw aluminium  
material: aluminium

uchwyt **X** sprężyna  
kolor: surowe aluminium  
materiał: aluminium

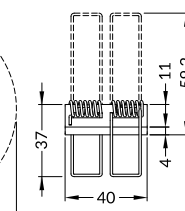
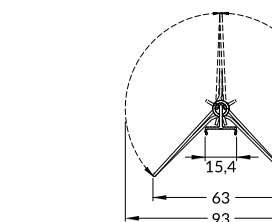

INDEX = 1 pc  
INDEKS = 1 szt.

**spring X mounting plate**  
uchwyt **X** sprężyna

raw aluminium  
surowe aluminium 23130000



## CONNECTORS / ŁĄCZNIKI

**X connector**  
colour: raw aluminium  
material: aluminium

łącznik X  
kolor: surowe aluminium  
materiał: aluminium

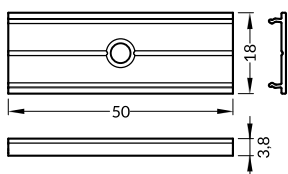

INDEX = 1 set  
INDEKS = 1 komplet

raw aluminium  
surowe aluminium  
76350000

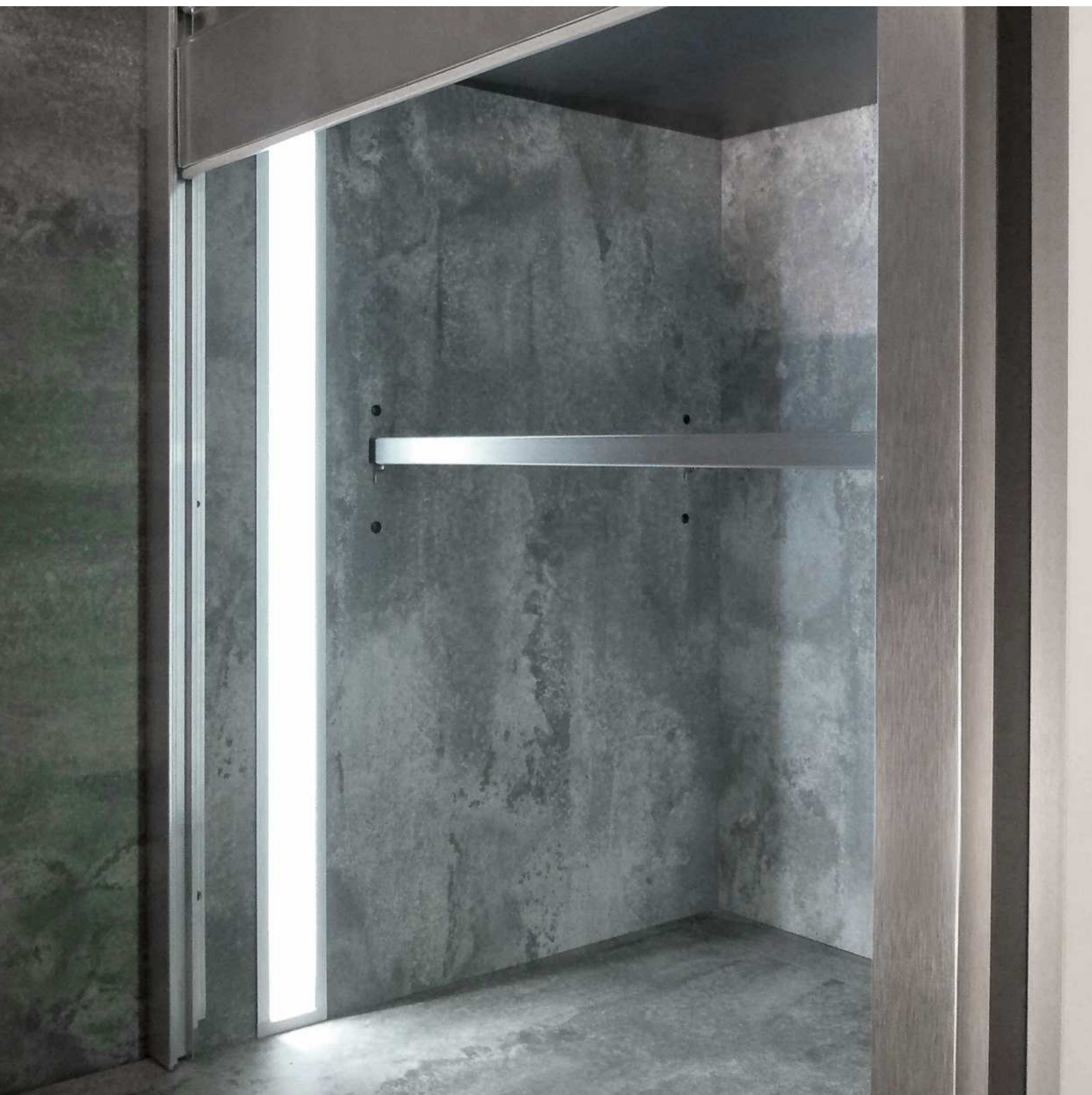

# DEEP10 BC/UX

A RECESSED PROFILE WHICH CAN GIVE A CONTINUOUS LINE EFFECT

PROFIL WPUSTOWY Z MOŻLIWOŚCIĄ UZYSKANIA CIĄGŁEJ LINII

- decorative and lighting profile
- mainly used in furniture or plasterboard
- continuous line of light (when using LED strip 120 P/m and white cover)
- angled profile sides are designed for better light reflection
- maximum LED strip width: 10 mm

- profil dekoracyjno-oświetleniowy
- zastosowanie głównie meblowe lub w płycie karton-gips
- ciągła linia światła przy użyciu taśmy 120 P/m i klosza mlecznego
- ścianki profilu ustawione pod kątem działające jak odbłyśnik
- maksymalna szerokość taśmy LED: 10 mm

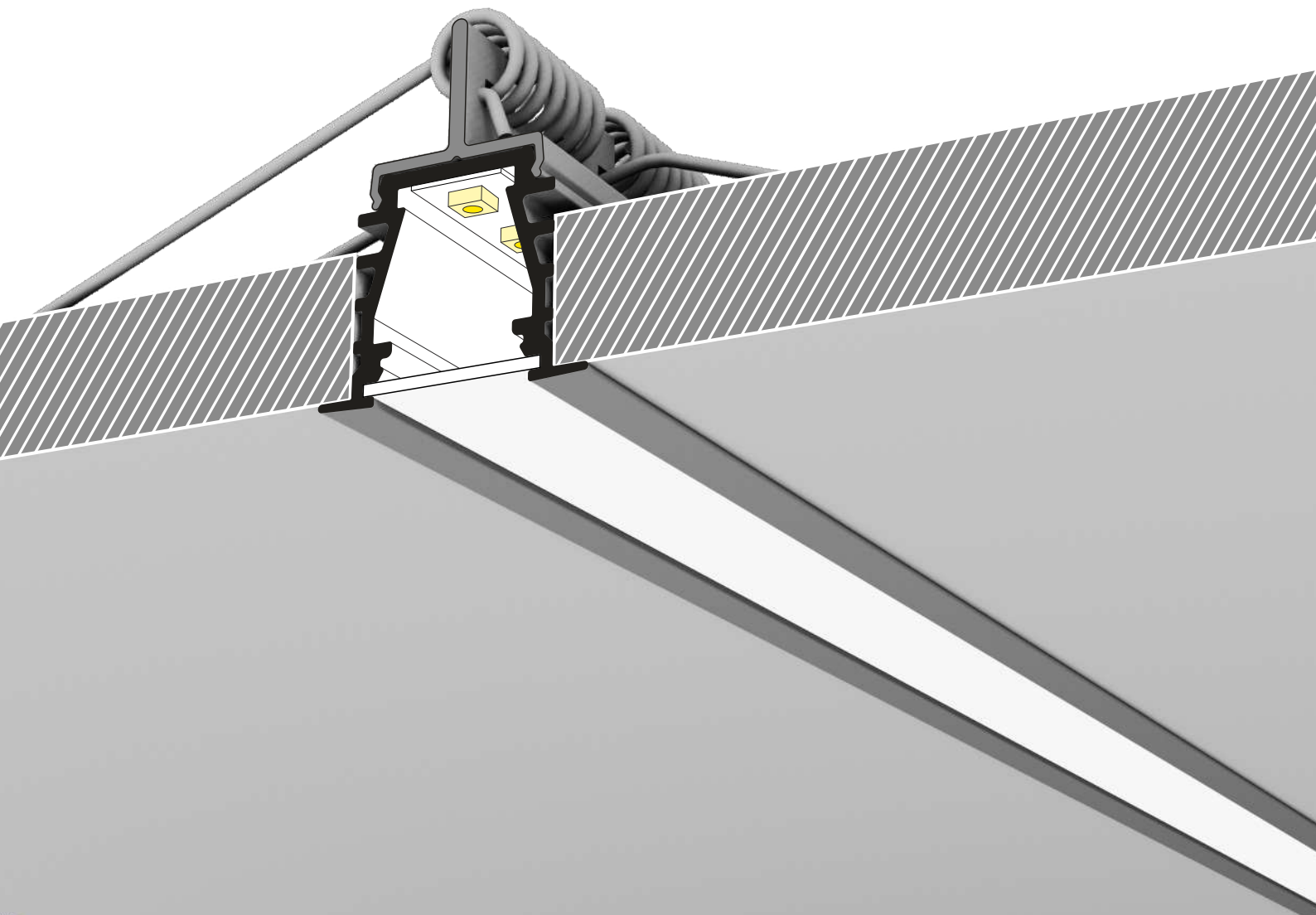

SIMILAR IN THE OFFER / PODOBNE W OFERCIE



FLAT8  
H/UX



BEGTIN12  
J/S



GROOVE10  
BC/UX



UNI12  
BCD/U



GROOVE14  
EF/TY





**B** slide cover  
klosz B wsuwany

**C** click cover  
klosz C klik

**C** lens cover  
klosz C soczewka

**U**<sup>1</sup> flexible mounting plate  
uchwyt U sprężysty

**U**<sup>2</sup> cone U flexible mounting plate  
uchwyt U sprężysty cone

**U**<sup>3</sup> rack U flexible mounting plate  
uchwyt U sprężysty rack

**X**<sup>1</sup> X mounting plate  
uchwyt X

**X**<sup>2</sup> spring X mounting plate  
uchwyt X sprężyna

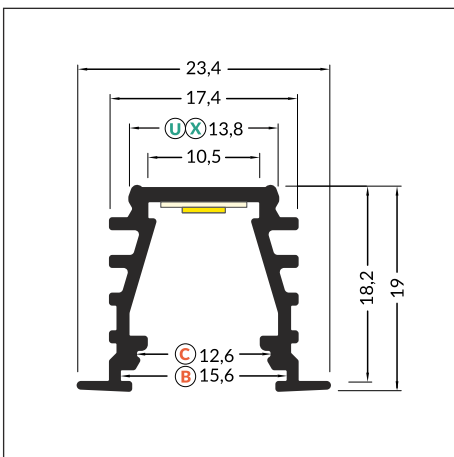
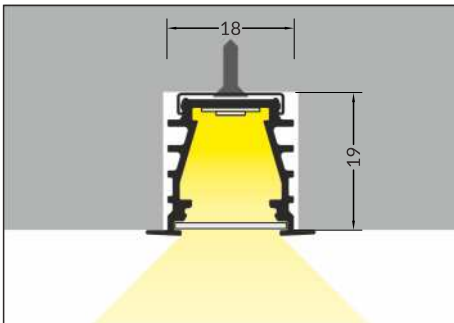
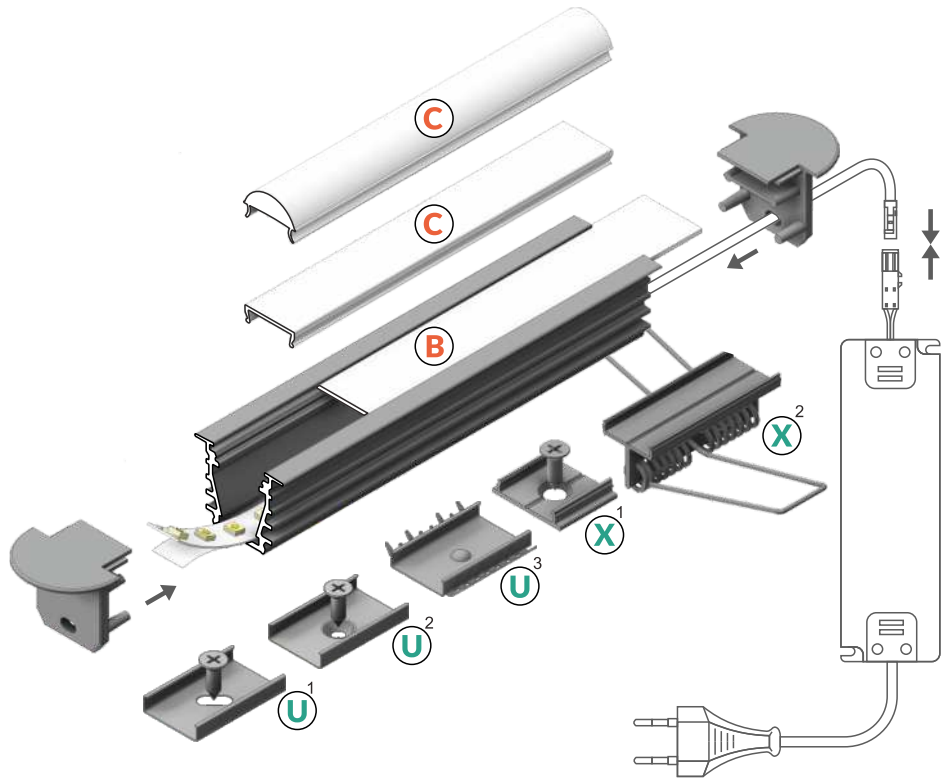



 max 10 mm

 recessed  
wpustowy

INDEX = 1 pc, length 2000 mm  
package = 10 pcs  
INDEKS = 1 szt., długość 2000 mm  
opakowanie = 10 szt.

 white painted  
biały malowany  
96030001

 anodized  
anodowany  
96030020

 black anodized  
czarny anodowany  
96030021

 raw aluminium  
surowe aluminium  
96030000

Available lengths / Dostępne długości  
1000 mm, 2000 mm, 3000 mm, 4000 mm



## COVERS / KLOSZE

### B slide cover

colours: transparent, frosted, white  
material: PC, PP, PP

klosz B wsuwany  
kolory: transparentny, szron, mleczny  
materiał: PC, PP, PP



**Note!** Dimensions of the space to install LED source  
**Uwaga!** Wymiary przestrzeni do zamontowania źródła LED

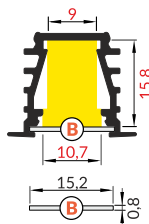

### C click cover

colours: transparent, white  
material: PMMA

klosz C klik  
kolory: transparentny, mleczny  
materiał: PMMA

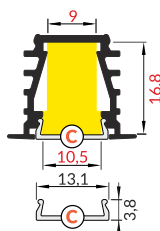

### C lens click cover

colour: transparent  
material: PC

klosz C klik soczewka  
kolor: transparentny  
materiał: PC

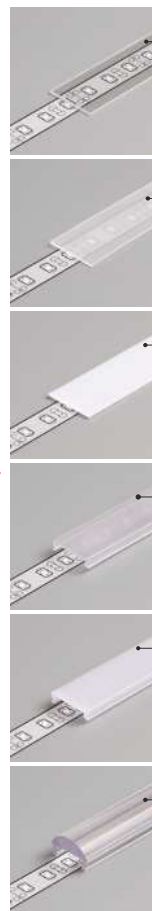
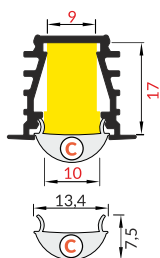

INDEX = 1 pc, length 2000 mm  
package = 10 pcs  
INDEKS = 1 szt., długość 2000 mm  
opakowanie = 10 szt.

B transparent / B transparentny  
76250016

B frosted / B szron  
76250039

B white / B mleczny  
76250038

C transparent / C transparentny  
76330000

C white / C mleczny  
76330038

C lens / C soczewka  
76300000

## ENDINGS / ZAŚLEPKI

DEEP10 ending with hole  
colours: white, silver, black, grey  
material: ABS

zaślepka DEEP10 z otworem  
kolory: biały, srebrny, czarny, szary  
materiał: ABS

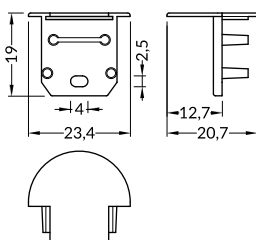

INDEX = 1 set,  
package of 10 sets = 20 pcs  
INDEKS = 1 komplet, opakowanie  
zawiera 10 kompletów = 20 szt.

white / biały 96070001

silver / srebrne 96070040

black / czarne 96070002

grey / szare 96070022

## CONNECTORS / ŁĄCZNIKI

### X connector

colour: raw aluminium  
material: aluminium

łącznik X  
kolor: surowe aluminium  
materiał: aluminium

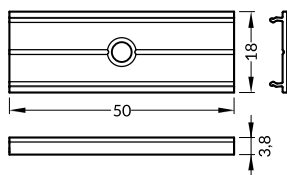

INDEX = 1 set  
INDEKS = 1 komplet

raw aluminium / surowe aluminium  
76350000



## MOUNTINGS / MOCOWANIA

**U flexible mounting plate**  
colour: inox  
material: stainless steel

uchwyt U sprężysty  
kolor: inox  
materiał: stal nierdzewna

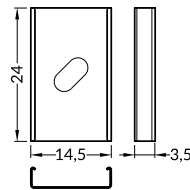
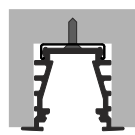

INDEX = 1 set  
package of 10 sets = 20 pcs  
INDEKS = 1 komplet  
opakowanie zawiera 10 kpl = 20 szt

U flexible mounting plate  
uchwyt U sprężysty

inox  
inox  
76380000

**cone U flexible mounting plate**  
colour: inox  
material: stainless steel

uchwyt U sprężysty cone  
kolor: inox  
materiał: stal nierdzewna

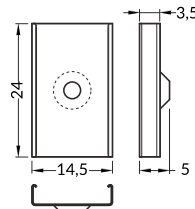

cone U flexible mounting plate  
uchwyt U sprężysty cone

inox  
inox  
76620000

**rack U flexible mounting plate**  
colour: inox  
material: stainless steel

uchwyt U sprężysty rack  
kolor: inox  
materiał: stal nierdzewna

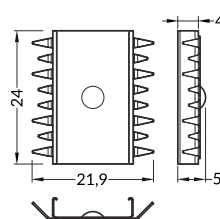

rack U flexible mounting plate  
uchwyt U sprężysty rack

inox  
inox  
76610019

**X mounting plate**  
colour: raw aluminium  
material: aluminium

uchwyt X  
kolor: surowe aluminium  
materiał: aluminium

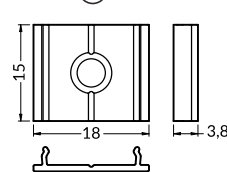

X mounting plate  
uchwyt X

raw aluminium  
surowe aluminium  
76260000

**spring X mounting plate**  
colour: raw aluminium  
material: aluminium

uchwyt X sprężyna  
kolor: surowe aluminium  
materiał: aluminium

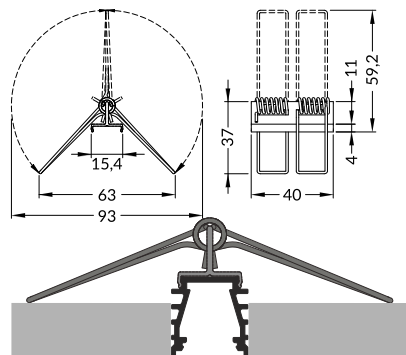

INDEX = 1 pc  
INDEKS = 1 szt.

spring X mounting plate  
uchwyt X sprężyna

raw aluminium  
surowe aluminium  
23130000



# GROOVE10 BC/UX

## RECESSED ALUMINIUM PROFILE

### ALUMINIOWY PROFIL WPUSTOWY

- used mainly in furniture
- ceiling installation possible
- decorative and lighting profile
- 6 types of covers
- maximum LED strip width: 10 mm
- głównie do zastosowania meblowego
- możliwe zastosowanie sufitowe
- profil dekoracyjno-oświetleniowy
- 6 rodzajów kloszy
- maksymalna szerokość taśmy LED: 10 mm



## SIMILAR IN THE OFFER / PODOBNE W OFERCIE



DEEP10  
BC/UX



TRIO10  
BC



BEGTIN12  
J/S



UNI12  
BCD/U



GROOVE14  
EF/TY



- B** slide cover  
klosz B wsuwany
- C** click cover  
klosz C klik
- C** lens cover  
klosz C soczewka
- U<sup>1</sup>** U flexible mounting plate  
uchwyt U sprężysty
- U<sup>2</sup>** cone U flexible mounting plate  
uchwyt U sprężysty cone
- U<sup>3</sup>** rack U flexible mounting plate  
uchwyt U sprężysty rack
- X<sup>1</sup>** X mounting plate  
uchwyt X

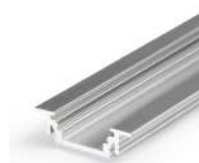
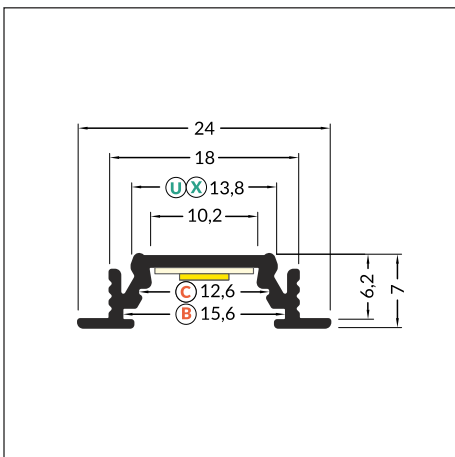
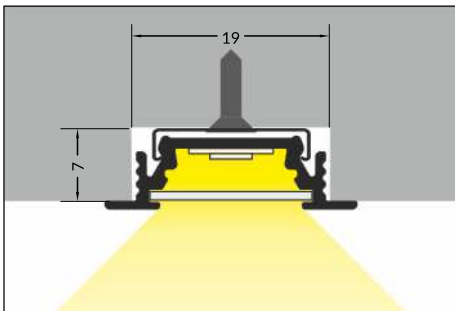
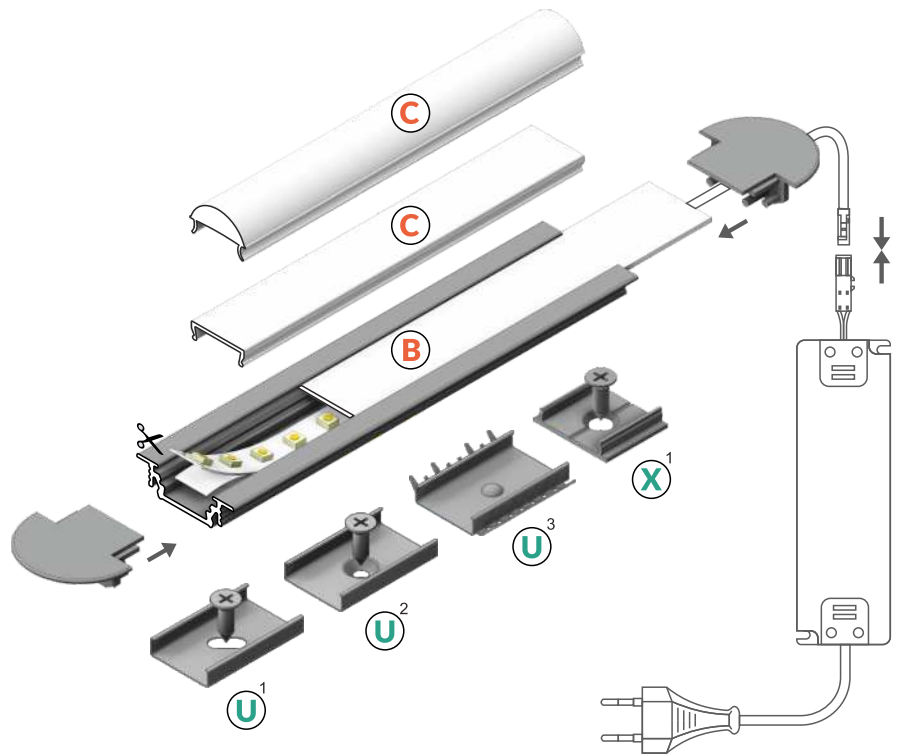

INDEX = 1 pc, length 2000 mm  
package = 10 pcs  
INDEKS = 1 szt., długość 2000 mm  
opakowanie = 10 szt.

 white painted  
biały malowany  
76210001

 anodized  
anodowany  
76210020

 black anodized  
czarny anodowany  
76210021

 raw aluminium  
surowe aluminium  
76210000

 max 10 mm

 recessed  
wpustowy

Available lengths / Dostępne długości  
1000 mm, 2000 mm, 3000 mm, 4000 mm



## COVERS / KLOSZE

### B slide cover

colours: transparent, frosted, white  
material: PC, PP, PP

klosz B wsuwany  
kolory: transparentny, szron, mleczny  
materiał: PC, PP, PP

### C click cover

colours: transparent, white  
material: PMMA

klosz C klik  
kolory: transparentny, mleczny  
materiał: PMMA

### C click cover lens

colour: transparent  
material: PC

klosz C klik soczewka  
kolor: transparentny  
materiał: PC



**Note!** Dimensions of the space needed to install LED source  
**Uwaga!** Wymiary przestrzeni do zamontowania źródła LED

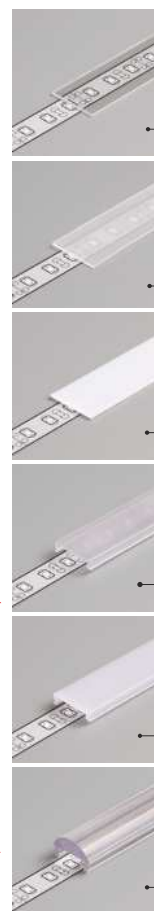
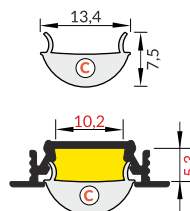
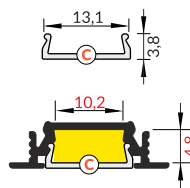
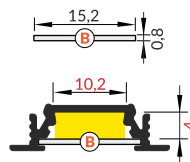

INDEX = 1 pc, length 2000 mm  
package = 10 pcs  
INDEKS = 1 szt., długość 2000 mm  
opakowanie = 10 szt.

B transparent / B transparentny  
76250016

B frosted / B szron  
76250039

B white / B mleczny  
76250038

C transparent / C transparentny  
76330000

C white / C mleczny  
76330038

C lens / C soczewka  
76300000

## ENDINGS / ZAŚLEPKI

endings GROOVE10 with hole  
colours: white, silver, black, grey  
material: ABS

zaślepka GROOVE10 z otworem  
kolory: biały, srebrny, czarny, szary  
materiał: ABS

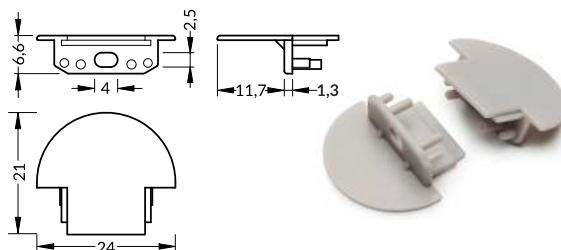

INDEX = 1 set,  
package of 10 sets = 20 pcs  
INDEKS = 1 komplet, opakowanie  
zawiera 10 kompletów = 20 szt.

white  
białe 76480001

silver  
srebrne 76480040

black  
czarne 76480002

grey  
szare 76480022

## CONNECTORS / ŁĄCZNIKI

X connector  
colour: raw aluminium  
material: aluminium

łącznik X  
kolor: surowe aluminium  
materiał: aluminium

GROOVE10 L connector  
colours: white, anodized, black  
material: aluminium

łącznik L GROOVE10  
kolory: biały, anodowany, czarny  
materiał: aluminium

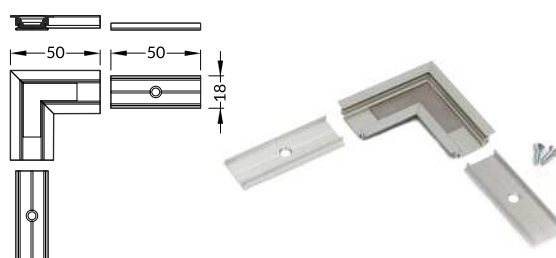
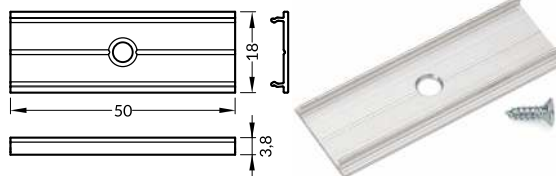

INDEX = 1 set  
INDEKS = 1 komplet

X connector  
łącznik X

raw aluminium  
surowe aluminium  
76350000

L connector  
łącznik L

white painted  
biały malowany  
76530001

anodized  
anodowany  
76530020

black anodized  
czarny anodowany  
76530021



## MOUNTINGS / MOCOWANIA

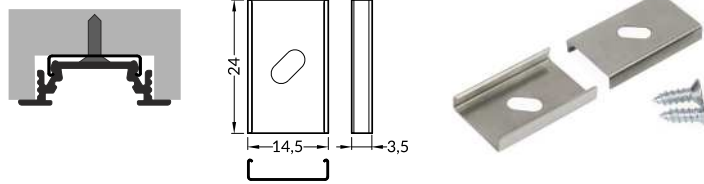

**U flexible mounting plate**  
colours: inox  
material: stainless steel

uchwyt U sprężysty  
kolory: inox  
materiał: stal nierdzewna



INDEX = 1 set  
package of 10 sets = 20 pcs  
INDEKS = 1 komplet  
opakowanie zawiera 10 kpl = 20 szt

U flexible mounting plate  
uchwyt U sprężysty



 inox 76380000  
 inox

**cone U flexible mounting plate**  
colours: inox  
material: stainless steel

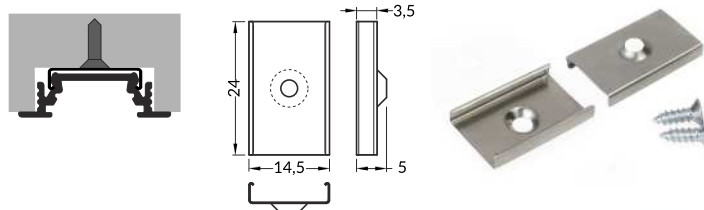
uchwyt U sprężysty cone  
kolory: inox  
materiał: stal nierdzewna



cone U flexible mounting plate  
uchwyt U sprężysty cone



 inox 76620000  
 inox

**rack U flexible mounting plate**  
colours: inox  
material: stainless steel

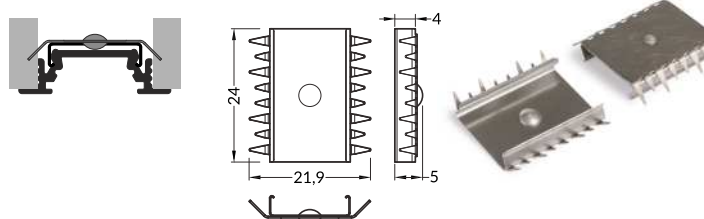
uchwyt U sprężysty rack  
kolory: inox  
materiał: stal nierdzewna



rack U flexible mounting plate  
uchwyt U sprężysty rack

 inox 76610019  
 inox

**X mounting plate**  
colours: raw aluminium  
material: aluminium

uchwyt X  
kolory: surowe aluminium  
materiał: aluminium

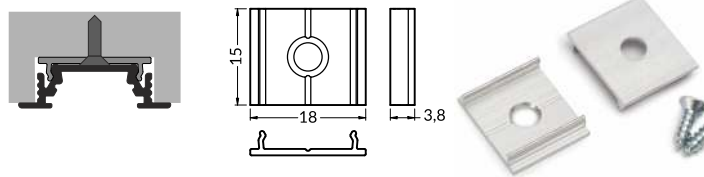

X mounting plate  
uchwyt X

 raw aluminium  
surowe aluminium  
76260000

**spring X mounting plate**  
colours: raw aluminium  
material: aluminium

uchwyt X sprężyna  
kolory: surowe aluminium  
materiał: aluminium

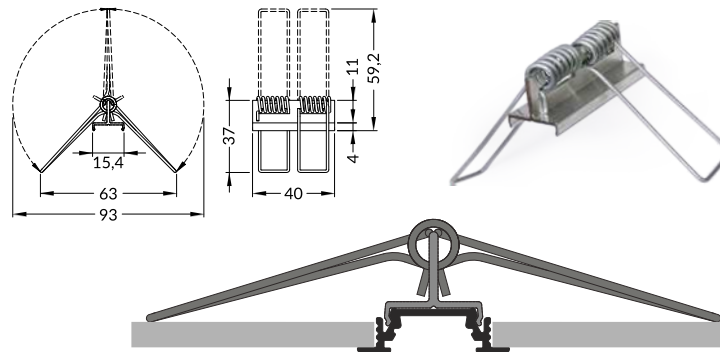

INDEX = 1 pc  
INDEKS = 1 szt.

spring X mounting plate  
uchwyt X sprężyna

 raw aluminium  
surowe aluminium  
23130000



## CONTINUOUS LIGHT LINE IN SMALL RECESSED PROFILE

### CIĄGŁA LINIA ŚWIATŁA W MAŁYM PROFILU WPUSTOWYM

- suitable for use in plasterboards - does not affect the structure of the board
- used also in furniture
- continuous line of light (when using LED strip 120 p/m and white cover)
- SLICK socket
- miniature dimensions
- maximum width of LED strip: 10 mm

- do zastosowania w płycie gipsowo-kartonowej - nie narusza konstrukcji płyty
- również do zastosowania meblowego
- ciągła linia światła (przy zastosowaniu taśmy 120 P/m i klosza mlecznego)
- gniazdo Slick
- miniaturowe gabaryty
- maksymalna szerokość taśmy LED: 10 mm

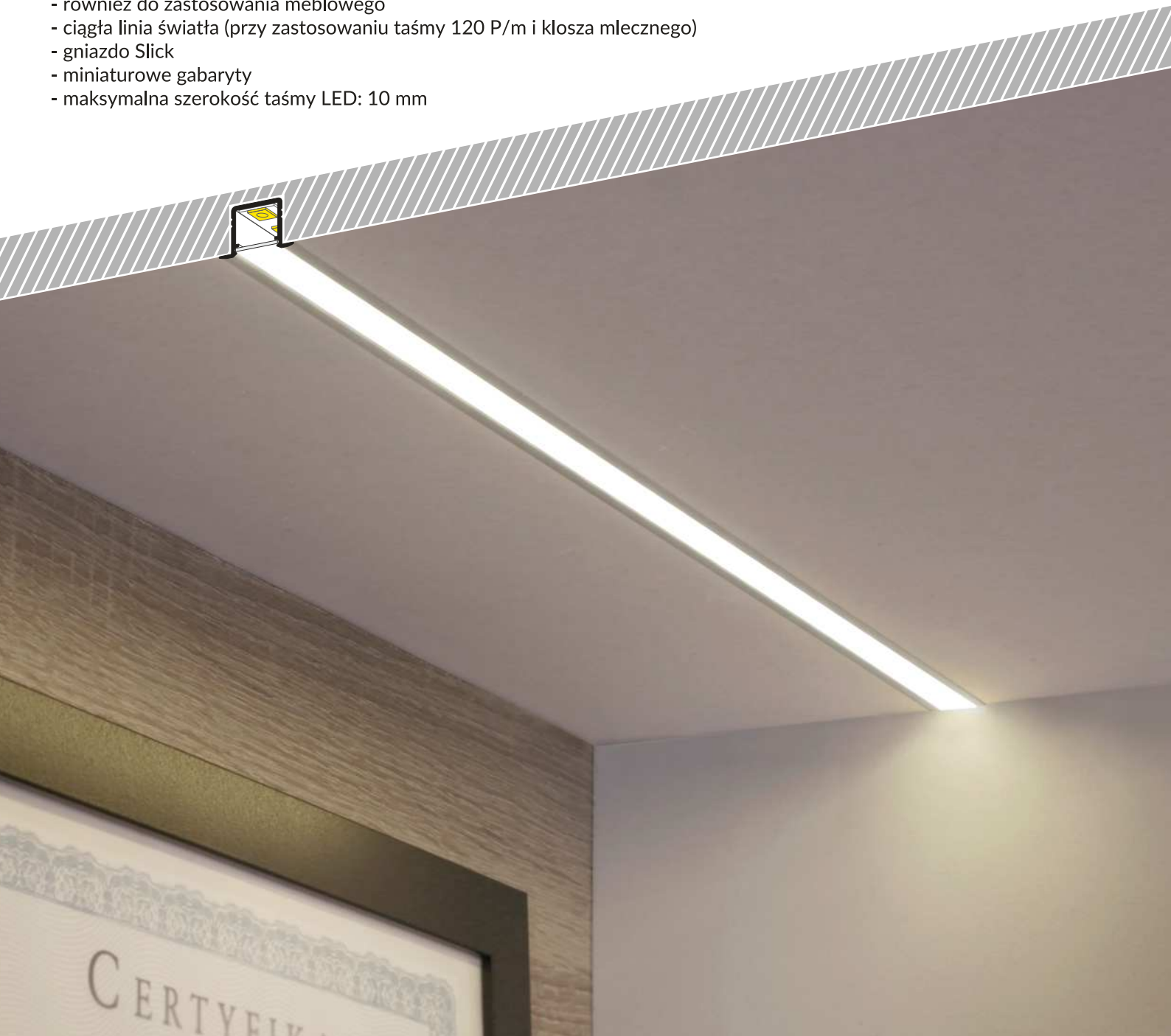

## SIMILAR IN THE OFFER / PODOBNE W OFERCIE



DEEP10  
BC/UX



SMART10  
A/Z



GROOVE10  
BC/UX



BEGTIN12  
J/S



UNI12  
BCD/U



GROOVE14  
EF/TY





- A** slide cover  
klosz A wsuwany
- Z**<sup>1</sup> flexible mounting plate  
uchwyt Z sprężysty
- Z**<sup>2</sup> cone Z flexible mounting plate  
uchwyt Z sprężysty cone

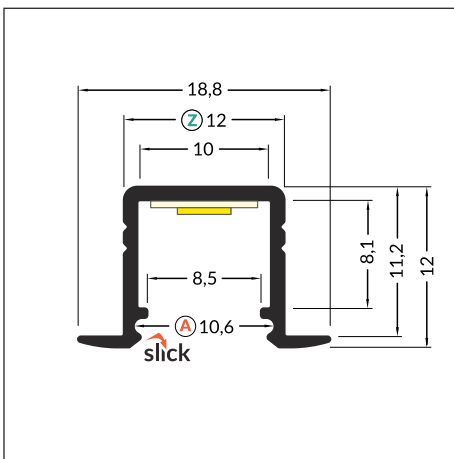
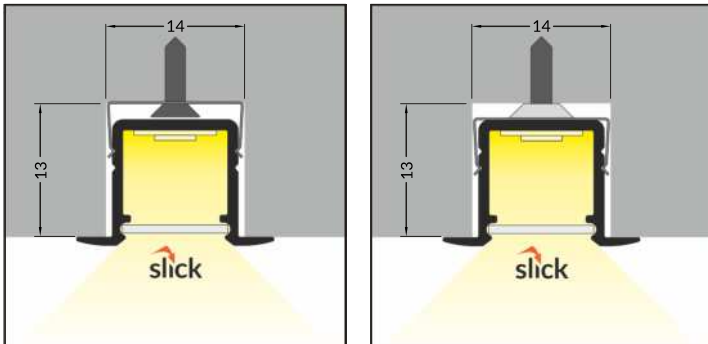
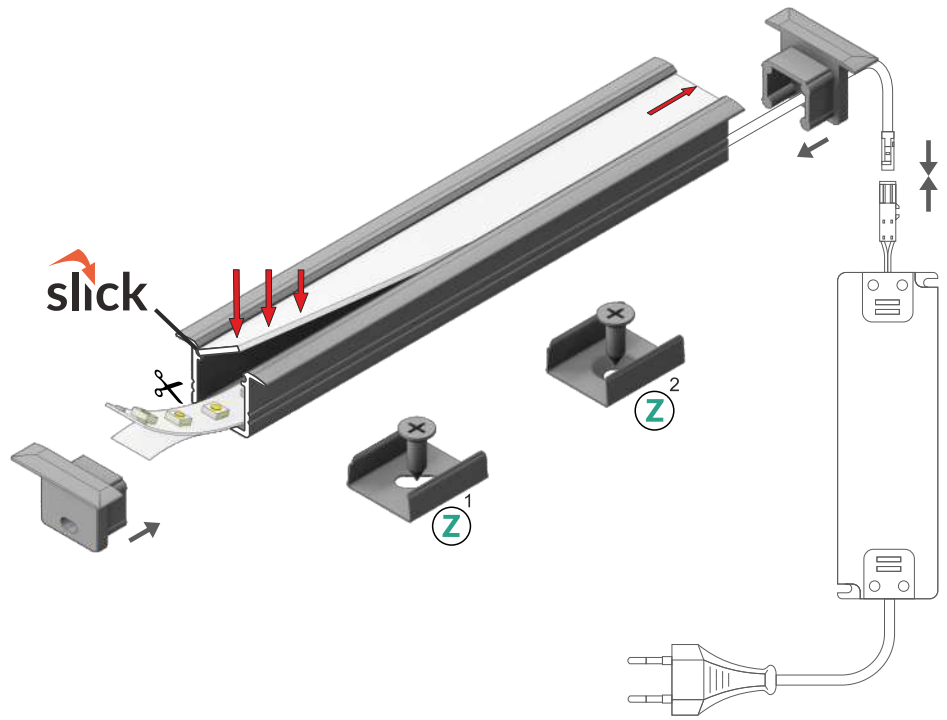

○ white painted  
biały malowany  
**E3020001**



● anodized  
anodowany  
**E3020020**



● black anodized  
czarny anodowany  
**E3020021**

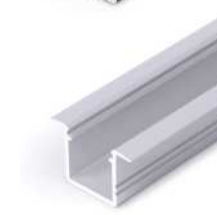

● raw aluminium  
surowe aluminium  
**E3020000**

max 10 mm

recessed  
wpustowy

Available lengths / Dostępne długości  
1000 mm, 2000 mm, 3000 mm, 4000 mm



## COVERS / KLOSZE

**A slide cover**  
colours: transparent, frosted, white  
material: PC, PP, PP

klosz **A** wsuwany  
kolory: przezroczysty, szron, mleczny  
materiał: PC, PP, PP



**Note!** Dimensions of the space to install LED source  
**Uwaga!** Wymiary przestrzeni do zamontowania źródła LED

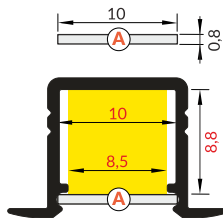

INDEX = 1 pc, length 2000 mm  
package = 10 pcs  
INDEKS = 1 szt., długość 2000 mm  
opakowanie = 10 szt.

**A transparent / A przezroczysty**  
89070016

**A frosted / A szron**  
89070039

**A white / A mleczny**  
89070038

## ENDINGS / ZAŚLEPKI

**SMART-IN10 ending with hole**  
colours: white, silver, black, grey  
material: ABS

zaślepka SMART-IN10 z otworem  
kolory: biały, srebrny, czarny, szary  
materiał: ABS

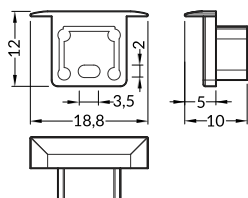

INDEX = 1 set  
package of 10 sets = 20 pcs  
INDEKS = 1 komplet, opakowanie  
zawiera 10 kompletów = 20 szt.

white biały E3990001

silver srebrne E3990040

black czarne E3990002

grey szare E3990022

## MOUNTINGS / MOCOWANIA

**Z flexible mounting plate**  
colours: white, inox, black  
material: stainless steel

uchwyt **Z** sprężysty  
kolory: biały, inox, czarny  
materiał: stal nierdzewna

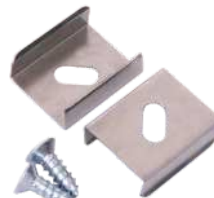
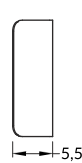
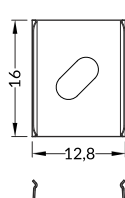
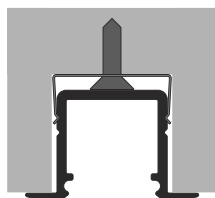

INDEX = 1 set  
package of 10 sets = 20 pcs  
INDEKS = 1 komplet  
opakowanie zawiera 10 kpl = 20 szt

**Z flexible mounting plate**  
uchwyt **Z** sprężysty

white biały 89270001

inox inox 89270019

black czarny 89270002

**cone Z flexible mounting plate**  
colours: white, inox, black  
material: stainless steel

uchwyt **Z** sprężysty cone  
kolory: biały, inox, czarny  
materiał: stal nierdzewna

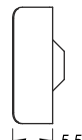
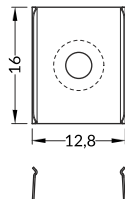
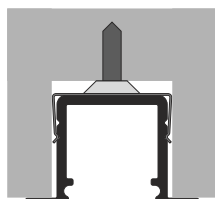

cone **Z** flexible mounting plate  
uchwyt **Z** sprężysty cone

white biały 89980001

inox inox 89980019

black czarny 89980002



# BEGTIN12 J/S



## SMALL RECESSED ALUMINIUM PROFILE

### MAŁY ALUMINIOWY PROFIL WPUSTOWY

- decorative and lighting profile
- light weight, budget profile
- used mainly in furniture
- Slick socket
- maximum LED strip width: 12 mm
- profil dekoracyjno-oświetleniowy
- lekki profil budżetowy
- głównie do zastosowania meblowego
- gniazdo z funkcją Slick
- maksymalna szerokość taśmy LED: 12 mm



## SIMILAR IN THE OFFER / PODOBNE W OFERCIE



DEEP10  
BC/UX



GROOVE10  
BC/UX



SMART-IN10  
A/Z



BEGTON12  
J/S



- J** slide cover  
klosz J wsuwany
- S<sup>1</sup>** flexible mounting plate  
uchwyt S sprężysty
- S<sup>2</sup>** cone S flexible mounting plate  
uchwyt S sprężysty cone

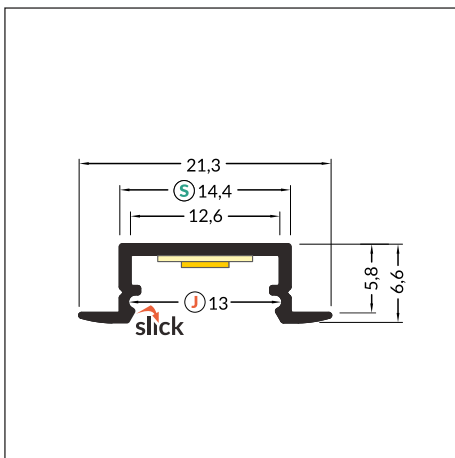
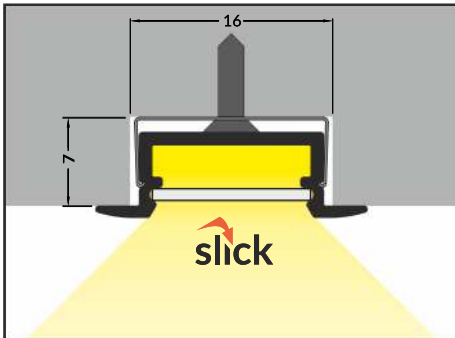
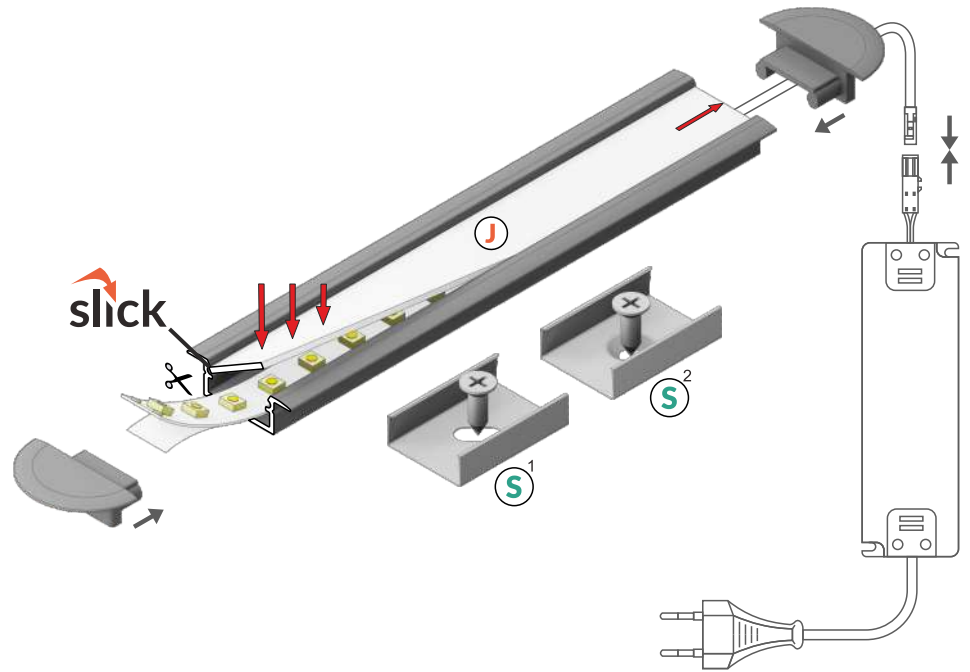

INDEX = 1 pc, length 2000 mm  
package = 10 pcs  
INDEKS = 1 szt., długość 2000 mm  
opakowanie = 10 szt.

 white painted  
biały malowany  
C8020001

 anodized  
anodowany  
C8020020

 black anodized  
czarny anodowany  
C8020021

 raw aluminium  
surowe aluminium  
C8020000

 max 12 mm

 recessed  
wpustowy

Available lengths / Dostępne długości  
1000 mm, 2000 mm, 3000 mm, 4000 mm



## COVERS / KLOSZE

### J slide cover

colours: transparent, frosted, white  
material: PC, PP, PP

klosz J wsuwany  
kolory: transparentny, szron, mleczny  
materiał: PC, PP, PP



**Note!** Dimensions of the space to install LED source  
**Uwaga!** Wymiary przestrzeni do zamontowania źródła LED

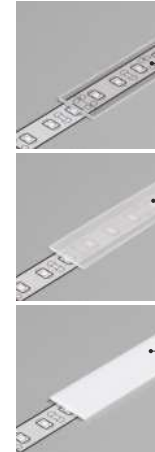
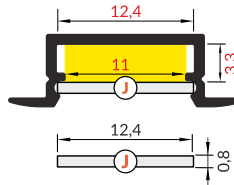

INDEX = 1 pc, length 2000 mm  
package = 10 pcs  
INDEKS = 1 szt., długość 2000 mm  
opakowanie = 10 szt.

J transparent / J transparentny  
70330016

J frosted / J szron  
70330039

J white / J mleczny  
70330038

## ENDINGS / ZAŚLEPKI

BEGTIN12 ending with hole  
colours: white, silver, black, grey  
material: ABS

zaślepka BEGTIN12 z otworem  
kolory: biały, srebrny, czarny, szary  
materiał: ABS

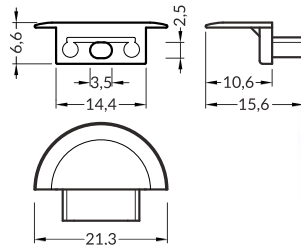

INDEX = 1 set  
package of 10 sets = 20 pcs  
INDEKS = 1 komplet, opakowanie  
zawiera 10 kompletów = 20 szt.

white  
białe C8980001

silver  
srebrne C8980040

black  
czarne C8980002

grey  
szare C8980022

## MOUNTINGS / MOCOWANIA

S flexible mounting plate  
colours: white, inox, black  
material: stainless steel

uchwyt S sprężysty  
kolory: biały, inox, czarny  
materiał: stal nierdzewna

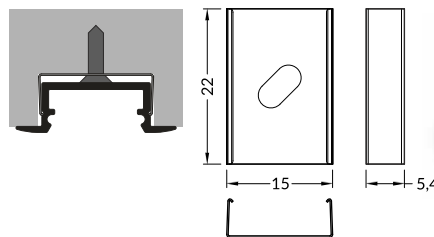

INDEX = 1 set  
package of 10 sets = 20 pcs  
INDEKS = 1 komplet, opakowanie  
zawiera 10 kompletów = 20 szt.

white  
biały C7980001

inox  
inox C7980019

black  
czarny C7980002

cone S flexible mounting plate  
colours: white, inox, black  
material: stainless steel

uchwyt S sprężysty cone  
kolory: biały, inox, czarny  
materiał: stal nierdzewna

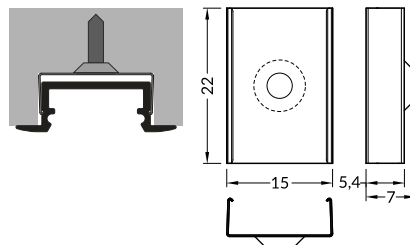

white  
biały C7950001

inox  
inox C7950019

black  
czarny C7950002



# FLOOR12 K/U

## RECESSED FLOOR PROFILE

### PROFIL WPUSTOWY DO PODŁÓG

- decorative and lighting profile
- high abrasion resistance, resistant cover
- possibility of waterproof
- with high humidity, please use waterproof tape
- maximum LED strip width: 12 mm
- profil dekoracyjno-oświetleniowy
- wysoka odporność na ścieranie, wytrzymały klosz
- możliwość uzyskania wodoszczelności
- przy podwyższonej wilgotności stosować taśmę wodoodporną
- maksymalna szerokość taśmy LED: 12 mm



## SIMILAR IN THE OFFER / PODOBNE W OFERCIE



STEP10  
C



OUTSTAIRS12  
BC



DEEP10  
BC/UX



UNI12  
BCD/U





**K**

**K click cover**  
klosz K klik

**U<sup>1</sup>**

**U flexible mounting plate**  
uchwyt U sprężysty

**U<sup>2</sup>**

**cone U flexible mounting plate**  
uchwyt U sprężysty cone

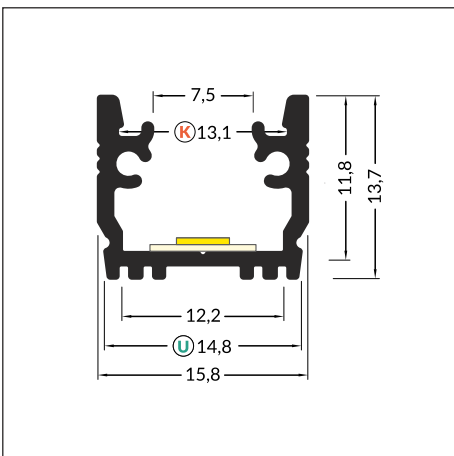
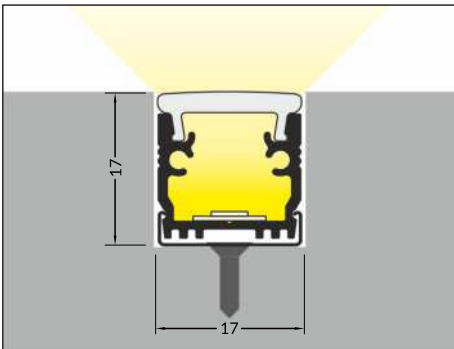
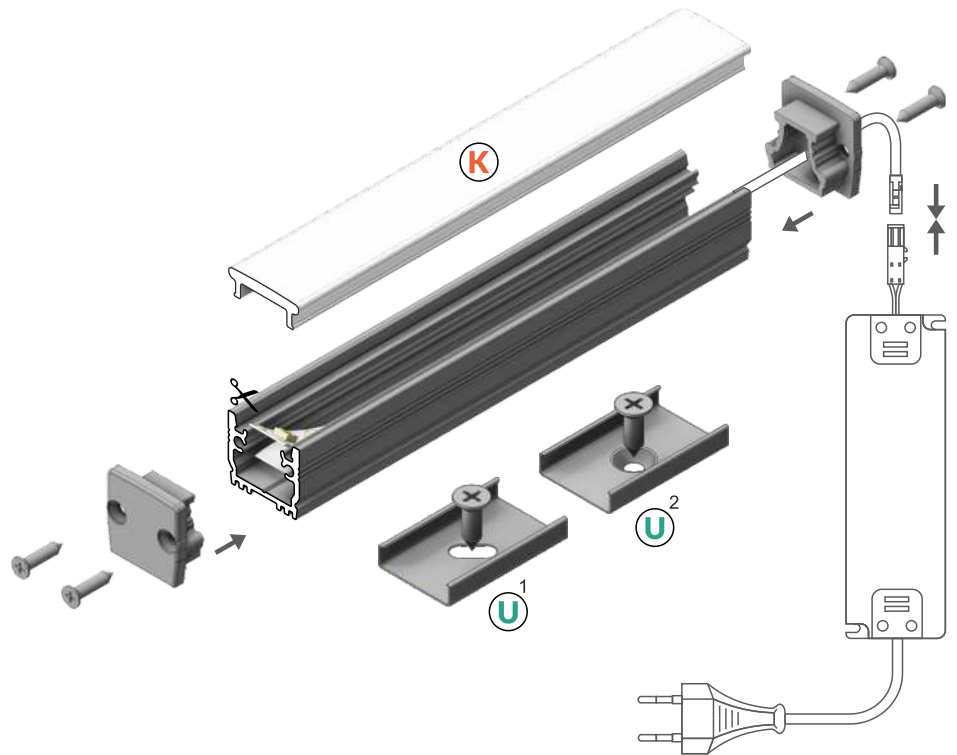

max 12 mm



recessed  
wpustowy



IK08 (5 J)



↓ 5 J

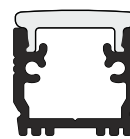

INDEX = 1 pc, length 2000 mm  
package = 10 pcs  
INDEKS = 1 szt., długość 2000 mm  
opakowanie = 10 szt.



anodized  
anodowany  
**B1020020**

Available lengths / Dostępne długości  
1000 mm, 2000 mm, 3000 mm, 4000 mm



## COVERS / KLOSZE

**K click cover**  
colour: white  
material: PC

klosz **K** klik  
kolor: mleczny  
materiał: PC

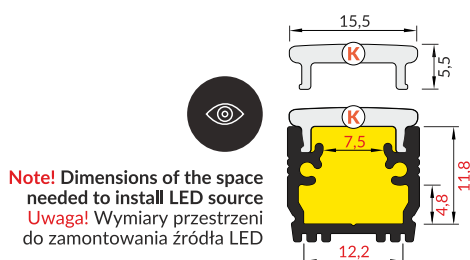

INDEX = 1 pc, length 2000 mm  
package = 10 pcs  
INDEKS = 1 szt., długość 2000 mm  
opakowanie = 10 szt.

**K white / K mleczny**  
**B1040038**

## ENDINGS / ZAŚLEPKI

**FLOOR12 ending**  
colours: silver, grey  
material: ABS

zaślepka FLOOR12  
kolory: srebrny, szary  
materiał: ABS

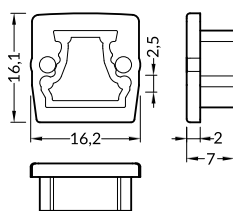

**FLOOR12 ending with hole**  
colours: silver, grey  
material: ABS

zaślepka FLOOR12 z otworem  
kolory: srebrny, szary  
materiał: ABS

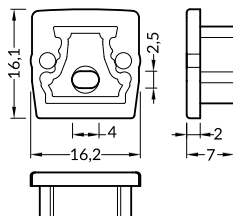

INDEX = 1 set  
package of 10 sets = 20 pcs  
INDEKS = 1 komplet, opakowanie  
zawiera 10 kompletów = 20 szt.

● silver  
srebrne

with hole  
z otworem  
**B1960040**

without hole  
bez otworu  
**B1940040**

● grey  
szare

with hole  
z otworem  
**B1960022**

without hole  
bez otworu  
**B1940022**

## MOUNTINGS / MOCOWANIA

**U flexible mounting plate**  
colour: inox  
material: stainless steel

uchwyt **U** sprężysty  
kolor: inox  
materiał: stal nierdzewna

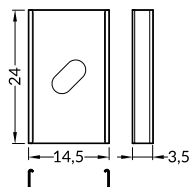
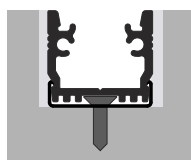

INDEX = 1 set  
package of 10 sets = 20 pcs  
INDEKS = 1 komplet  
opakowanie zawiera 10 kpl = 20 szt

**U flexible mounting plate**  
uchwyt **U** sprężysty

● inox  
inox  
**76380000**

**cone U flexible mounting plate**  
colour: inox  
material: stainless steel

uchwyt **U** sprężysty cone  
kolor: inox  
materiał: stal nierdzewna

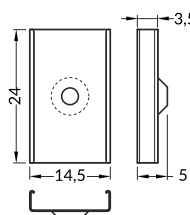
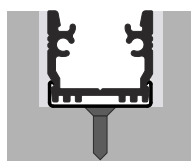

cone **U** flexible mounting plate  
uchwyt **U** sprężysty cone

● inox  
inox  
**76620000**

## SEALING / USZCZELKA

sealings for FLOOR12 endings  
2x silicone sealings  
4x rubber o-ring

uszczelki do zaślepki FLOOR12  
2x silikonowa uszczelka  
4x gumowa uszczelka o-ring



**In high humidity conditions**  
use waterproof tape and silicone seal  
Przy podwyższonej wilgotności zaleca się  
użycie zestawu uszczelniającego  
i wodoodpornej taśmy.



INDEX = 1 set  
INDEKS = 1 komplet

sealing set  
zestaw uszczelniający  
**B1830000**



# GROOVE14 EF/TY

## BASIC ALUMINIUM RECESSED PROFILE

### PODSTAWOWY, ALUMINIOWY PROFIL WPUSTOWY

- decorative and lighting profile
- used mainly in furniture
- maximum LED strip width: 14 mm
- profil dekoracyjno-oświetleniowy
- głównie do zastosowania meblowego
- maksymalna szerokość taśmy LED: 14 mm



## SIMILAR IN THE OFFER / PODOBNE W OFERCIE





**E** **E** slide cover  
klosz **E** wsuwany

**F** **F** click cover  
klosz **F** klik

**E7** **E7** click cover  
klosz **E7** klik

**Y**<sup>1</sup> **Y** flexible mounting plate  
uchwyt **Y** sprężysty

**Y**<sup>2</sup> **cone Y** flexible mounting plate  
uchwyt **Y** sprężysty cone

**T** **T** mounting plate  
uchwyt **T**

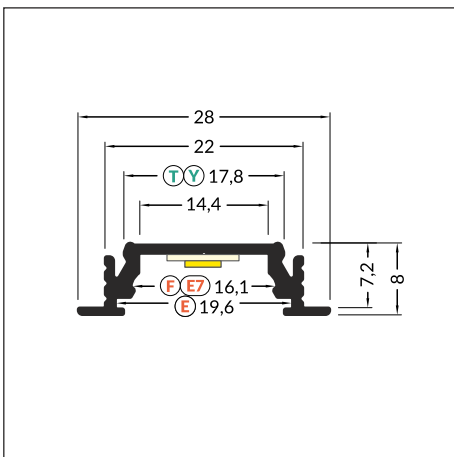
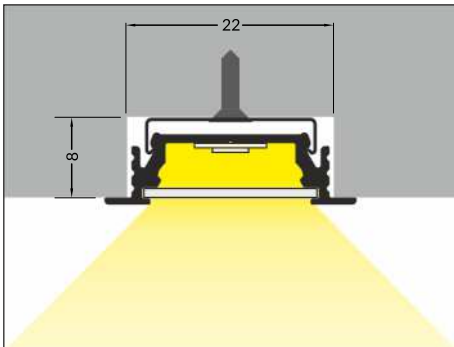
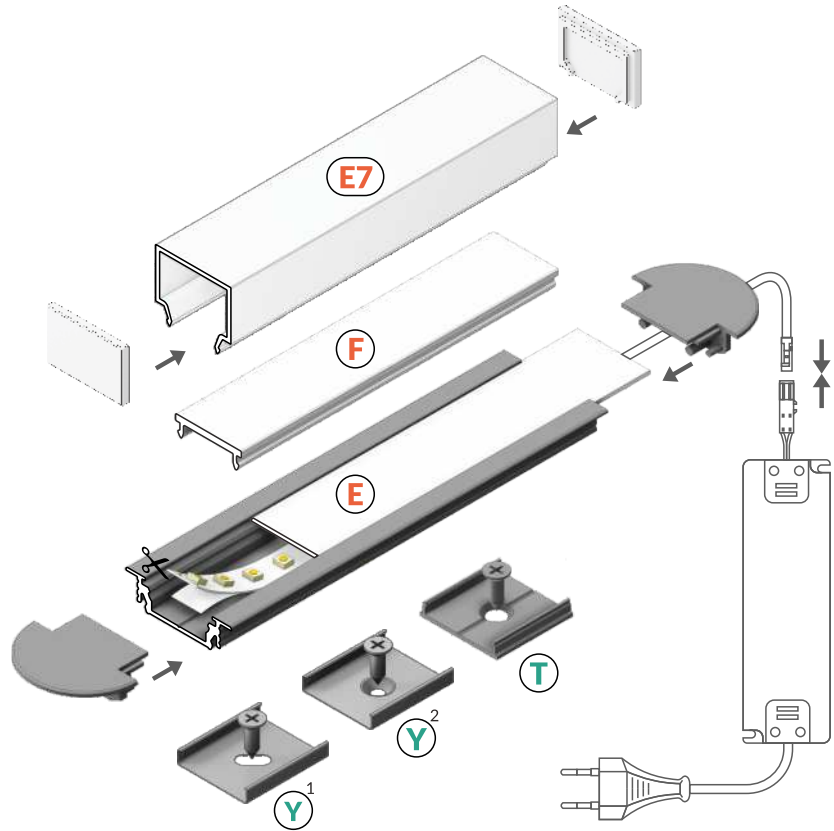

white painted  
biały malowany  
A3020001



anodized  
anodowany  
A3020020



black anodized  
czarny anodowany  
A3020021



raw aluminium  
surowe aluminium  
A3020000

 max 14 mm

 recessed  
wpustowy

Available lengths / Dostępne długości  
1000 mm, 2000 mm, 3000 mm, 4000 mm



## COVERS / KLOSZE

**E slide cover**  
colours: transparent, frosted, white  
material: PC, PP, PP

klosz E wsuwany  
kolory: transparentny, szron, mleczny  
materiał: PC, PP, PP



**Note!** Dimensions of the space to install LED source  
**Uwaga!** Wymiary przestrzeni do zamontowania źródła LED

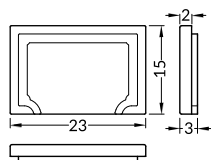
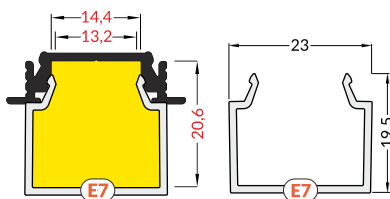
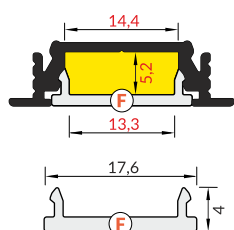
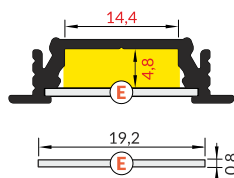

**F click cover**  
colours: transparent, white  
material: PMMA

klosz F klik  
kolory: transparentny, mleczny  
materiał: PMMA

**E7 click cover**  
colour: white  
material: PMMA

klosz E7 klik  
kolor: mleczny  
materiał: PMMA

INDEX = 1 pc, length 2000 mm  
package = 10 pcs  
INDEKS = 1 szt., długość 2000 mm  
opakowanie = 10 szt.

E transparent / E transparentny  
A2040016

E frosted / E szron  
A2040039

E white / E mleczny  
A2040038

F transparent / F transparentny  
A2060016

F white / F mleczny  
A2060038

E7 white / E7 mleczny  
C1080038

INDEX = 1 set  
package of 10 sets = 20 pcs  
INDEKS = 1 komplet, opakowanie  
zawiera 10 kompletów = 20 szt.

E7 white ending  
zaślepka E7 mleczny  
C1840038

## MOUNTINGS / MOCOWANIA

**Y flexible mounting plate**  
colour: inox  
material: stainless steel

uchwyt Y sprężysty  
kolor: inox  
materiał: stal nierdzewna

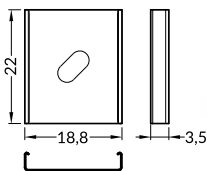
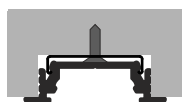

**cone Y flexible mounting plate**  
colour: inox  
material: stainless steel

uchwyt Y sprężysty cone  
kolor: inox  
materiał: stal nierdzewna

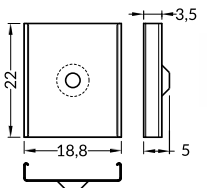

**T mounting plate**  
colour: raw aluminium  
material: aluminium

uchwyt T  
kolor: surowe aluminium  
materiał: aluminium

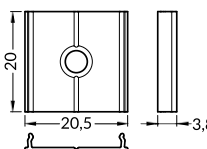

INDEX = 1 set  
package of 10 sets = 20 pcs  
INDEKS = 1 komplet, opakowanie  
zawiera 10 kompletów = 20 szt.

Y flexible mounting plate  
uchwyt Y sprężysty

inox  
inox A2090019

cone Y flexible mounting plate  
uchwyt Y sprężysty cone

inox  
inox A2130019

T mounting plate  
uchwyt T

raw aluminium  
surowe aluminium  
C6960000





## ENDINGS / ZAŚLEPKI

**GROOVE14 ending with hole**  
colours: white, silver, black, grey  
material: ABS

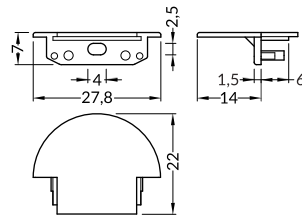
zaślepka GROOVE14 z otworem  
kolory: biały, srebrny, czarny, szary  
materiał: ABS



INDEX = 1 set  
package of 10 sets = 20 pcs  
INDEKS = 1 komplet, opakowanie  
zawiera 10 kompletów = 20 szt.

-  white  
białe **A3100001**
-  silver  
srebrne **A3100040**
-  black  
czarne **A3100002**
-  grey  
szare **A3100022**

## CONNECTORS / ŁĄCZNIKI

**T connector**  
colour: raw aluminium  
material: aluminium

łącznik T  
kolor: surowe aluminium  
materiał: aluminium

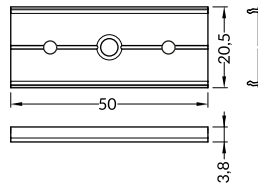

INDEX = 1 set  
INDEKS = 1 komplet

T connector / łącznik T



-  raw aluminium  
surowe aluminium  
**C6990000**

connector 90 deg / łącznik 90 st

**GROOVE14 connector 90 deg**  
colours: white, anodized, black  
material: aluminium

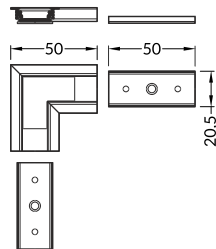
łącznik GROOVE14 90 st  
kolory: biały, anodowany, czarny  
materiał: aluminium



-  white painted  
biały malowany  
**A3990001**
-  anodized  
anodowany  
**A3990020**
-  black anodized  
czarny anodowany  
**A3990021**



# LINEA-IN20 EF/U7

## CREATING LIGHTING PATTERNS THANKS TO ANGULAR CONNECTORS

### KSZTAŁTOWANIE WZORÓW ŚWIETLNYCH DZIĘKI ŁĄCZNIKOM KĄTOWYM

- recessed, lighting profile - dedicated to medium-voltage light sources
  - continuous line of light (when using LED strip 120 P/m and white cover)
  - angled connections illuminated
  - 20 accessories available
  - 3 mounting options of LED modules: thermic tape, LED module on a strip, additionally LED clamp
  - maximum LED source width: 20 mm
- wpustowy profil oświetleniowy - przeznaczony do źródeł światła o średniej mocy
  - ciągła linia światła (przy użyciu taśm 120 P/m oraz klosza mlecznego)
  - świecące połączenia kątowe
  - 20 akcesoriów
  - 3 sposoby mocowania modułów LED: taśmą termiczną, moduł na taśmie, dodatkowo docisk LED
  - maksymalna szerokość źródła LED: 20 mm

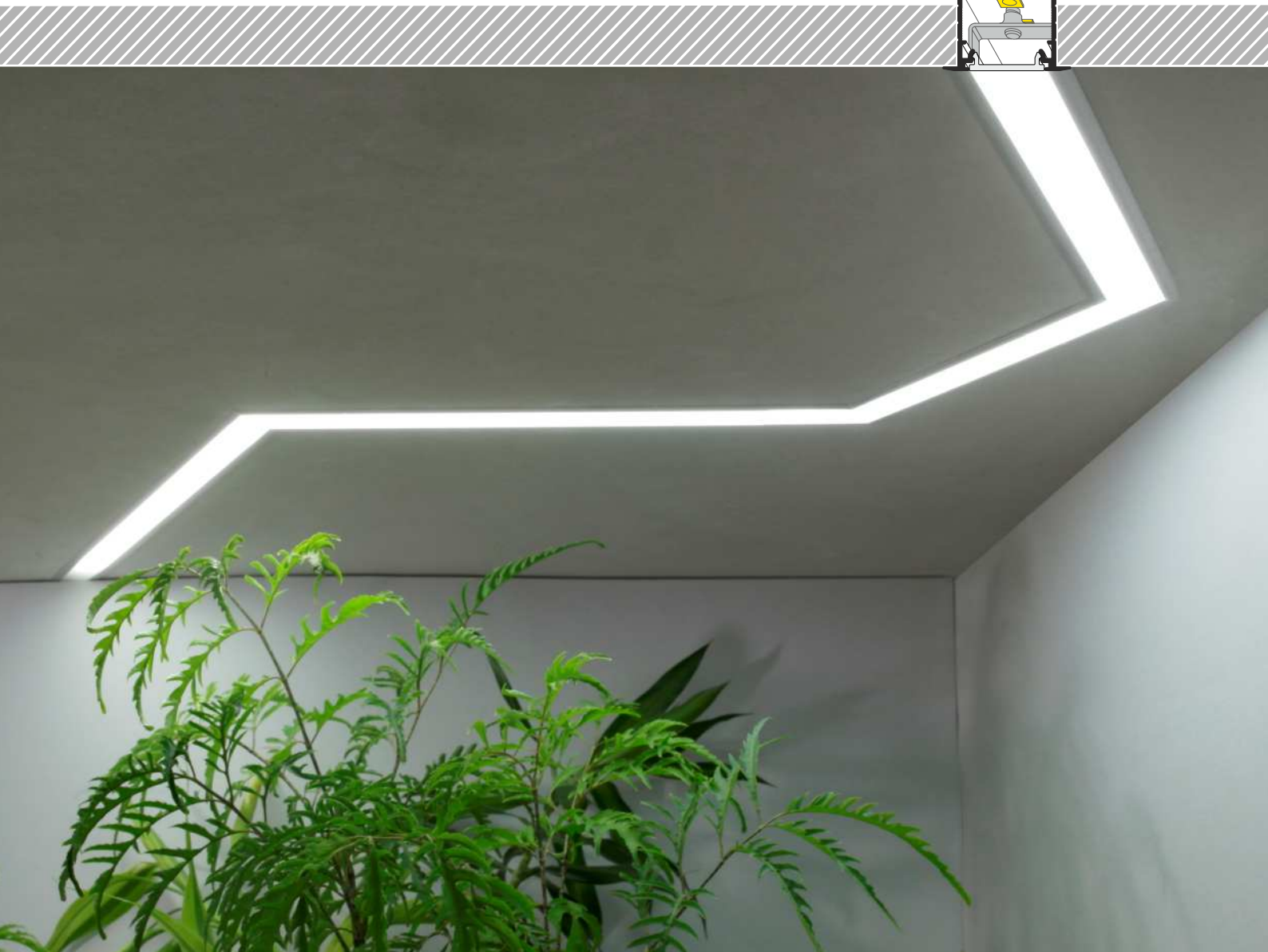
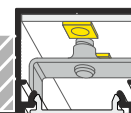

## SIMILAR IN THE OFFER / PODOBNE W OFERCIE







- E** slide cover  
klosz E wsuwany
- F** click cover  
klosz F klik
- E7** E7 click cover  
klosz E7 klik
- U7**<sup>1</sup> U7 mounting plate  
uchwyt U7
- U7**<sup>2</sup> cone U7 mounting plate  
uchwyt U7 cone
- U7**<sup>3</sup> rack U7 mounting plate  
uchwyt U7 rack
- U7**<sup>4</sup> spring U7 mounting plate  
uchwyt U7 sprężyna

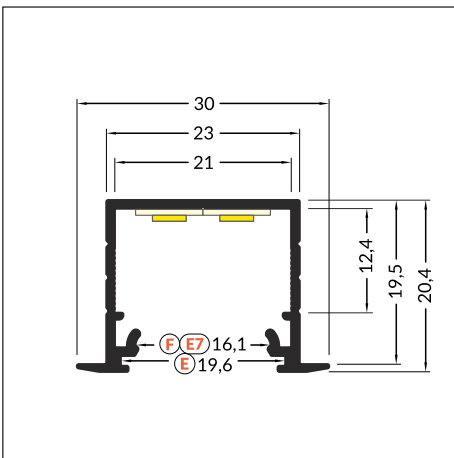
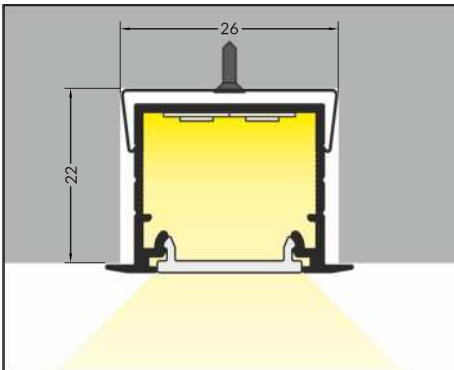
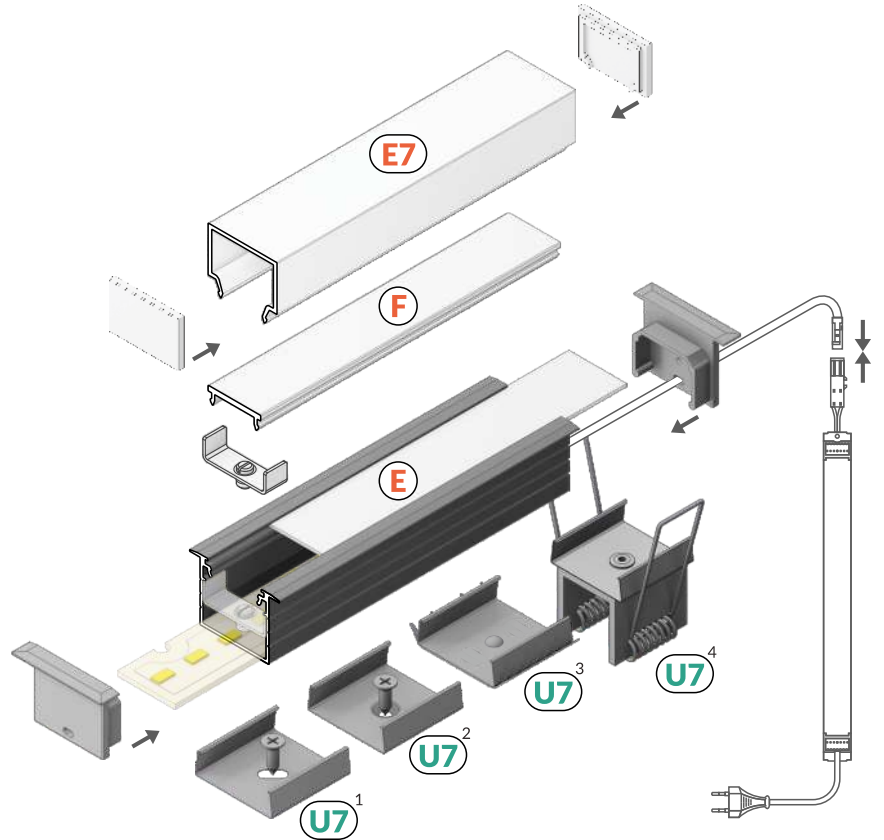

○ white painted  
biały malowany  
E4020001

● anodized  
anodowany  
E4020020

● black anodized  
czarny anodowany  
E4020021

○ raw aluminium  
surowe aluminium  
E4020000

○ max 20 mm

○ recessed  
wpustowy

Available lengths / Dostępne długości  
1000 mm, 2000 mm, 3000 mm, 4000 mm



## COVERS / KLOSZE

**E slide cover**  
colours: transparent, frosted, white  
material: PC, PP, PP

klosz **E** wsuwany  
kolory: transparentny, szron, mleczny  
materiał: PC, PP, PP



**Note!** Dimensions of the space to install LED source  
**Uwaga!** Wymiary przestrzeni do zamontowania źródła LED

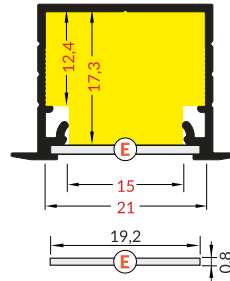

INDEX = 1 pc, length 2000 mm  
package = 10 pcs  
INDEKS = 1 szt., długość 2000 mm  
opakowanie = 10 szt.

**E transparent / E transparentny**  
A2040016



**E frosted / E szron**  
A2040039

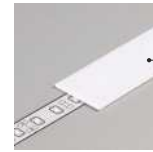

**E white / E mleczny**  
A2040038



**F transparent / F transparentny**  
A2060016

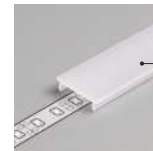

**F white / F mleczny**  
A2060038

**F click cover**  
colours: transparent, white  
material: PMMA

klosz **F** klik  
kolory: transparentny, mleczny  
materiał: PMMA

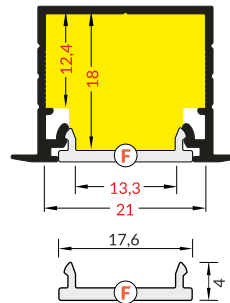

**E7 click cover**  
colour: white  
material: PMMA

klosz **E7** klik  
kolor: mleczny  
materiał: PMMA

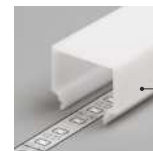
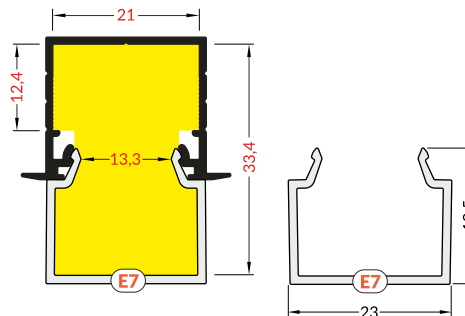

**E7 white / E7 mleczny**  
C1080038

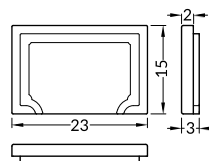

INDEX = 1 set  
package of 10 sets = 20 pcs  
INDEKS = 1 komplet, opakowanie  
zawiera 10 kompletów = 20 szt.

**E7 white ending**  
zaślepka **E7** mleczny  
C1840038

## ENDINGS / ZAŚLEPKI

**LINEA-IN20 ending with hole**  
colours: white, silver, black, grey  
material: ABS

zaślepka LINEA-IN20 z otworem  
kolory: biały, srebrny, czarny, szary  
materiał: ABS

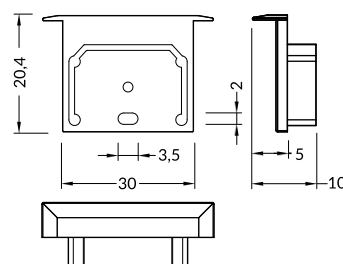

INDEX = 1 set  
package of 10 sets = 20 pcs  
INDEKS = 1 komplet, opakowanie  
zawiera 10 kompletów = 20 szt.

-  white biały E4990001
-  silver srebrne E4990040
-  black czarny E4990002
-  grey szare E4990022



## MOUNTINGS / MOCOWANIA

**U7 mounting plate**  
colour: inox  
material: stainless steel

uchwyt **U7**  
kolor: inox  
materiał: stal nierdzewna

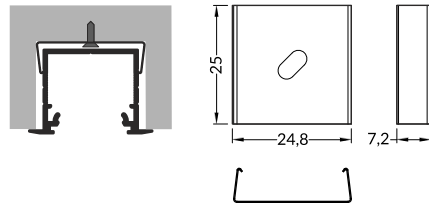

INDEX = 1 set  
package of 10 sets = 20 pcs  
INDEKS = 1 komplet, opakowanie  
zawiera 10 kompletów = 20 szt.

**U7 mounting plate**  
uchwyt **U7**

 inox  
E4960019

**cone U7 mounting plate**  
colour: inox  
material: stainless steel

uchwyt **U7** cone  
kolor: inox  
materiał: stal nierdzewna

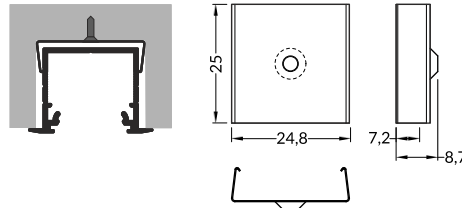

cone **U7** mounting plate  
uchwyt **U7** cone

 inox  
E4970019

**rack U7 mounting plate**  
colour: inox  
material: stainless steel

uchwyt **U7** rack  
kolor: inox  
materiał: stal nierdzewna

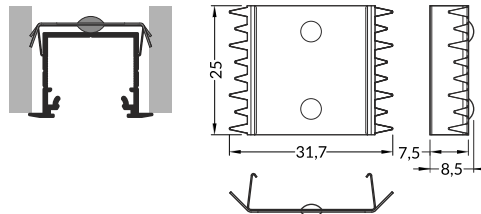

rack **U7** mounting plate  
uchwyt **U7** rack

 inox  
E4980019

**spring U7 mounting plate**  
colour: inox  
material: stainless steel

uchwyt **U7** sprężyna  
kolor: inox  
materiał: stal nierdzewna

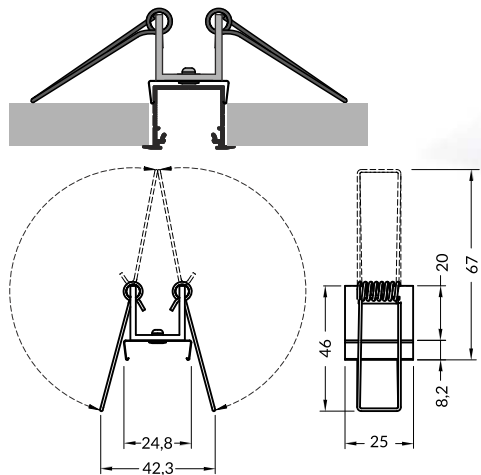

INDEX = 2 pcs  
INDEKS = 2 szt.

spring **U7** mounting plate  
uchwyt **U7** sprężyna

 inox  
E4880019s

## CLAMP / DOCISK

**LINEA20 LED clamp**  
colour: white  
material: painted steel, plastic

docisk LED LINEA20  
kolor: biały  
materiał: stal malowana,  
tworzywo

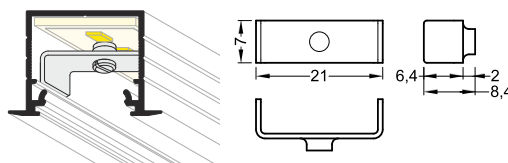

INDEX = 1 set  
package of 10 sets = 20 pcs  
INDEKS = 1 komplet, opakowanie  
zawiera 10 kompletów = 20 szt.

 white  
biały  
C6940001

# LINEA-IN20 EF/U7

## CONNECTION POSSIBILITY MOŻLIWOŚCI ŁĄCZENIA



60°



90°



120°



135°



180°

### ANGULAR CONNECTORS

Thanks to five different angle connectors (60° / 90° / 120° / 135° / 180°) it is possible to create many various lighting systems – with no need to cut the profile at an angle.

Bent connectors allows to connect profiles in two planes, at two angles: 90° on the inside and 270° on the outside.

### ŁĄCZNIKI KĄTOWE

Dzięki łącznikom o pięciu różnych kątach (60° / 90° / 120° / 135° / 180°) możliwe jest tworzenie wielu różnych układów oświetlenia bez konieczności cięcia profilu pod skosem.

Łączniki gięte umożliwiają łączenie profili w dwóch płaszczyznach, pod dwoma kątami: wewnętrznym 90° i zewnętrznym 270°.

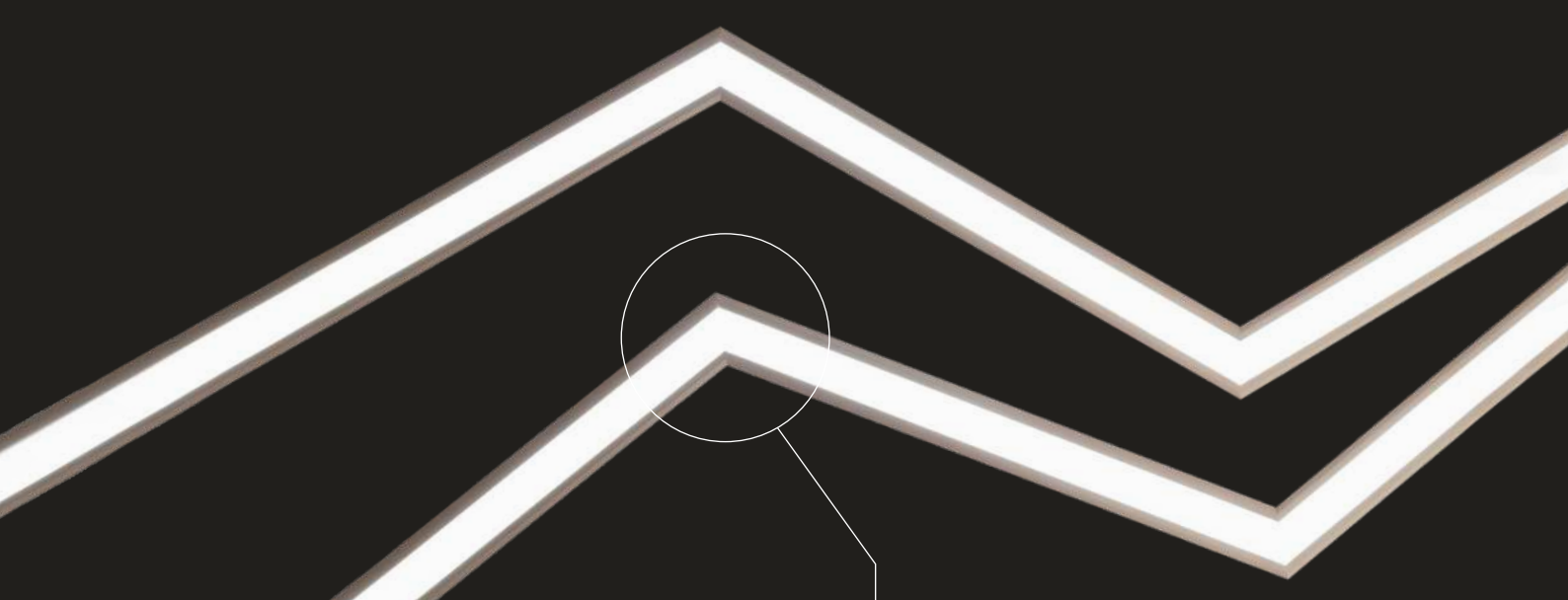

The component made of clear fabric provides secure connection, letting light through at the same time. Thanks to that, the luminaire can illuminate on the entire surface of the cover – even in the corners.

Element z przezroczystego tworzywa zapewnia stabilizację łączenia, jednocześnie przepuszczając światło. Dzięki temu oprawa może świecić na całej powierzchni klosza - również w rogach.



## CONNECTORS / ŁĄCZNIKI

**LINEA-IN20 connector 60 deg**  
colours: white, anodized, black  
material: aluminium, polycarbonate



łącznik LINEA-IN20 60 st  
kolory: biały, anodowany, czarny  
materiał: aluminium, poliwęglan

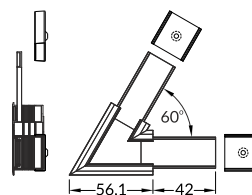

INDEX = 1 set  
INDEKS = 1 zestaw

connector 60 deg  
łącznik 60 st

- white biały E4890001s
- anodized anodowany E4890020s
- black czarny E4890021s

**LINEA-IN20 connector 90 deg**  
colours: white, anodized, black  
material: aluminium, polycarbonate

łącznik LINEA-IN20 90 st  
kolory: biały, anodowany, czarny  
materiał: aluminium, poliwęglan

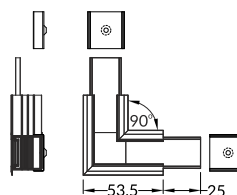

connector 90 deg  
łącznik 90 st

- white biały E4900001s
- anodized anodowany E4900020s
- black czarny E4900021s

**LINEA-IN20 connector 90 deg bent**  
colours: white, anodized, black  
material: aluminium, polycarbonate



łącznik LINEA-IN20 90 st gięty  
kolory: biały, anodowany, czarny  
materiał: aluminium, poliwęglan

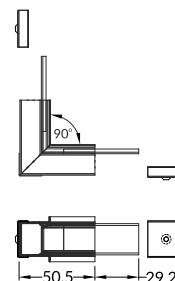

connector 90 deg bent  
łącznik 90 st gięty

- white biały E4910001s
- anodized anodowany E4910020s
- black czarny E4910021s

**LINEA-IN20 connector 120 deg**  
colours: white, anodized, black  
material: aluminium, polycarbonate



łącznik LINEA-IN20 120 st  
kolory: biały, anodowany, czarny  
materiał: aluminium, poliwęglan

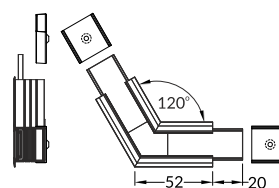

connector 120 deg  
łącznik 120 st

- white biały E4920001s
- anodized anodowany E4920020s
- black czarny E4920021s

**LINEA-IN20 connector 135 deg**  
colours: white, anodized, black  
material: aluminium, polycarbonate



łącznik LINEA-IN20 135 st  
kolory: biały, anodowany, czarny  
materiał: aluminium, poliwęglan

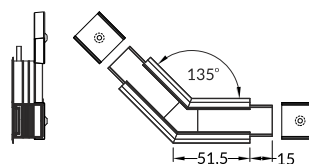

connector 135 deg  
łącznik 135 st

- white biały E4930001s
- anodized anodowany E4930020s
- black czarny E4930021s

**LINEA-IN20 connector 180 deg**  
material: polycarbonate

łącznik LINEA-IN20 180 st  
materiał: poliwęglan

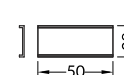

connector 180 deg  
łącznik 180 st

E4940000s

**LINEA-IN20 connector 270 deg bent**  
colours: white, anodized, black  
material: aluminium, polycarbonate



łącznik LINEA-IN20 270 st gięty  
kolory: biały, anodowany, czarny  
materiał: aluminium, poliwęglan

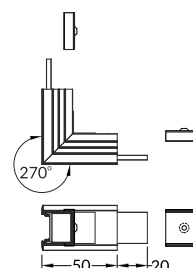

connector 270 deg bent  
łącznik 270 st gięty

- white biały E4950001s
- anodized anodowany E4950020s
- black czarny E4950021s

# LINEA-IN20 EF/U7

CONTINUOUS LIGHT OF LINE  
when using LED strip 120 P/m and white cover

CIĄGŁA LINIA ŚWIATŁA  
przy użyciu taśm 120 P/m oraz klosza mlecznego











**CORNER  
KATOWE**

# 2017

**LED profiles**  
**profile LED**

# TRIO10 BC

## ANGULAR PROFILE 45°

### PROFIL KĄTOWY 45°

- decorative and lighting profile
- for display cases' corners (mounted with screws)
- recessed (mounted with adhesive glue)
- suitable also for lighting up steps
- maximum LED strip width: 10 mm
- profil dekoracyjno-oświetleniowy
- do narożników gablot (montaż na wkręty)
- do wpuszczania (mocowanie na klej montażowy)
- nadaje się również do podświetlania stopni schodowych
- maksymalna szerokość taśmy LED: 10 mm

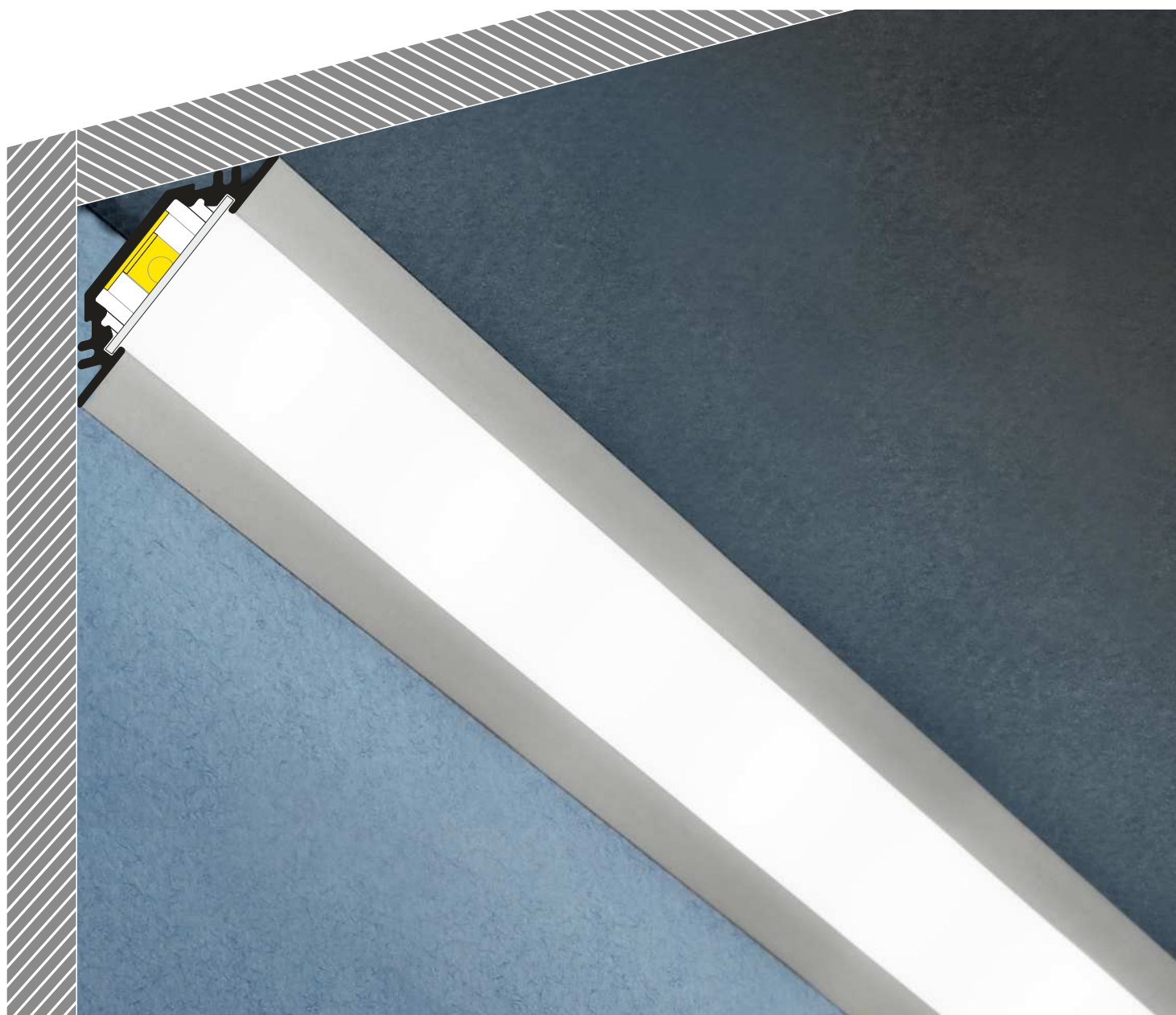

## SIMILAR IN THE OFFER / PODOBNE W OFERCIE





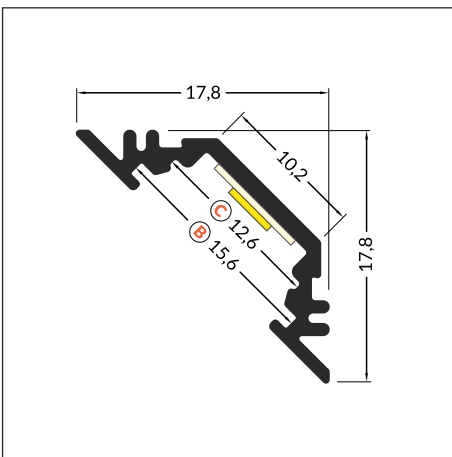
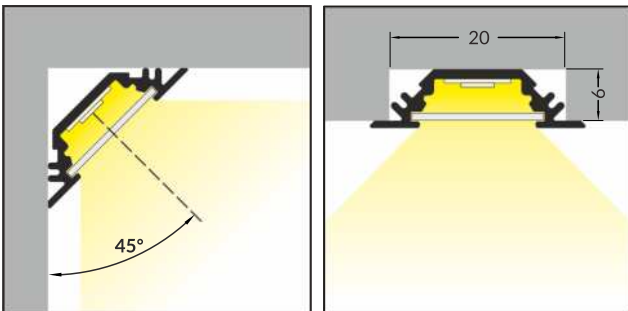
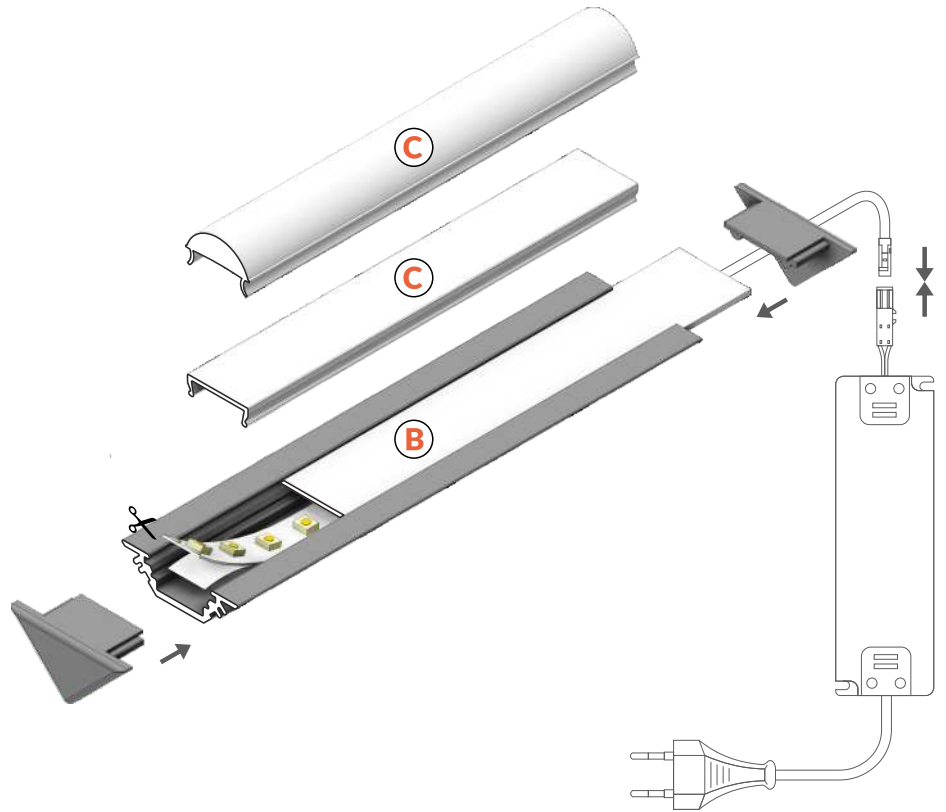

- B** slide cover  
klosz B wsuwany
- C** click cover  
klosz C klik
- C** lens cover  
klosz C soczewka



INDEX = 1 pc, length 2000 mm  
package = 10 pcs  
INDEKS = 1 szt., długość 2000 mm  
opakowanie = 10 szt.

 white painted  
biały malowany  
91030001

 anodized  
anodowany  
91030020

 black anodized  
czarny anodowany  
91030021

 raw aluminium  
surowe aluminium  
91030000

SOON

Available lengths / Dostępne długości  
1000 mm, 2000 mm, 3000 mm, 4000 mm



## COVERS / KLOSZE

**B slide cover**  
colours: transparent, frosted, white  
material: PC, PP, PP

klosz B wsuwany  
kolory: transparentny, szron, mleczny  
materiał: PC, PP, PP



**Note!** Dimensions of the space to install LED source  
**Uwaga!** Wymiary przestrzeni do zamontowania źródła LED

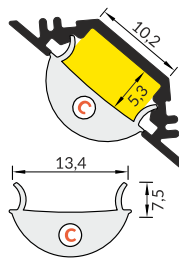
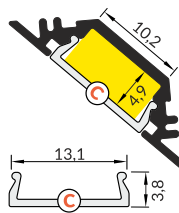
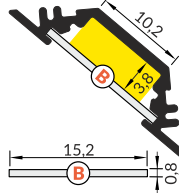

**C click cover**  
colours: transparent, white  
material: PMMA

klosz C klik  
kolory: transparentny, mleczny  
materiał: PMMA

**C lens click cover**  
colour: transparent  
material: PC

klosz C klik soczewka  
kolor: transparentny  
materiał: PC

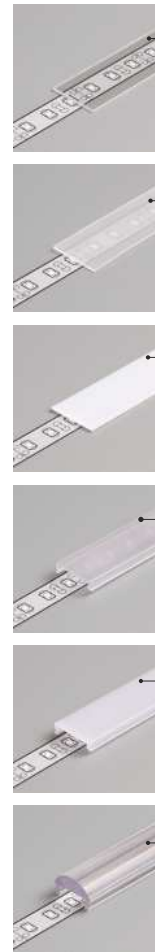

INDEX = 1 pc, length 2000 mm  
package = 10 pcs  
INDEKS = 1 szt., długość 2000 mm  
opakowanie = 10 szt.

**B transparent / B transparentny**  
76250016

**B frosted / B szron**  
76250039

**B white / B mleczny**  
76250038

**C transparent / C transparentny**  
76330000

**C white / C mleczny**  
76330038

**C lens / C soczewka**  
76300000

## ENDINGS / ZAŚLEPKI

**TRIO10 ending**  
colours: white, silver, black, grey  
material: ABS

zaślepka TRIO10  
kolory: biały, srebrny, czarny, szary  
materiał: ABS

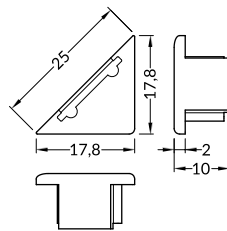

Ending with marked space to bore the holes.  
Zaślepka z punktami do przewiercenia otworów.

INDEX = 1 set,  
package of 10 sets = 20 pcs  
INDEKS = 1 komplet, opakowanie  
zawiera 10 kompletów = 20 szt.

white  
białe 91060001

silver  
srebrne 91060040

black  
czarne 91060002

grey  
szare 91060022

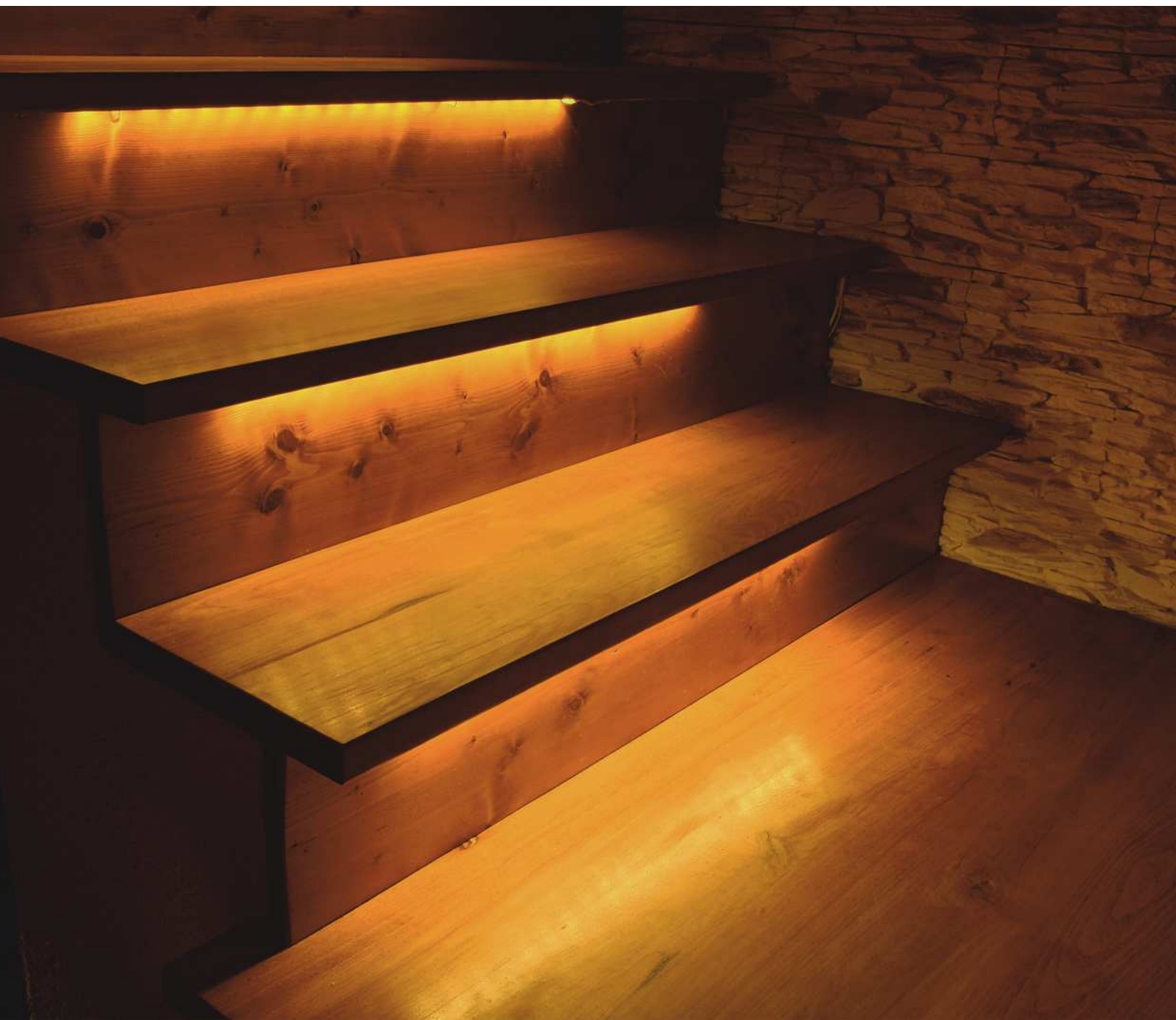

# CORNER10 BC/UX

## SMALL, ALUMINIUM, ANGULAR PROFILE

### MAŁY, ALUMINIOWY PROFIL KĄTOWY

- lighting directions: 30° or 60°
- hidden mounting
- decorative and lighting profile
- wide range of accessories, 6 types of covers
- maximum LED strip width: 10 mm

- dwa kąty świecenia: 30° i 60°
- ukryte mocowanie
- profil dekoracyjno-oświetleniowy
- szeroki wybór akcesoriów, 6 rodzajów kloszy
- maksymalna szerokość taśmy LED: 10 mm



## SIMILAR IN THE OFFER / PODOBNE W OFERCIE



TRIO10  
BC



QUARTER10  
BD/U6



CABI12  
E



CORNER14  
EF/TY



CORNER27  
G/UX



**B** B slide cover  
klosz B wsuwany

**C** C click cover  
klosz C klik

**C** C lens cover  
klosz C soczewka

**U**<sup>1</sup> U flexible mounting plate  
uchwyt U sprężysty

**U**<sup>2</sup> cone U flexible mounting plate  
uchwyt U sprężysty cone

**X**<sup>1</sup> X mounting plate  
uchwyt X

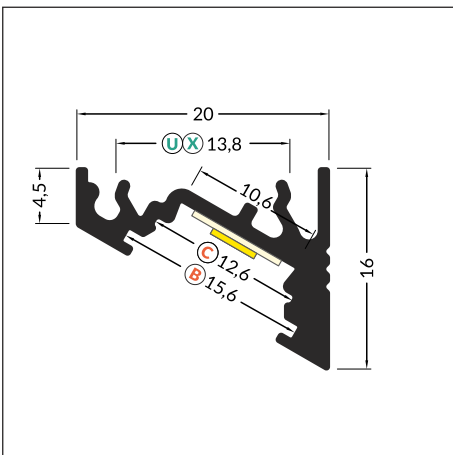
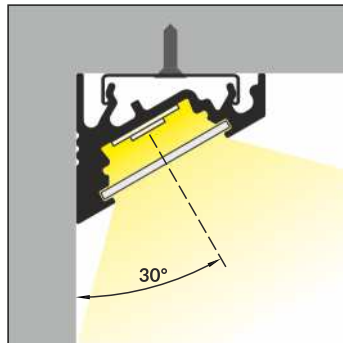
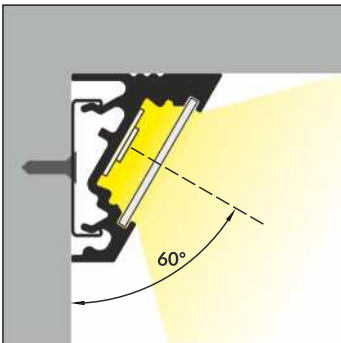
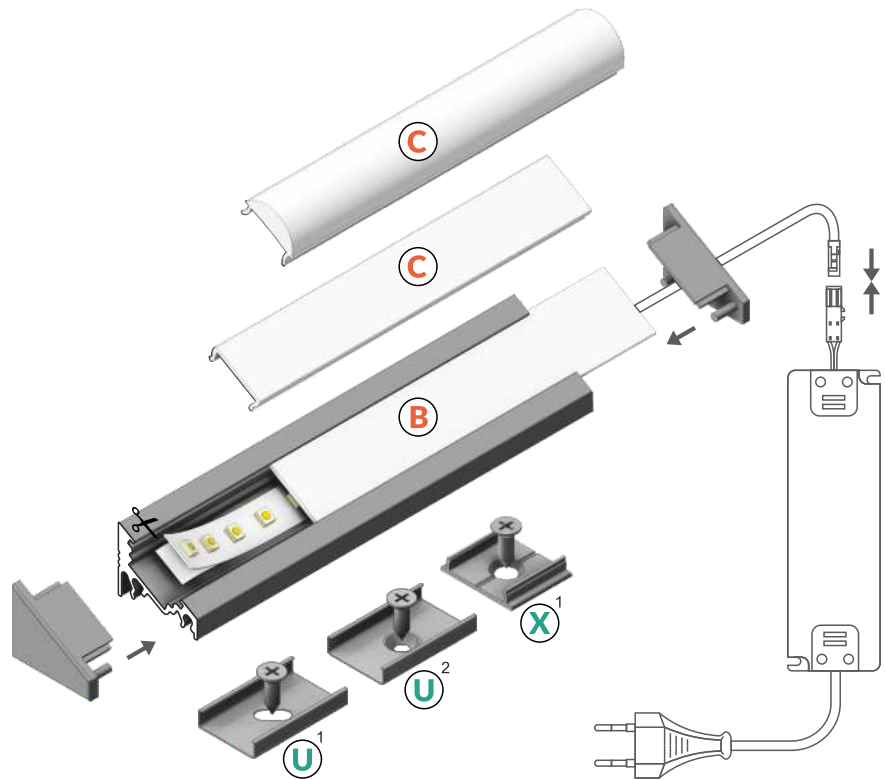

INDEX = 1 pc, length 2000 mm  
package = 10 pcs  
INDEKS = 1 szt., długość 2000 mm  
opakowanie = 10 szt.

 white painted  
biały malowany  
83050001

 anodized  
anodowany  
83050020

 black anodized  
czarny anodowany  
83050021

 raw aluminium  
surowe aluminium  
83050000

Available lengths / Dostępne długości  
1000 mm, 2000 mm, 3000 mm, 4000 mm



## COVERS / KLOSZE



### B slide cover

colours: transparent, frosted, white  
material: PC, PP, PP

klosz B wsuwany  
kolory: transparentny, szron, mleczny  
materiał: PC, PP, PP

**Note!** Dimensions of the space to install LED source  
**Uwaga!** Wymiary przestrzeni do zamontowania źródła LED

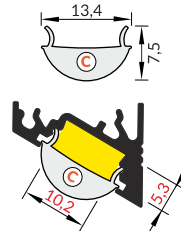
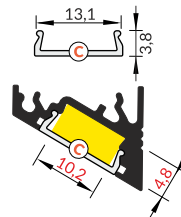
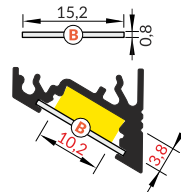

### C click cover

colours: transparent, white  
material: PMMA

klosz C klik  
kolory: transparentny, mleczny  
materiał: PMMA

### C click cover lens

colour: transparent  
material: PC

klosz C klik soczewka  
kolor: transparentny  
materiał: PC

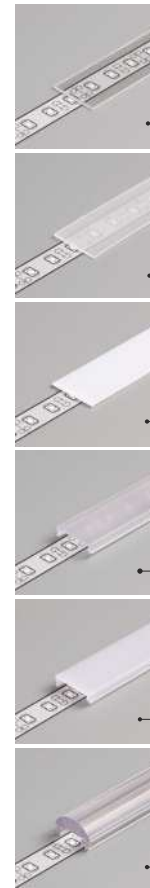

INDEX = 1 pc, length 2000 mm  
package = 10 pcs  
INDEKS = 1 szt., długość 2000 mm  
opakowanie = 10 szt.

B transparent / B transparentny  
76250016

B frosted / B szron  
76250039

B white / B mleczny  
76250038

C transparent / C transparentny  
76330000

C white / C mleczny  
76330038

C lens / C soczewka  
76300000

## ENDINGS / ZAŚLEPKI

### endings CORNER10

colours: white, silver, black, grey  
material: ABS

zaślepka CORNER10  
kolory: biały, srebrny, czarny, szary  
materiał: ABS

### endings CORNER10 with hole

colours: white, silver, black, grey  
material: ABS

zaślepka CORNER10 z otworem  
kolory: biały, srebrny, czarny, szary  
materiał: ABS

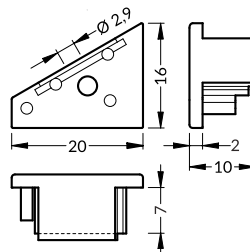

INDEX = 1 set  
package of 10 sets = 20 pcs  
INDEKS = 1 komplet, opakowanie zawiera 10 kompletów = 20 szt.

	white białe	with hole z otworem 83130001	without hole bez otworu 83150001
--	----------------	------------------------------------	--

	silver srebrne	with hole z otworem 83130040	without hole bez otworu 83150040
--	-------------------	------------------------------------	--

	black czarne	with hole z otworem 83130002	without hole bez otworu 83150002
--	-----------------	------------------------------------	--

	grey szare	with hole z otworem 83130022	without hole bez otworu 83150022
--	---------------	------------------------------------	--

## CONNECTORS / ŁĄCZNIKI

### X connector

colour: raw aluminium  
material: aluminium

łącznik X  
kolor: surowe aluminium  
materiał: aluminium

### CORNER10 L connector

colours: white, anodized, black  
material: aluminium

łącznik L CORNER10  
kolory: biały, anodowany, czarny  
materiał: aluminium

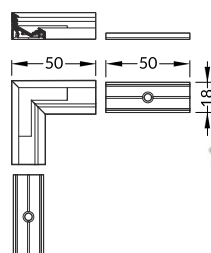
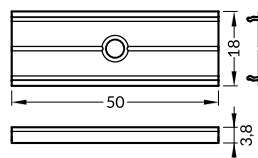

INDEX = 1 set  
INDEKS = 1 komplet

### X connector łącznik X

	raw aluminium surowe aluminium 76350000
--	---

### L connector / łącznik L

	white painted biały malowany	83110001
--	---------------------------------	----------

	anodized anodowany	83110020
--	-----------------------	----------

	black anodized czarny anodowany	83110021
--	------------------------------------	----------





## MOUNTINGS / MOCOWANIA

### U flexible mounting plate

colours: inox  
material: stainless steel

uchwyt U sprężysty  
kolory: inox  
materiał: stal nierdzewna

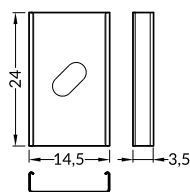
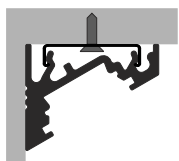

INDEX = 1 set  
package of 10 sets = 20 pcs  
INDEKS = 1 komplet  
opakowanie zawiera 10 kpl = 20 szt

U flexible mounting plate  
uchwyt U sprężysty

● inox 76380000

### cone U flexible mounting plate

colours: inox  
material: stainless steel

uchwyt U sprężysty cone  
kolory: inox  
materiał: stal nierdzewna

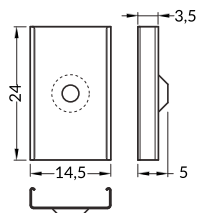
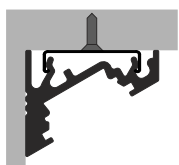

cone U flexible mounting plate  
uchwyt U sprężysty cone

● inox 76620000

### X mounting plate

colours: raw aluminium  
material: aluminium

uchwyt X  
kolory: surowe aluminium  
materiał: aluminium

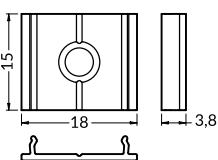
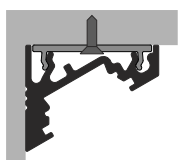

X mounting plate  
uchwyt X

● raw aluminium  
surowe aluminium  
76260000



# QUARTER10 BD/U6

## LIGHT FROM AN ANGLE

### ŚWIATŁO Z NAROŻNIKA

- full circle quadrant illumination
- LED strip aligned to 45° angle
- Slick socket
- maximum LED strip width: 10 mm
- pełne oświetlenie ćwiartki koła
- taśma ustawiona pod kątem 45 stopni
- gniazdo Slick
- maksymalna szerokość taśmy LED: 10 mm

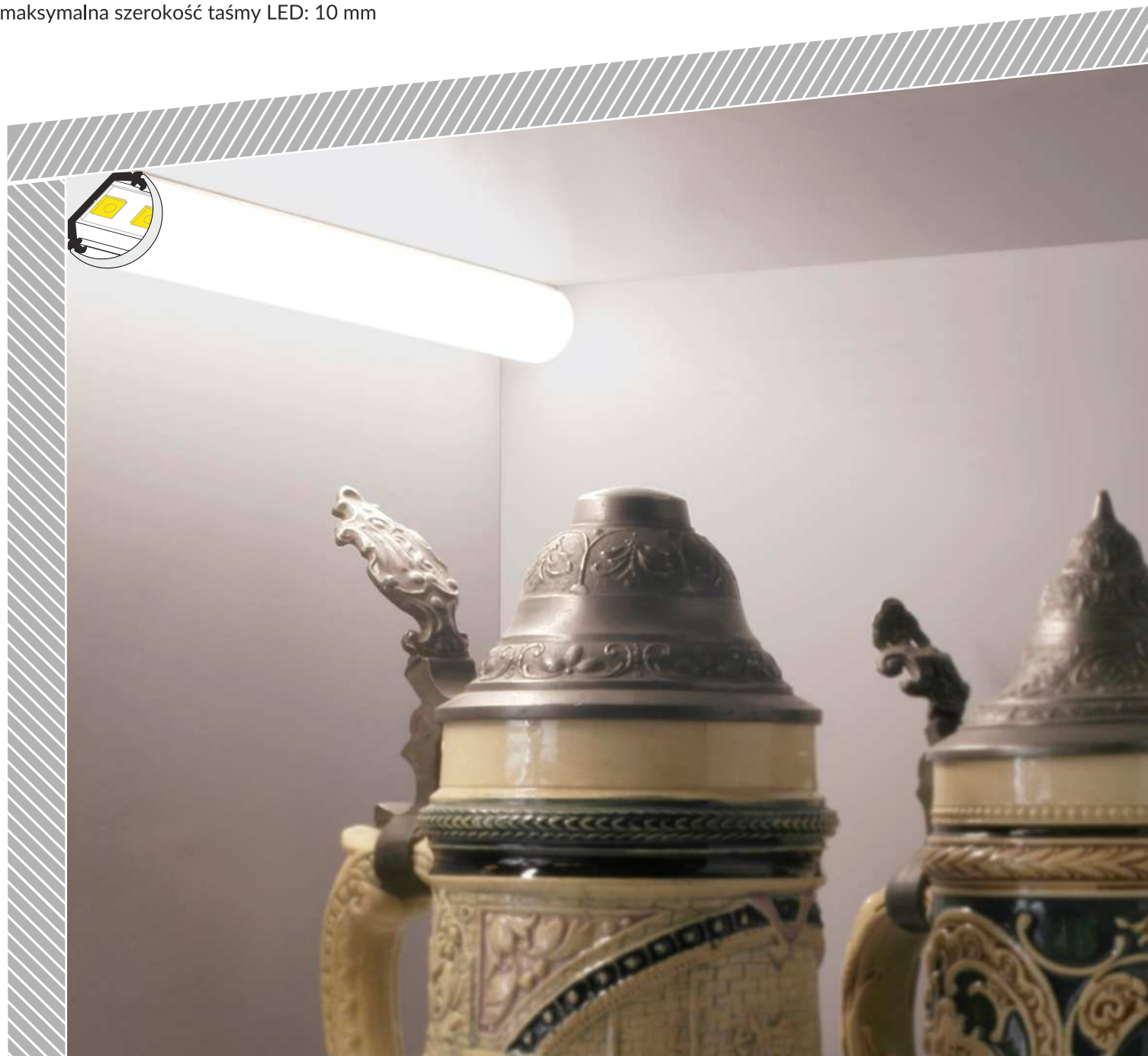

## SIMILAR IN THE OFFER / PODOBNE W OFERCIE



TRIO10  
BC



CORNER10  
BC/UX



CAB12  
E



CORNER14  
EF/TY



CORNER27  
G/UX



**B** slide cover  
klosz B wsuwany

**D** click cover  
klosz D klik

**U6**<sup>1</sup> U6 mounting plate  
uchwyt U6

**U6**<sup>2</sup> cone U6 mounting plate  
uchwyt U6 cone

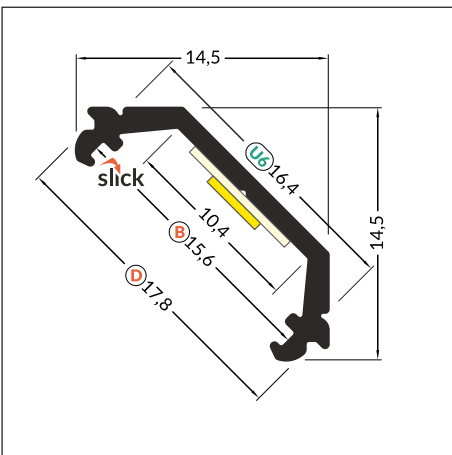
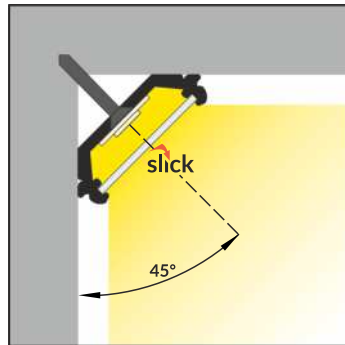
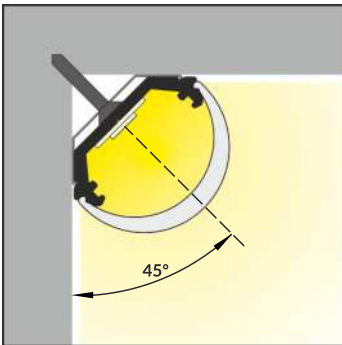
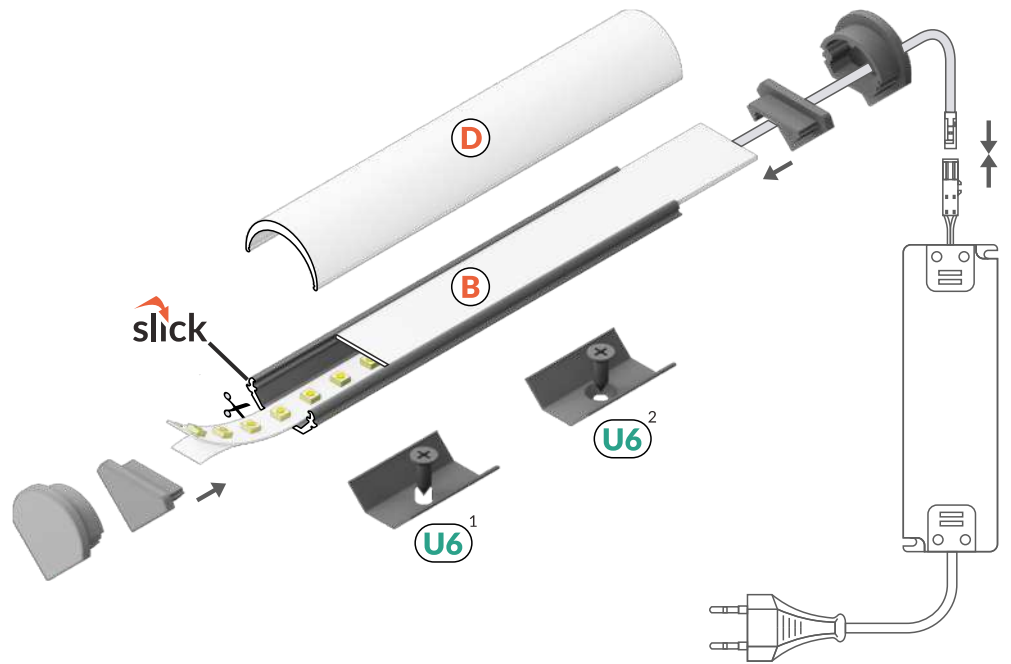

INDEX = 1 pc, length 2000 mm  
package = 10 pcs  
INDEKS = 1 szt., długość 2000 mm  
opakowanie = 10 szt.

 anodized  
anodowany  
D3020020

Available lengths / Dostępne długości  
1000 mm, 2000 mm, 3000 mm, 4000 mm



## COVERS / KLOSZE

### B slide cover

colours: transparent, frosted, white  
material: PC, PP, PP

klosz B wsuwany  
kolory: transparentny, szron, mleczny  
materiał: PC, PP, PP

### D click cover

colour: white  
material: PMMA

klosz D klik  
kolor: mleczny  
materiał: PMMA



**Note!** Dimensions of the space to install LED source  
**Uwaga!** Wymiary przestrzeni do zamontowania źródła LED

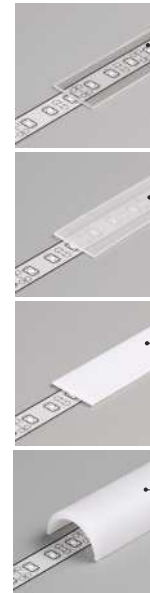
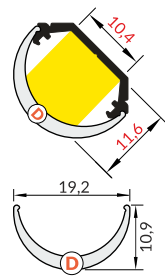
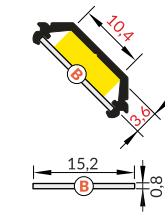

INDEX = 1 pc, length 2000 mm  
package = 10 pcs  
INDEKS = 1 szt., długość 2000 mm  
opakowanie = 10 szt.

B transparent / B transparentny  
76250016

B frosted / B szron  
76250039

B white / B mleczny  
76250038

D white / D mleczny  
A1140038

## ENDINGS / ZAŚLEPKI

### QUARTER10 ending

colours: silver, grey  
material: ABS  
zaślepka QUARTER10  
kolory: srebrno, szary  
materiał: ABS



Ending with marked space to bore the holes.  
Zaślepka z punktami do przewiercenia otworów.

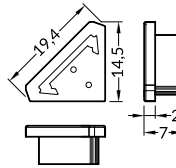

### QUARTER10 D ending

colours: silver, grey  
material: ABS  
zaślepka QUARTER10 D  
kolory: srebrno, szary  
materiał: ABS

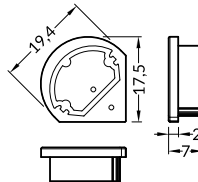

INDEX = 1 set  
package of 10 sets = 20 pcs  
INDEKS = 1 komplet  
opakowanie zawiera 10 kpl = 20 szt

silver / srebrne D3980040

grey / szary D3980022

silver / srebrne D3990040

grey / szary D3990022

## MOUNTINGS / MOCOWANIA

### U6 mounting plate

colours: inox  
material: stainless steel

uchwyt U6  
kolory: inox  
materiał: stal nierdzewna

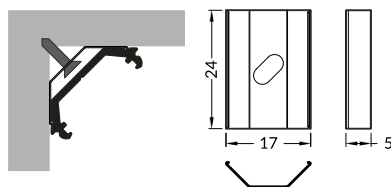

INDEX = 1 set  
package of 10 sets = 20 pcs  
INDEKS = 1 komplet  
opakowanie zawiera 10 kpl = 20 szt

U6 mounting plate  
uchwyt U6

inox / inox D3960019

### cone U6 mounting plate

colours: inox  
material: stainless steel

uchwyt U6 cone  
kolory: inox  
materiał: stal nierdzewna

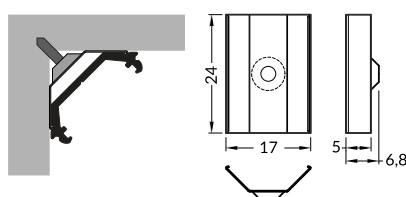

cone U6 mounting plate  
uchwyt U6 cone

inox / inox D3970019



## A PROFILE FOR SHOW CASE'S INSIDE VERTICAL AND HORIZONTAL ILLUMINATION

### PROFIL DO OŚWIETLENIA WNĘTRZA GABLOTY W PIONIE I POZIOMIE

- decorative and lighting profile
- two lighting angles: 30°/60°
- small sizes, no holders and a channel for hiding cables - minimum interference in glass show case's look
- Slick socket
- maximum LED strip width: 14 mm
- profil dekoracyjno-oświetleniowy
- dwa kąty świecenia: 30°/60°
- niewielkie gabaryty, brak uchwytów oraz kanał do schowania przewodów - minimalna ingerencja w wygląd szklanej gabloty
- gniazdo z funkcją Slick
- taśmy LED: 14 mm

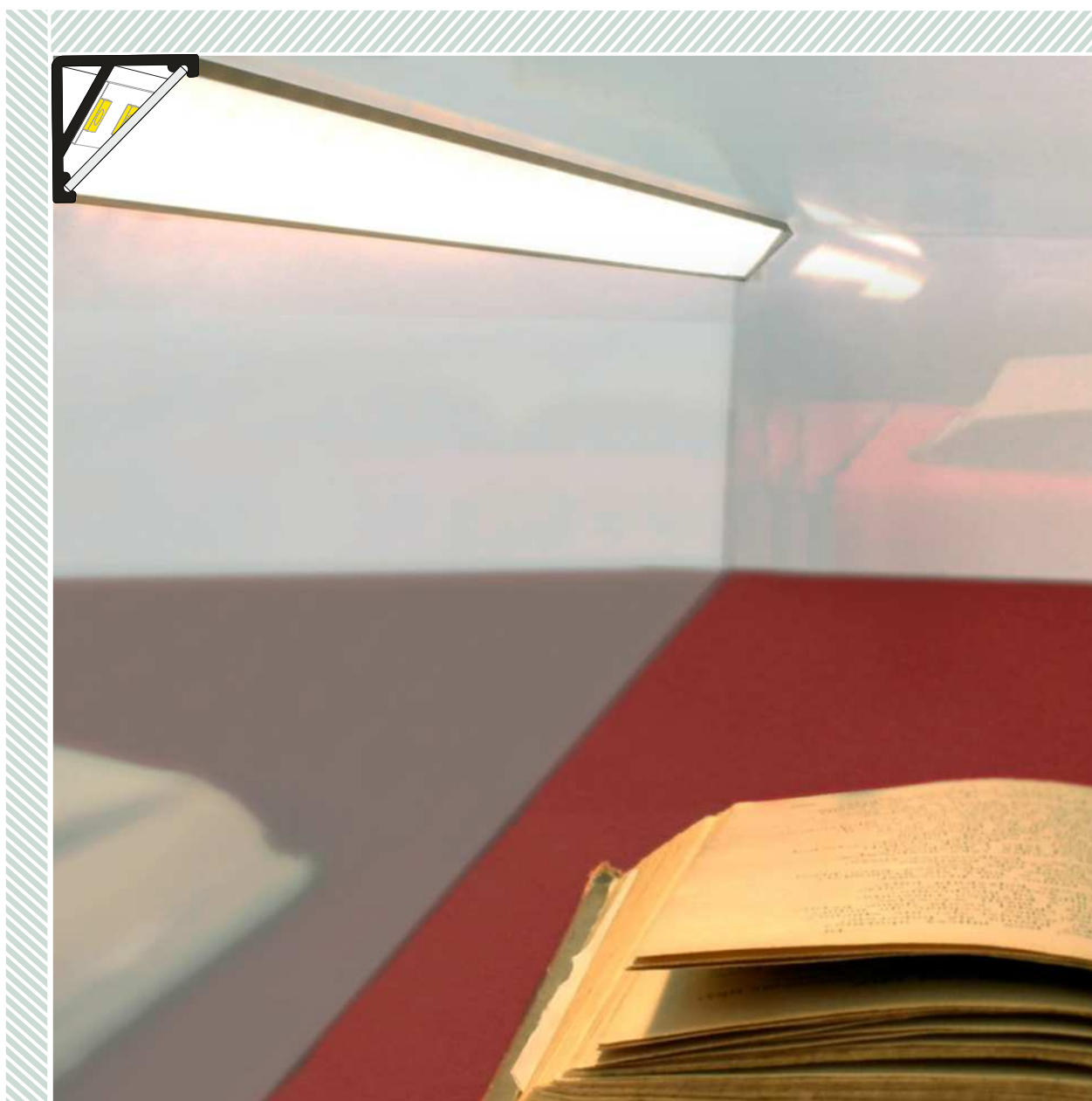

### SIMILAR IN THE OFFER / PODOBNE W OFERCIE



TRIO10  
BC



CORNER10  
BC/UX



QUARTER10  
BD/U6



CORNER14  
EF/TY



CORNER27  
G/UX



PEN8  
I



**E** slide cover  
klosz E wsuwany

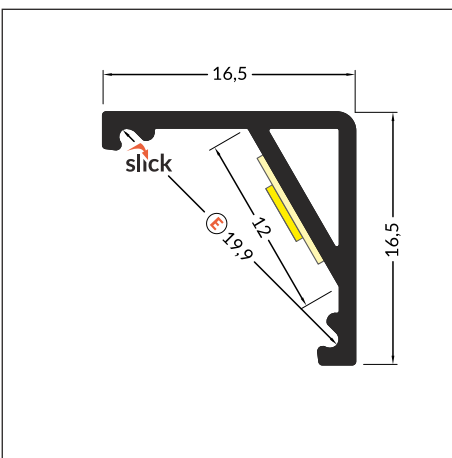
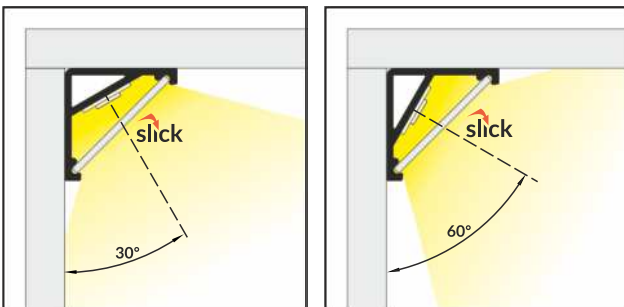
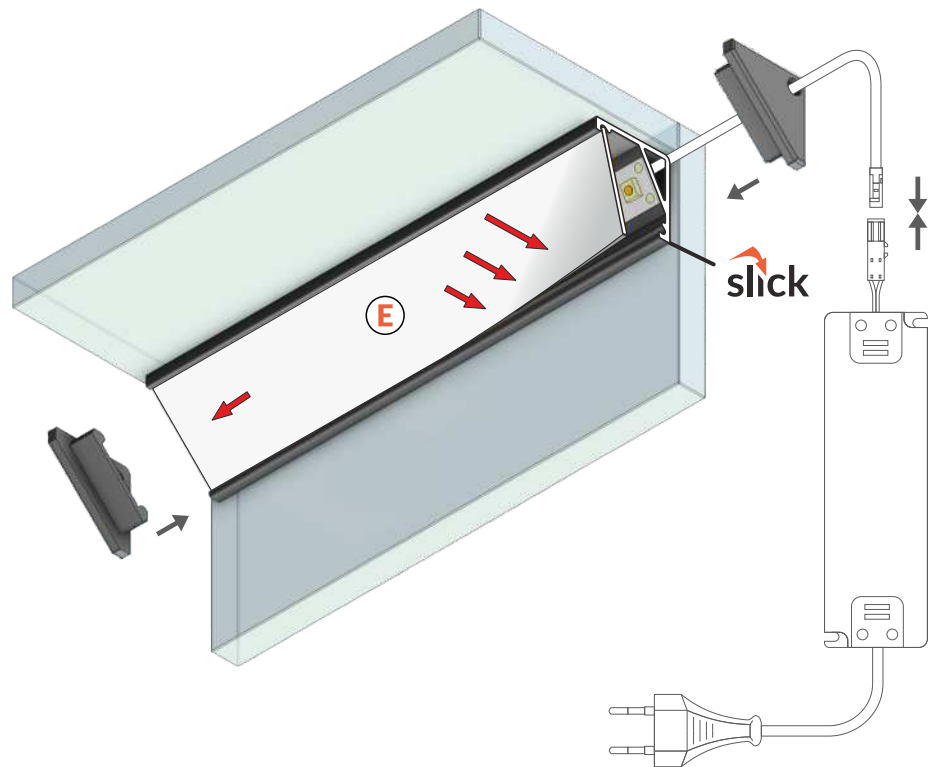

 max 12 mm

 corner  
kątowy



INDEX = 1 pc, length 2000 mm  
package = 10 pcs  
INDEKS = 1 szt., długość 2000 mm  
opakowanie = 10 szt.

 white painted  
biały malowany  
C9020001

 anodized  
anodowany  
C9020020

 black anodized  
czarny anodowany  
C9020021

 raw aluminium  
surowe aluminium  
C9020000

Available lengths / Dostępne długości  
1000 mm, 2000 mm



## COVERS / KLOSZE

**E slide cover**  
colours: transparent, frosted, white  
material: PC, PP, PP

klosz E wsuwany  
kolory: transparentny, szron, mleczny  
materiał: PC, PP, PP



**Note!** Dimensions of the space to install LED source  
**Uwaga!** Wymiary przestrzeni do zamontowania źródła LED

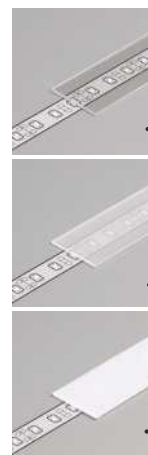
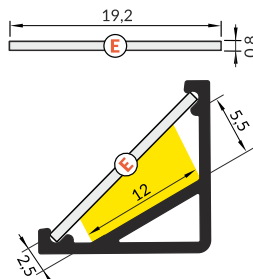

INDEX = 1 pc, length 2000 mm  
package = 10 pcs  
INDEKS = 1 szt., długość 2000 mm  
opakowanie = 10 szt.

**E transparent / E transparentny**  
A2040016

**E frosted / E szron**  
A2040039

**E white / E mleczny**  
A2040038

## ENDINGS / ZAŚLEPKI

**CABI12 ending**  
colours: white, silver, black, grey  
material: ABS

zaślepka CABI12  
kolory: biały, srebrny, czarny, szary  
materiał: ABS

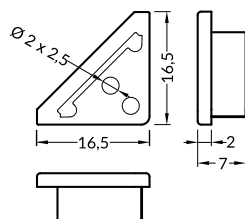

Ending with marked space to bore the holes.  
Zaślepka z punktami do przewiercenia otworów.

INDEX = 1 set  
package of 10 sets = 20 pcs  
INDEKS = 1 komplet, opakowanie  
zawiera 10 kompletów = 20 szt.

-  white  
białe C9980001
-  silver  
srebrne C9980040
-  black  
czarne C9980002
-  grey  
szare C9980022





#### **INVISIBLE WIRES**

Special channel to hide the wires allows to remain esthetic look of the showcase.

#### **NIEWIDOCZNE PRZEWODY**

Kanał do schowania przewodów pozwala zachować estetyczny wygląd gabloty.



#### **EQUAL SIDE LENGTHS**

The symmetrical profile design allows precise connections in a different configurations.

#### **RÓWNE DŁUGOŚCI BOKÓW**

Symetryczna budowa profilu umożliwia precyzyjne łączenie w różnych konfiguracjach.

# CORNER14 EF/TY

## ANGULAR PROFILE 30°/60°

### PROFIL KĄTOWY 30°/60°

- decorative and lighting profile
- hidden mounting
- two lighting angles: 30°/60°
- maximum LED strip width: 14 mm
- profil dekoracyjno-oświetleniowy
- ukryte mocowanie
- dwa kąty świecenia: 30°/60°
- maksymalna szerokość taśmy LED: 14 mm

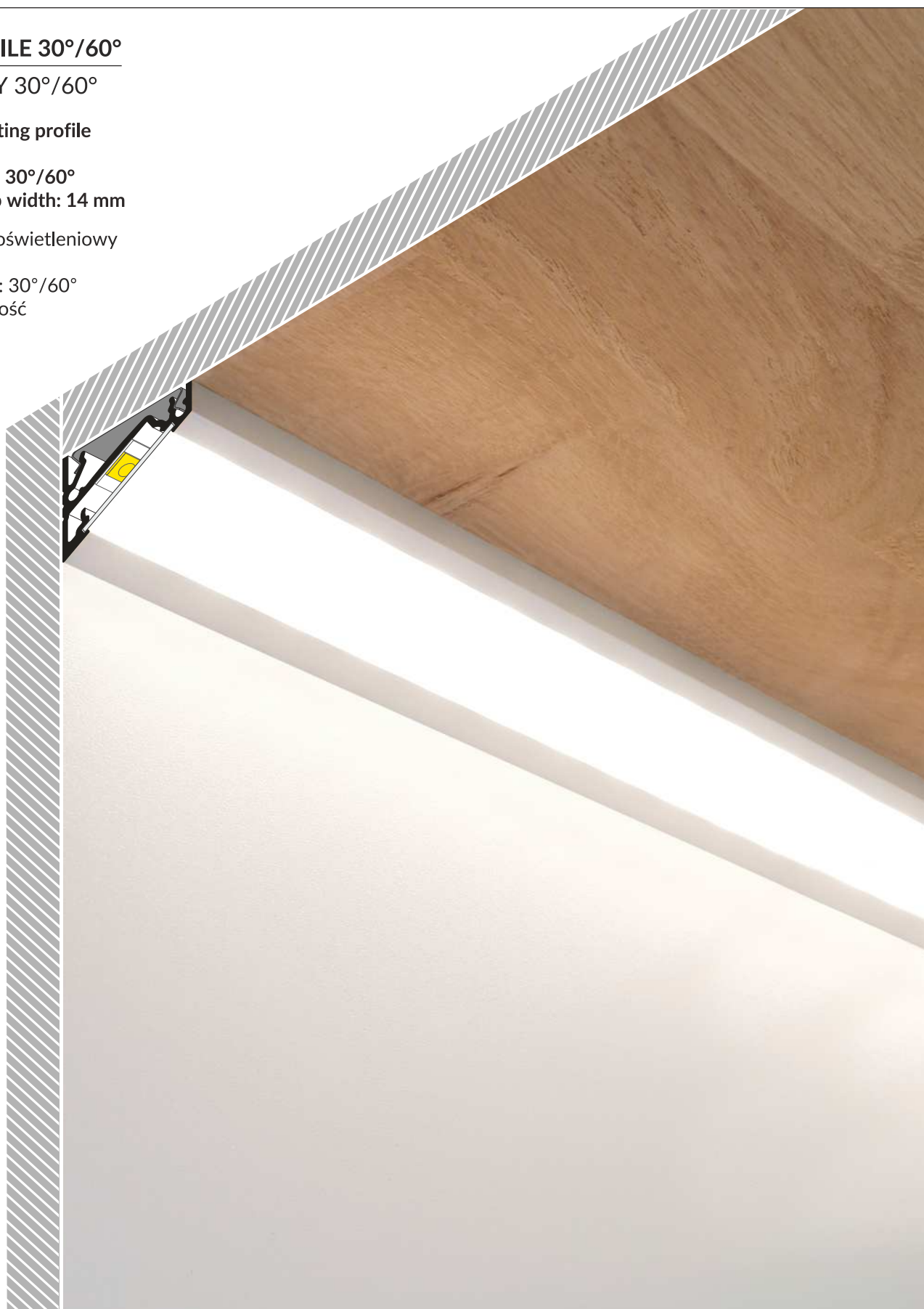

## SIMILAR IN THE OFFER / PODOBNE W OFERCIE



TRIO10  
BC



CORNER10  
BC/UX



QUARTER10  
BD/U6



CABI12  
E



CORNER27  
G/UX



**E** **E** slide cover  
klosz **E** wsuwany

**F** **F** click cover  
klosz **F** klik

**E7** **E7** click cover  
klosz **E7** klik

**Y**<sup>1</sup> **Y** flexible mounting plate  
uchwyt **Y** sprężysty

**Y**<sup>2</sup> **cone Y** flexible mounting plate  
uchwyt **Y** sprężysty cone

**T** **T** mounting plate  
uchwyt **T**

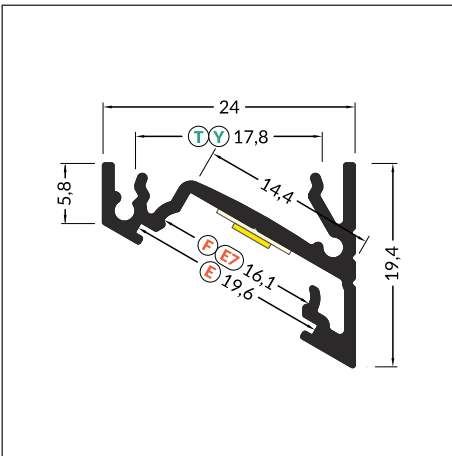
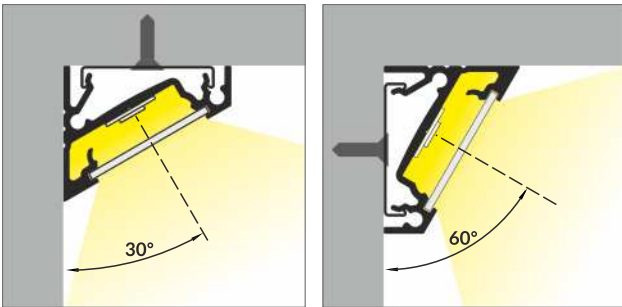
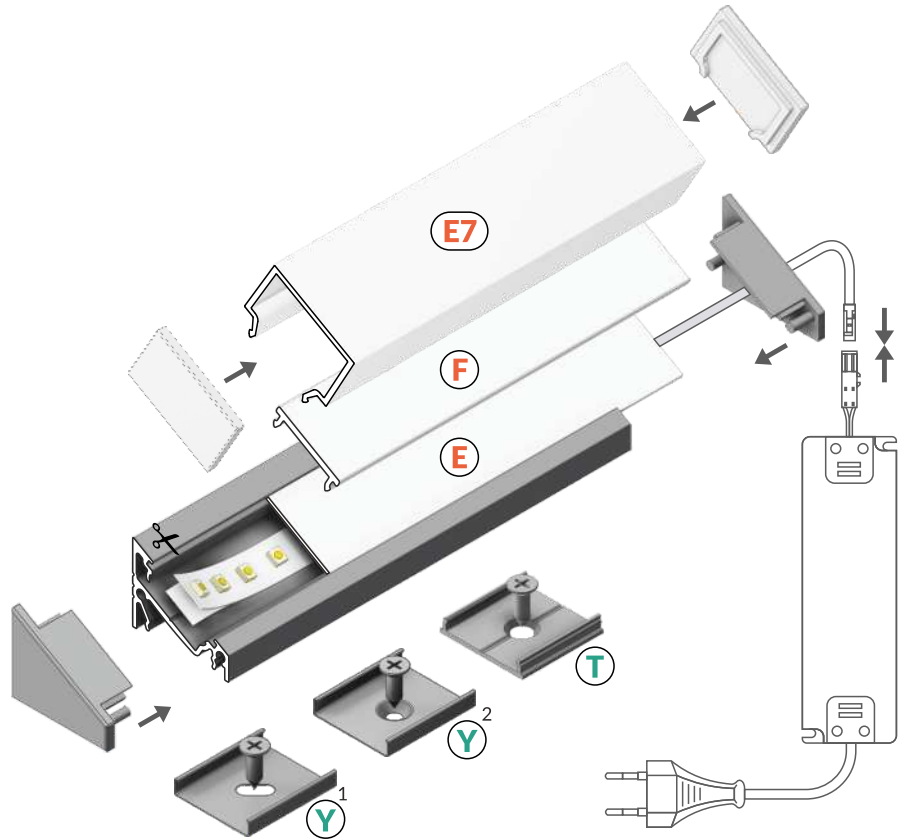

INDEX = 1 pc, length 2000 mm  
package = 10 pcs  
INDEKS = 1 szt., długość 2000 mm  
opakowanie = 10 szt.

 white painted  
biały malowany  
A4020001

 anodized  
anodowany  
A4020020

 black anodized  
czarny anodowany  
A4020021

 raw aluminium  
surowe aluminium  
A4020000



 max 14 mm

 corner  
kątowy

Available lengths / Dostępne długości  
1000 mm, 2000 mm, 3000 mm, 4000 mm



## COVERS / KLOSZE

**E slide cover**  
colours: transparent, frosted, white  
material: PC, PP, PP

klosz E wsuwany  
kolory: transparentny, szron, mleczny  
materiał: PC, PP, PP



**Note!** Dimensions of the space to install LED source  
**Uwaga!** Wymiary przestrzeni do zamontowania źródła LED

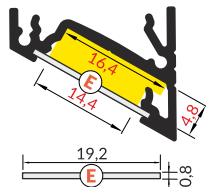

**F click cover**  
colours: transparent, white  
material: PMMA

klosz F klik  
kolory: transparentny, mleczny  
materiał: PMMA

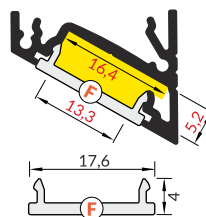

**E7 click cover**  
colour: white  
material: PMMA

klosz E7 klik  
kolor: mleczny  
materiał: PMMA

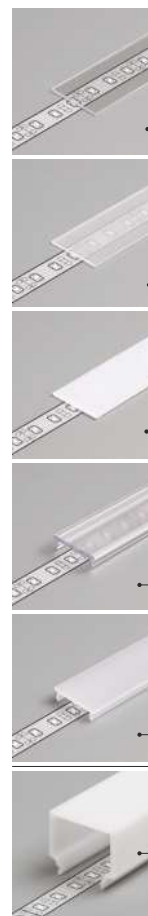
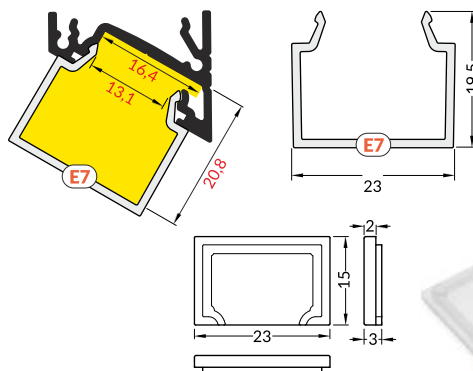

INDEX = 1 pc, length 2000 mm  
package = 10 pcs  
INDEKS = 1 szt., długość 2000 mm  
opakowanie = 10 szt.

E transparent / E transparentny  
A2040016

E frosted / E szron  
A2040039

E white / E mleczny  
A2040038

F transparent / F transparentny  
A2060016

F white / F mleczny  
A2060038

E7 white / E7 mleczny  
C1080038

INDEX = 1 set  
package of 10 sets = 20 pcs  
INDEKS = 1 komplet, opakowanie  
zawiera 10 kompletów = 20 szt.

E7 white ending  
zaślepka E7 mleczny  
C1840038

## MOUNTING / MOCOWANIA

**Y flexible mounting plate**  
colour: inox  
material: stainless steel

uchwyt Y sprężysty  
kolor: inox  
materiał: stal nierdzewna

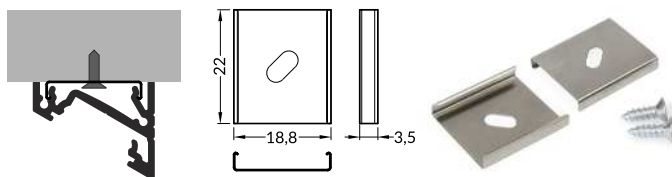

INDEX = 1 set  
package of 10 sets = 20 pcs  
INDEKS = 1 komplet, opakowanie  
zawiera 10 kompletów = 20 szt.

Y flexible mounting plate  
uchwyt Y sprężysty

inox  
inox A2090019

**cone Y flexible mounting plate**  
colour: inox  
material: stainless steel

uchwyt Y sprężysty cone  
kolor: inox  
materiał: stal nierdzewna

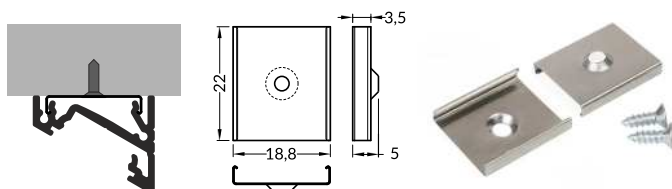

cone Y flexible mounting plate  
uchwyt Y sprężysty cone

inox  
inox A2130019

**T mounting plate**  
colour: raw aluminium  
material: aluminium

uchwyt T  
kolor: surowe aluminium  
materiał: aluminium

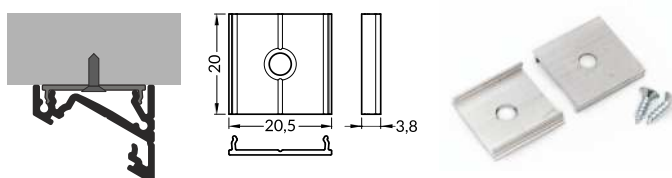

T mounting plate  
uchwyt T

raw aluminium  
surowe aluminium  
C6960000



## ENDINGS / ZAŚLEPKI

### CORNER14 ending

colours: white, silver, black, grey  
material: ABS

zaślepka CORNER14

kolory: biały, srebrny, czarny, szary  
material: ABS

### CORNER14 ending with hole

colours: white, silver, black, grey  
material: ABS

zaślepka CORNER14 z otworem

kolory: biały, srebrny, czarny, szary  
material: ABS

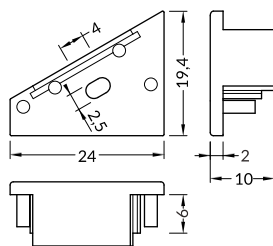

INDEX = 1 set  
package of 10 sets = 20 pcs  
INDEKS = 1 komplet, opakowanie  
zawiera 10 kompletów = 20 szt.

○ white  
białe

with hole  
z otworem  
A4050001

without hole  
bez otworu  
A4070001

● silver  
srebrne

with hole  
z otworem  
A4050040

without hole  
bez otworu  
A4070040

● black  
czarne

with hole  
z otworem  
A4050002

without hole  
bez otworu  
A4070002

● grey  
szare

with hole  
z otworem  
A4050022

without hole  
bez otworu  
A4070022

## CONNECTORS / ŁĄCZNIKI

### T connector

colour: raw aluminium  
material: aluminium

łącznik T

kolor: surowe aluminium  
material: aluminium

### CORNER14 connector 90 deg

colours: white, anodized, black  
material: aluminium

łącznik CORNER14 90 st

kolory: biały, anodowany, czarny  
material: aluminium

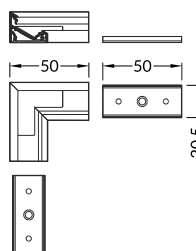
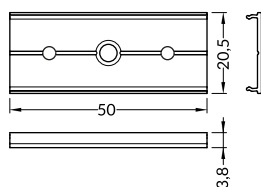

INDEX = 1 set  
INDEKS = 1 komplet

T connector / łącznik T

● raw aluminium  
surowe aluminium  
C6990000

connector 90 deg / łącznik 90 st

○ white painted  
biały malowany  
A4990001

● anodized  
anodowany  
A4990020

● black anodized  
czarny anodowany  
A4990021

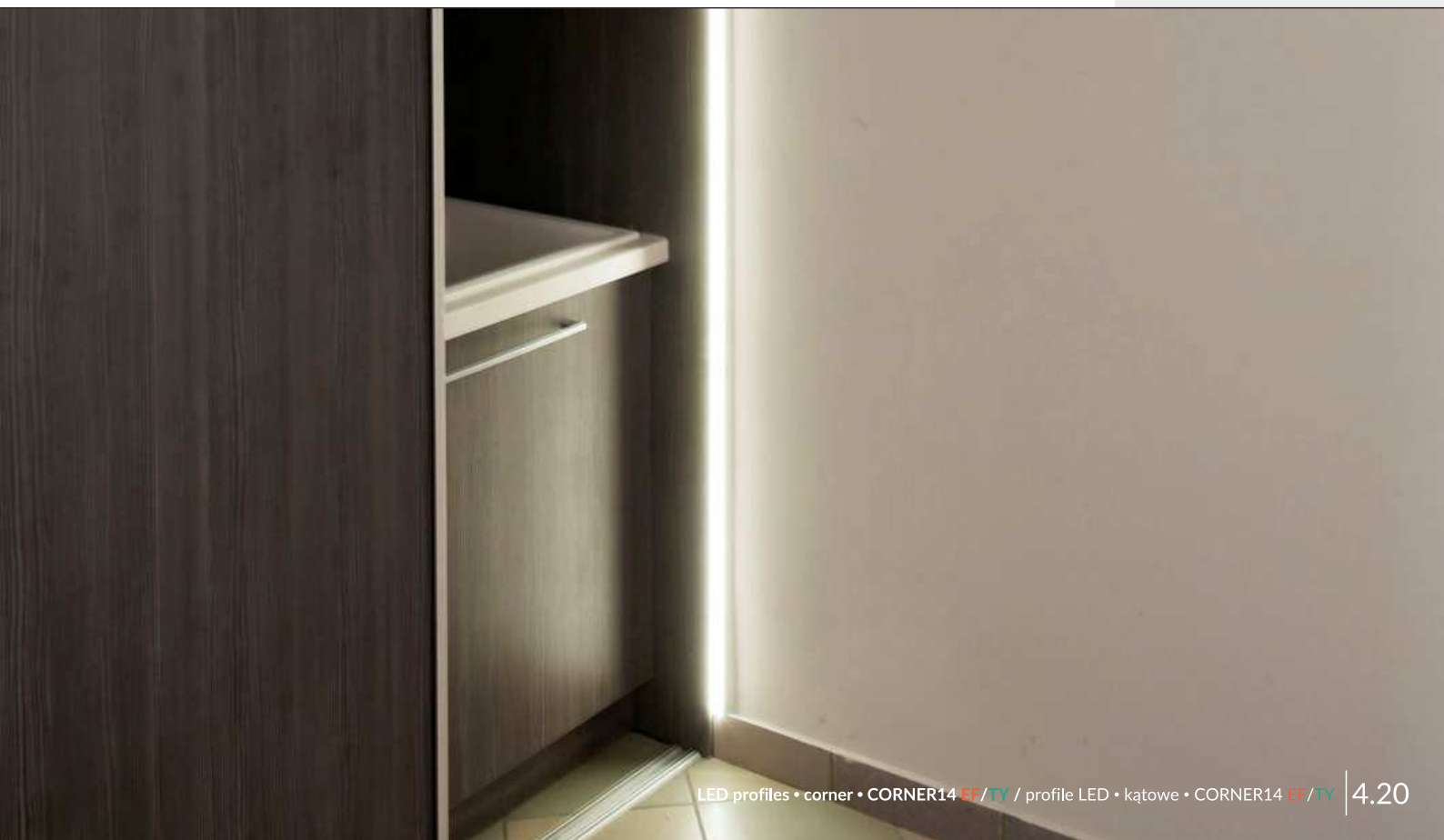

# CORNER27 G/UX

## LARGE-SIZE ANGULAR PROFILE

### WIELKOGABARYTOWY PROFIL KĄTOWY

- lighting profile - possibility of high lumen output
- hidden mounting
- two lighting angles: 30° or 60°
- maximum LED strip width: 27 mm or 3 standard strips (8 mm)
- profil oświetleniowy - możliwość uzyskania dużej wydajności
- ukryte mocowanie
- dwa kąty świecenia: 30 i 60°
- maksymalna szerokość taśmy LED: 27 mm albo do 3 taśm standardowych (8 mm)



## SIMILAR IN THE OFFER / PODOBNE W OFERCIE



TRIO10  
BC



CORNER10  
BC/UX



QUARTER10  
BD/U6



CABI12  
E



CORNER14  
EF/TY



**G** slide cover  
klosz G wsuwany

**U**<sup>1</sup> flexible mounting plate  
uchwyt U sprężysty

**U**<sup>2</sup> cone U flexible mounting plate  
uchwyt U sprężysty cone

**X**<sup>1</sup> X mounting plate  
uchwyt X

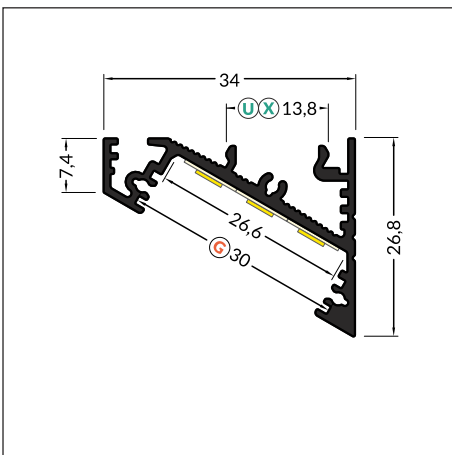
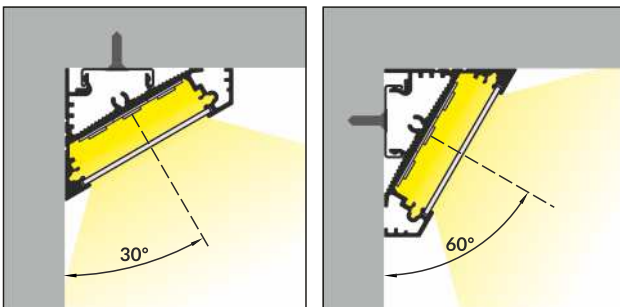
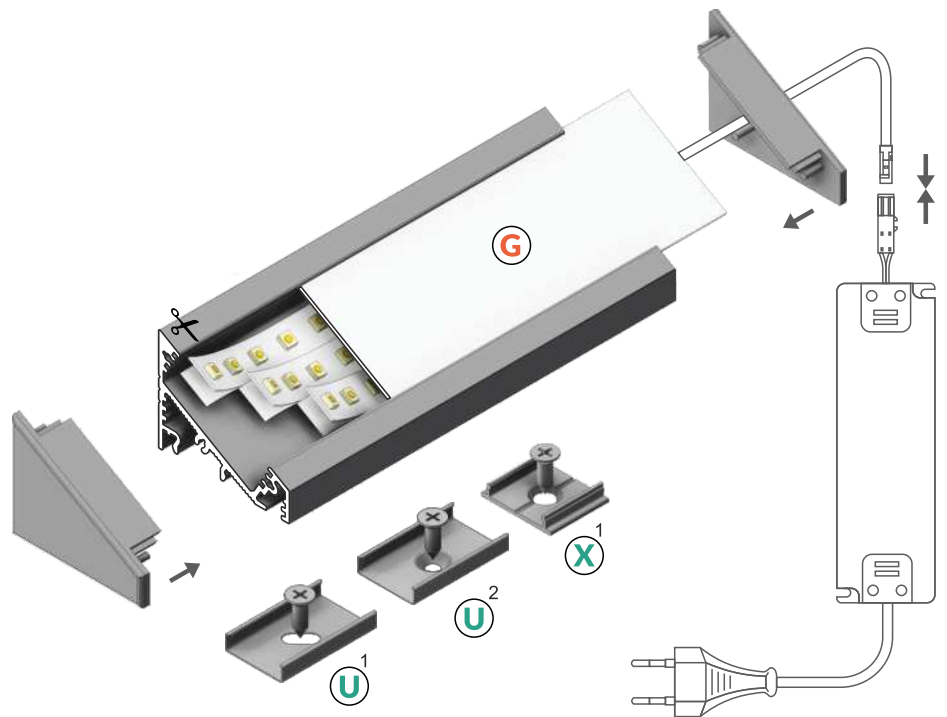

INDEX = 1 pc, length 2000 mm  
package = 10 pcs  
INDEKS = 1 szt., długość 2000 mm  
opakowanie = 10 szt.

○ white painted  
biały malowany  
98030001



● anodized  
anodowany  
98030020



● black anodized  
czarny anodowany  
98030021

Available lengths / Dostępne długości  
1000 mm, 2000 mm, 3000 mm, 4000 mm

max 27 mm

corner  
kątowy



## COVERS / KLOSZE

**G slide cover**  
colours: transparent, frosted, white  
material: PC, PP, PP

klosz **G** wsuwany  
kolory: transparentny, szron, mleczny  
materiał: PC, PP, PP

**Note!** Dimensions of the space  
to install LED source  
**Uwaga!** Wymiary przestrzeni  
do zamontowania źródła LED

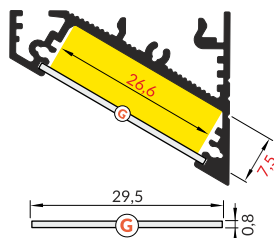

INDEX = 1 pc, length 2000 mm  
package = 10 pcs  
INDEKS = 1 szt., długość 2000 mm  
opakowanie = 10 szt.

**G transparent / G transparentny**  
84070016

**G frosted / G szron**  
84070039

**G white / G mleczny**  
84070038

## ENDINGS / ZAŚLEPKI

**CORNER27 ending**  
colours: white, silver, black, grey  
material: ABS

zaślepka CORNER27  
kolory: biały, srebrny, czarny, szary  
materiał: ABS

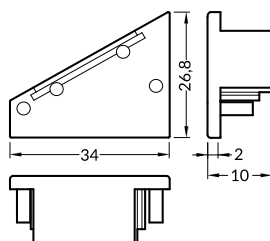

INDEX = 1 set,  
package of 10 sets = 20 pcs  
INDEKS = 1 komplet, opakowanie  
zawiera 10 kompletów = 20 szt.

white  
białe 98050001

silver  
srebrne 98050040

black  
czarne 98050002

grey  
szare 98050022

## MOUNTINGS / MOCOWANIA

**U flexible mounting plate**  
colour: inox  
material: stainless steel

uchwyt **U** sprężysty  
kolor: inox  
materiał: stal nierdzewna

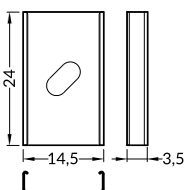
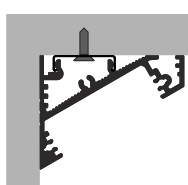

INDEX = 1 set  
package of 10 sets = 20 pcs  
INDEKS = 1 komplet  
opakowanie zawiera 10 kpl = 20 szt

**U flexible mounting plate**  
uchwyt **U** sprężysty

inox  
inox  
76380000

**cone U flexible mounting plate**  
colour: inox  
material: stainless steel

uchwyt **U** sprężysty cone  
kolor: inox  
materiał: stal nierdzewna

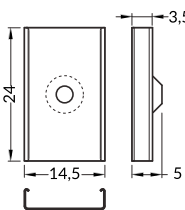
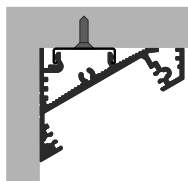

**cone U flexible mounting plate**  
uchwyt **U** sprężysty cone

inox  
inox  
76620000

**X mounting plate**  
colour: raw aluminium  
material: aluminium

uchwyt **X**  
kolor: surowe aluminium  
materiał: aluminium

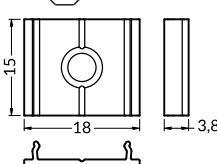
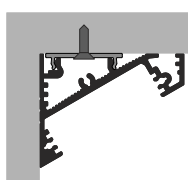

**X mounting plate**  
uchwyt **X**

raw aluminium  
surowe aluminium  
76260000

## CONNECTORS / ŁĄCZNIKI

**X connector**  
colour: raw aluminium  
material: aluminium

łącznik **X**  
kolor: surowe aluminium  
materiał: aluminium

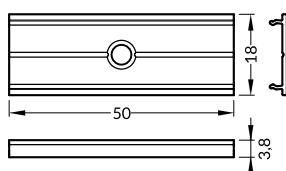

INDEX = 1 set  
INDEKS = 1 komplet

raw aluminium  
surowe aluminium  
76350000









**SPECIAL APPLICATION**  
**SPECJALNE**

**2017**

**LED profiles**  
**profile LED**

# PEN8 |

## MULTI-PURPOSE ALUMINIUM PROFILE

### ALUMINOWY PROFIL UNIWERSALNY

- decorative and lighting profile, eg. for glass cabinets
- 9 types of mountings: for horizontal or vertical lighting (also with adjustment)
- possibility of mounting between the walls of a cabinet
- maximum LED strip width: 8 mm
- profil dekoracyjno-oświetleniowy, np. do szklanych gablot
- 9 rodzajów mocowań: do oświetlania pionowego lub poziomego (również z regulacją)
- możliwość mocowania pomiędzy ściankami
- maksymalna szerokość taśmy LED: 8 mm



## SIMILAR IN THE OFFER / PODOBNE W OFERCIE

SMART10  
A/Z

CABI12  
E

CORNER10  
BC/UX

TRIO10  
BC

OVAL20  
BC



**I** click cover  
klosz I klik

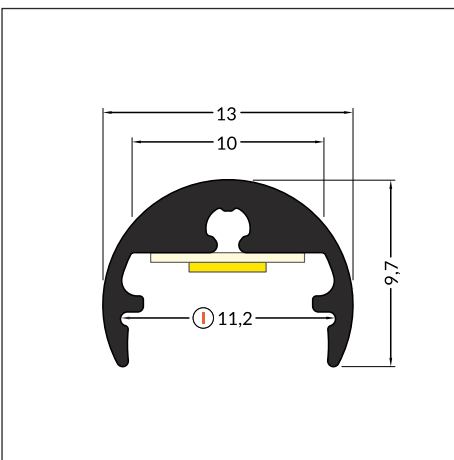
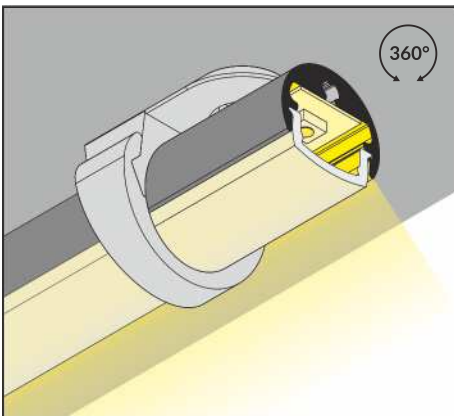
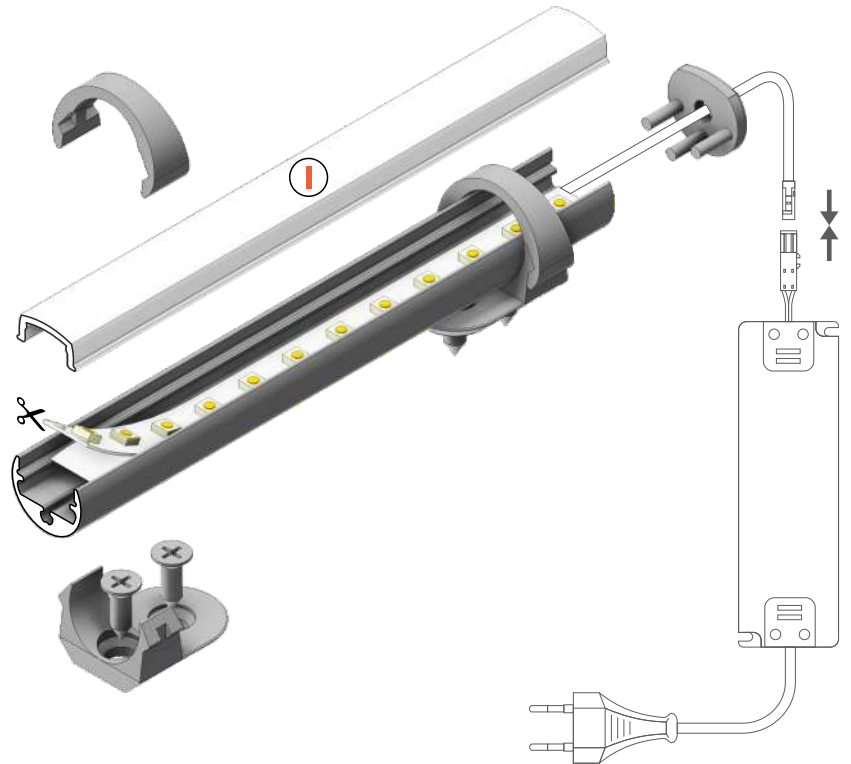

max 8 mm



special application  
specjalny

INDEX = 1 pc, length 2000 mm  
package = 10 pcs  
INDEKS = 1 szt., długość 2000 mm  
opakowanie = 10 szt.



anodized  
anodowany  
86030020

Available lengths / Dostępne długości  
1000 mm, 2000 mm, 3000 mm, 4000 mm



## COVERS / KLOSZE

**click cover**  
colour: frosted, white  
material: PC

klosz | klik  
kolor: szron, mleczny  
materiał: PC



**Note!** Dimensions of the space to install LED source  
**Uwaga!** Wymiary przestrzeni do zamontowania źródła LED

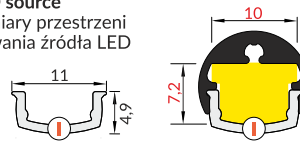

INDEX = 1 pc, length 2000 mm  
package = 10 pcs  
INDEKS = 1 szt., długość 2000 mm  
opakowanie = 10 szt.

| frosted / | szron  
86060000

| white / | mleczny  
86060038

## ENDINGS / ZAŚLEPKI

**PEN8 ending**  
colours: silver, grey  
material: ABS

zaślepka PEN8  
kolory: srebrny, szary  
materiał: ABS

**PEN8 ending with hole**  
colours: silver, grey  
material: ABS

zaślepka PEN8 z otworem  
kolory: srebrny, szary  
materiał: ABS

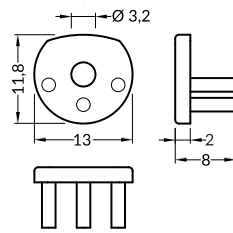

INDEX = 1 set  
package of 10 sets = 20 pcs  
INDEKS = 1 komplet, opakowanie  
zawiera 10 kompletów = 20 szt.

● silver  
srebrne

with hole  
z otworem  
86470040

without hole  
bez otworu  
86490040

● grey  
szare

with hole  
z otworem  
86470022

without hole  
bez otworu  
86490022

## MOUNTINGS / MOCOWANIA

**PEN8 flat holder**  
colour: grey  
material: ABS

uchwyt PEN8 płaski  
kolor: szary  
materiał: ABS

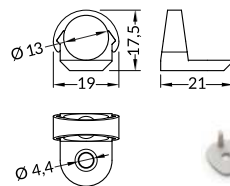
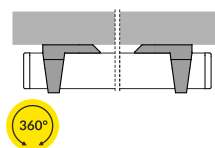

INDEX = 1 set  
package of 10 sets = 20 pcs  
INDEKS = 1 komplet  
opakowanie zawiera 10 kpl = 20 szt

flat holder  
uchwyt płaski

● grey  
szary  
86070022

**PEN8 simple holder**  
material: zinc coated steel

uchwyt PEN8 prosty  
materiał: stal ocynkowana

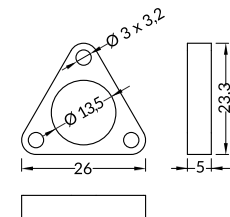
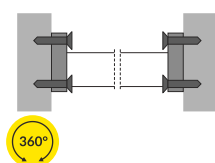

INDEX = 1 set  
INDEKS = 1 komplet

simple holder  
uchwyt prosty

● zinc coated  
stal ocynkowana  
86370030

**PEN8 stretcher holder**  
colour: chrome  
material: brass

uchwyt PEN8 rozporowy  
kolor: chrom  
materiał: mosiądz

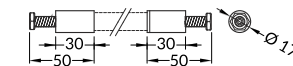
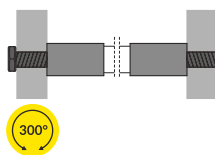

stretcher holder  
uchwyt rozporowy

● chrome  
chrom  
86290003

**PEN8 end holder**  
colour: chrome  
material: brass

uchwyt PEN8 końcowy  
kolor: chrom  
materiał: mosiądz

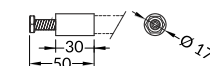
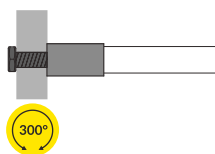

end holder  
uchwyt końcowy

● chrome  
chrom  
86160003

**PEN8 ring holder**  
colours: chrome, raw  
material: brass

uchwyt PEN8 ring  
kolory: chrome, surowy  
materiał: mosiądz

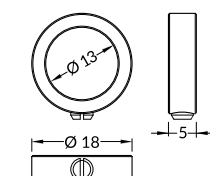
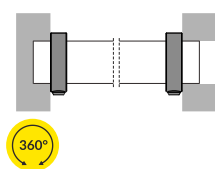

ring holder  
uchwyt ring

● chrome  
chrom  
86440003



## MOUNTINGS / MOCOWANIA

**PEN8 jointed holder with thread**  
colour: chrome  
material: steel, brass

uchwyt PEN8 przegubowy z gwintem  
kolor: chrom  
materiał: stal, mosiądz

360°

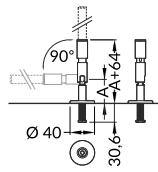

A =	INDEX = 1 set INDEKS = 1 kpl
39,4 mm	86090003
100 mm	86310003
200 mm	86110003
300 mm	86130003

**PEN8 jointed holder with soffit ceiling**  
colour: chrome  
material: steel, brass

uchwyt PEN8 przegubowy z podsufitką  
kolor: chrom  
materiał: stal, mosiądz

360°

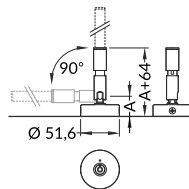

A =	INDEX = 1 set INDEKS = 1 kpl
27 mm	86080003
100 mm	86300003
200 mm	86100003
300 mm	86120003

**PEN8 double holder with thread**  
colour: chrome  
material: steel, brass

uchwyt PEN8 podwójny z gwintem  
kolor: chrom  
materiał: stal, mosiądz

300°

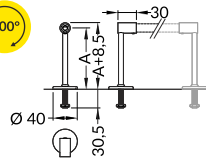

A =	INDEX = 1 set INDEKS = 1 kpl
100 mm	86330003
200 mm	86180003
300 mm	86200003

**PEN8 double holder with soffit ceiling**  
colour: chrome  
material: steel, brass

uchwyt PEN8 podwójny z podsufitką  
kolor: chrom  
materiał: stal, mosiądz

300°

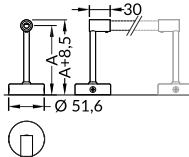

A =	INDEX = 1 set INDEKS = 1 kpl
100 mm	86320003
200 mm	86170003
300 mm	86190003

Photo: / Zdjęcie:  
PORS - Systemy Meblowe Mirosław Krysiak



# BACK10 A/UX

## TWO LIGHTING DIRECTIONS

### DWA KIERUNKI ŚWIECENIA

- decorative and lighting profile
  - the T-shaped structure makes possible to direct the light beam in two directions (up/down, left/right)
  - mounting with two dedicated holders (to the wall) or directly to the piece of furniture, using screws
  - optionally, the A cover can be used
  - maximum LED strip width: 10 mm
- profil dekoracyjno-oświetleniowy
  - konstrukcja w kształcie litery "T" pozwala na skierowanie strumienia świetlnego w dwóch kierunkach (góra/dół, lewo/prawo)
  - mocowanie za pomocą dedykowanych uchwytów (do ściany) lub bezpośrednio przy pomocy wkrętów (do mebla)
  - opcjonalne użycie klosza A
  - maksymalna szerokość taśmy LED: 10 mm

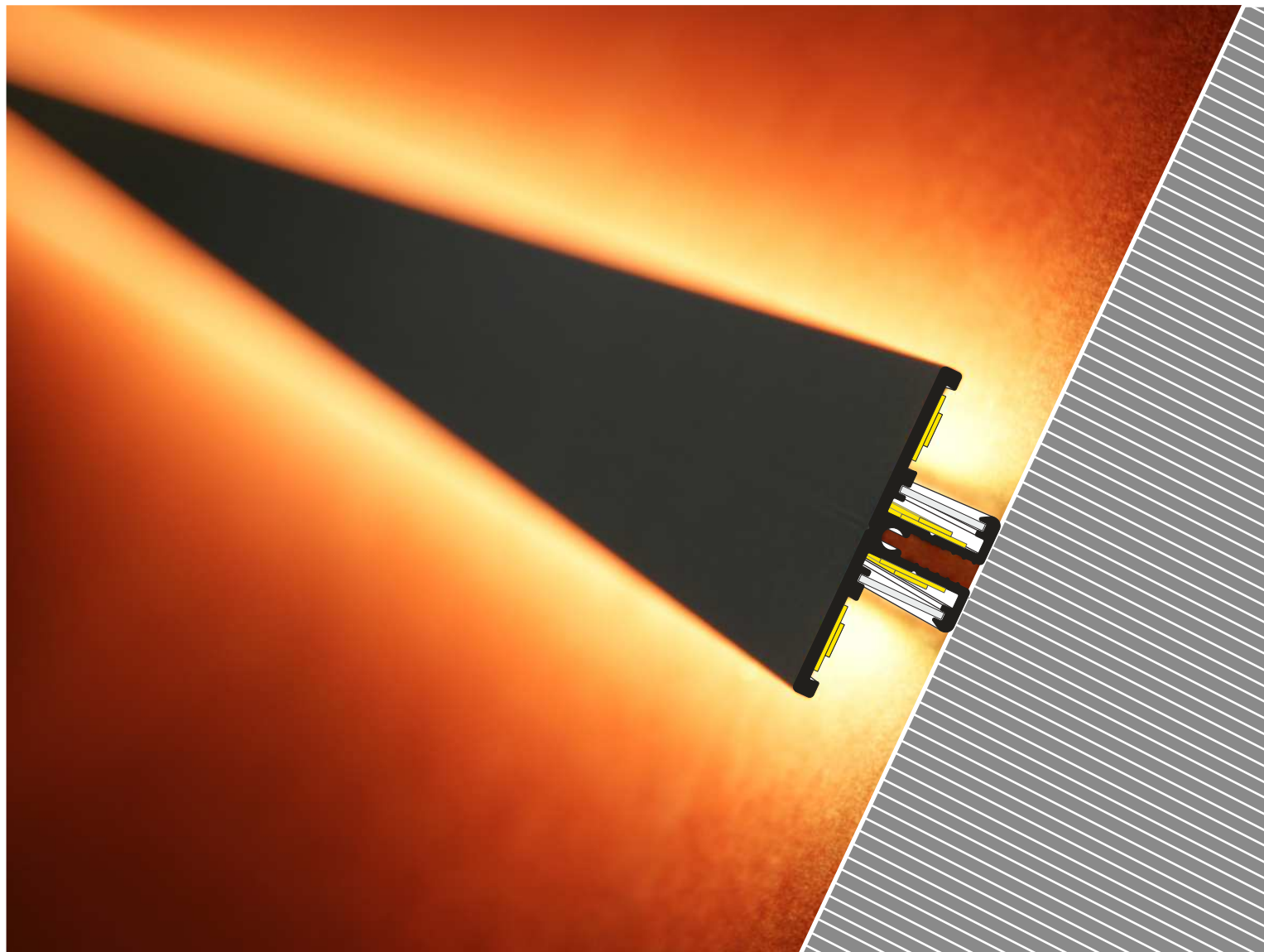

## SIMILAR IN THE OFFER / PODOBNE W OFERCIE



TWIN8



AMBI12

C



WALLE12

CD





- A** slide cover  
klosz A wsuwany
- U<sup>1</sup>** flexible mounting plate  
uchwyt U sprężysty
- U<sup>2</sup>** cone U flexible mounting plate  
uchwyt U sprężysty cone
- X<sup>1</sup>** X mounting plate  
uchwyt X

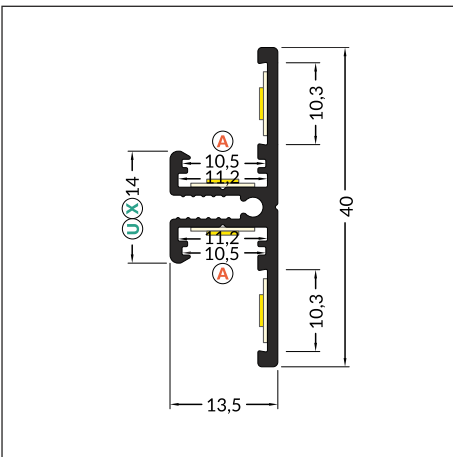
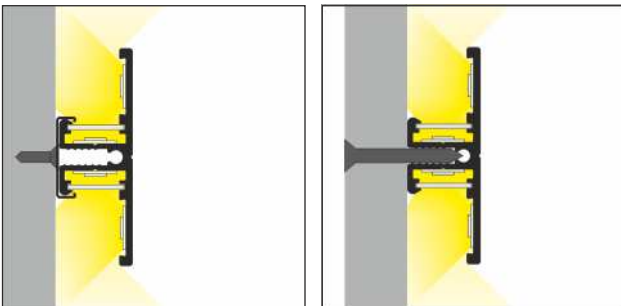
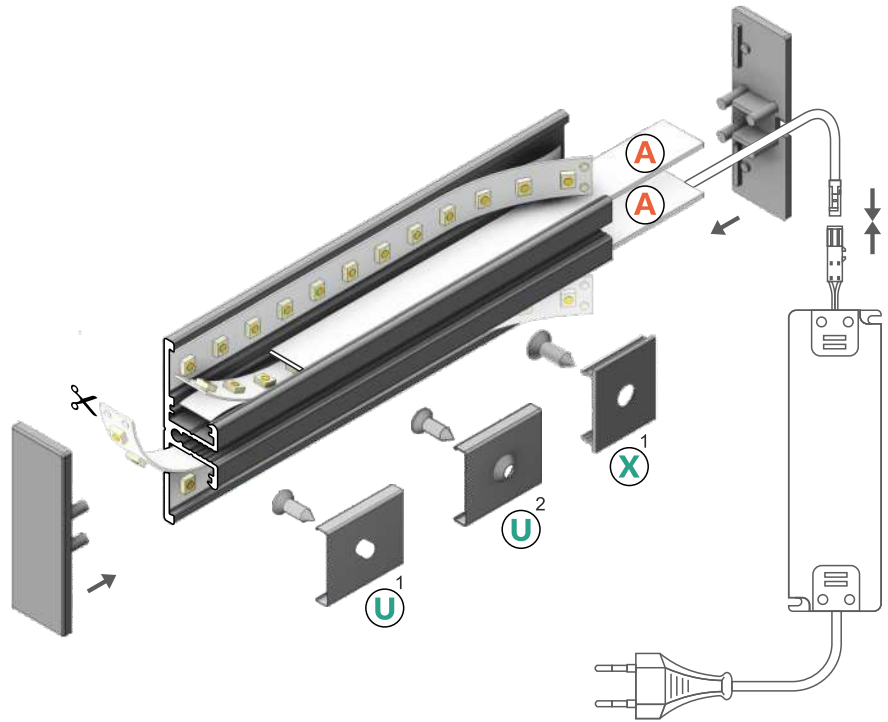

max 10 mm



special application  
specjalny



INDEX = 1 pc, length 2000 mm  
 package = 10 pcs  
 INDEKS = 1 szt., długość 2000 mm  
 opakowanie = 10 szt.



white painted  
biały malowany  
90030001



anodized  
anodowany  
90030020



black painted  
czarny malowany  
90030002



raw aluminium  
surowe aluminium  
90030000

Available lengths / Dostępne długości  
 1000 mm, 2000 mm, 3000 mm, 4000 mm



## COVERS / KLOSZE

### A slide cover

colours: transparent, frosted, white  
material: PC, PP, PP

klosz A wsuwany  
kolory: transparentny, szron, mleczny  
materiał: PC, PP, PP

**Note!** Dimensions of the space  
to install LED source  
**Uwaga!** Wymiary przestrzeni  
do zamontowania źródła LED

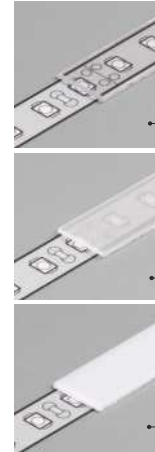
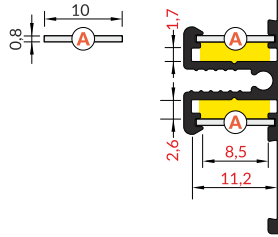

INDEX = 1 pc, length 2000 mm  
package = 10 pcs  
INDEKS = 1 szt., długość 2000 mm  
opakowanie = 10 szt.

A transparent / A transparentny  
89070016

A frosted / A szron  
89070039

A white / A mleczny  
89070038

## ENDINGS / ZAŚLEPKI

### BACK10 ending

colours: white, silver, black, grey  
material: ABS

zaślepka BACK10

kolory: biały, srebrny, czarny, szary  
materiał: ABS

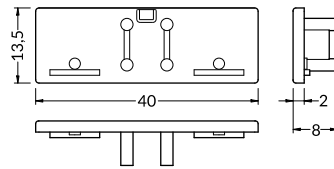

### BACK10 ending with hole

colours: white, silver, black, grey  
material: ABS

zaślepka BACK10 z otworem

kolory: biały, srebrny, czarny, szary  
materiał: ABS

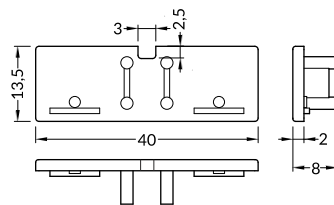

INDEX = 1 set

package of 10 sets = 20 pcs  
INDEKS = 1 komplet, opakowanie  
zawiera 10 kompletów = 20 szt.

white  
białe

with hole  
z otworem  
90150001

without hole  
bez otworu  
90100001

silver  
srebrne

with hole  
z otworem  
90150040

without hole  
bez otworu  
90100040

black  
czarne

with hole  
z otworem  
90150002

without hole  
bez otworu  
90100002

grey  
szare

with hole  
z otworem  
90150022

without hole  
bez otworu  
90100022

## MOUNTINGS / MOCOWANIA

### U flexible mounting plate

colour: inox  
material: stainless steel

uchwyt U sprężysty

color: inox  
materiał: stal nierdzewna

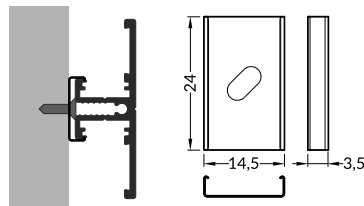

### cone U flexible mounting plate

colour: inox  
material: stainless steel

uchwyt U sprężysty cone

color: inox  
materiał: stal nierdzewna

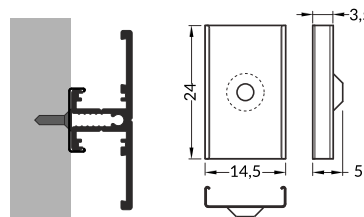

### X mounting plate

colour: raw aluminium  
material: aluminium

uchwyt X

color: surowe aluminium  
materiał: aluminium

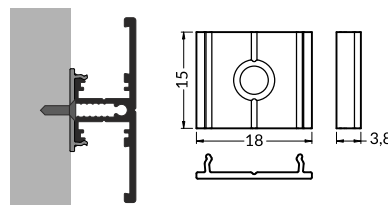

INDEX = 1 set

package of 10 sets = 20 pcs  
INDEKS = 1 komplet  
opakowanie zawiera 10 kpl = 20 szt.

U flexible mounting plate  
uchwyt U sprężysty

inox  
inox 76380000

cone U flexible mounting plate  
uchwyt U sprężysty cone

inox  
inox 76620000

X mounting plate  
uchwyt X

raw aluminium  
surowe aluminium  
76260000



## CONNECTORS / ŁĄCZNIKI

**X connector**  
colour: raw aluminium  
material: aluminium

łącznik X  
kolor: surowe aluminium  
materiał: aluminium

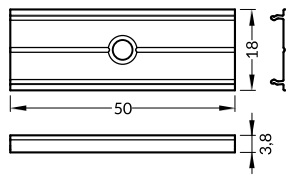

INDEX = 1 set  
INDEKS = 1 komplet

 raw aluminium  
surowe aluminium  
76350000



# STEP10 C

## STEP EDGE PROFILE

### PROFIL SCHODOWY KRAWĘDZIOWY

- highlighting or illuminating feature
- 2 mounting options - 3 lighting options to choose from
- anti slip insert installation option
- hidden mounting
- impact resistant
- maximum LED strip width: 10 mm
- światło akcentujące lub oświetleniowe
- 2 opcje montażu - 3 opcje świecenia do wyboru
- opcja montażu wkładki antypoślizgowej
- ukryte mocowanie
- odporny na udary
- maksymalna szerokość taśmy LED: 10 mm

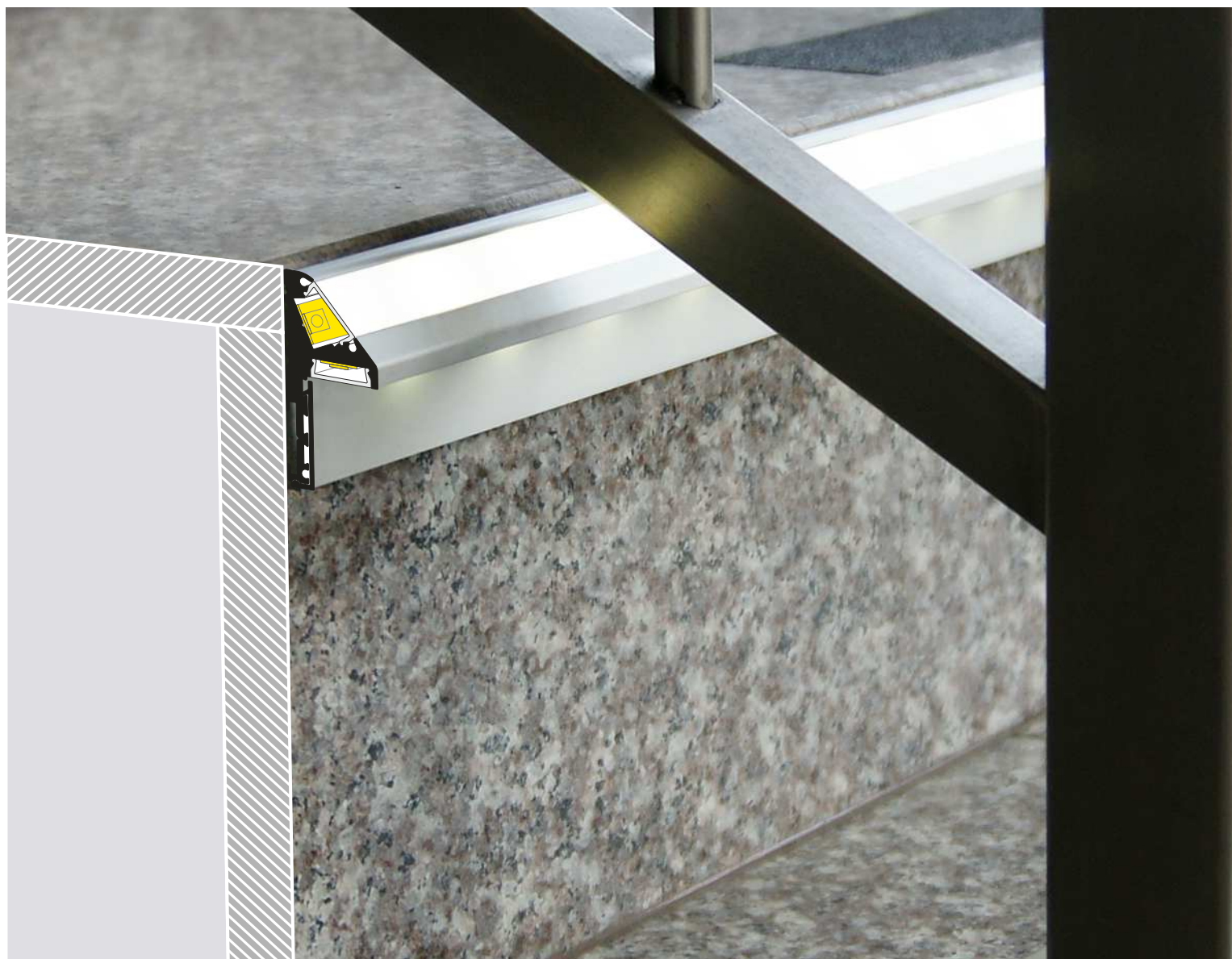

## SIMILAR IN THE OFFER / PODOBNE W OFERCIE



FLOOR12  
K/U



OUTSTAIRS12  
BC



**C** click cover  
klosz C klik

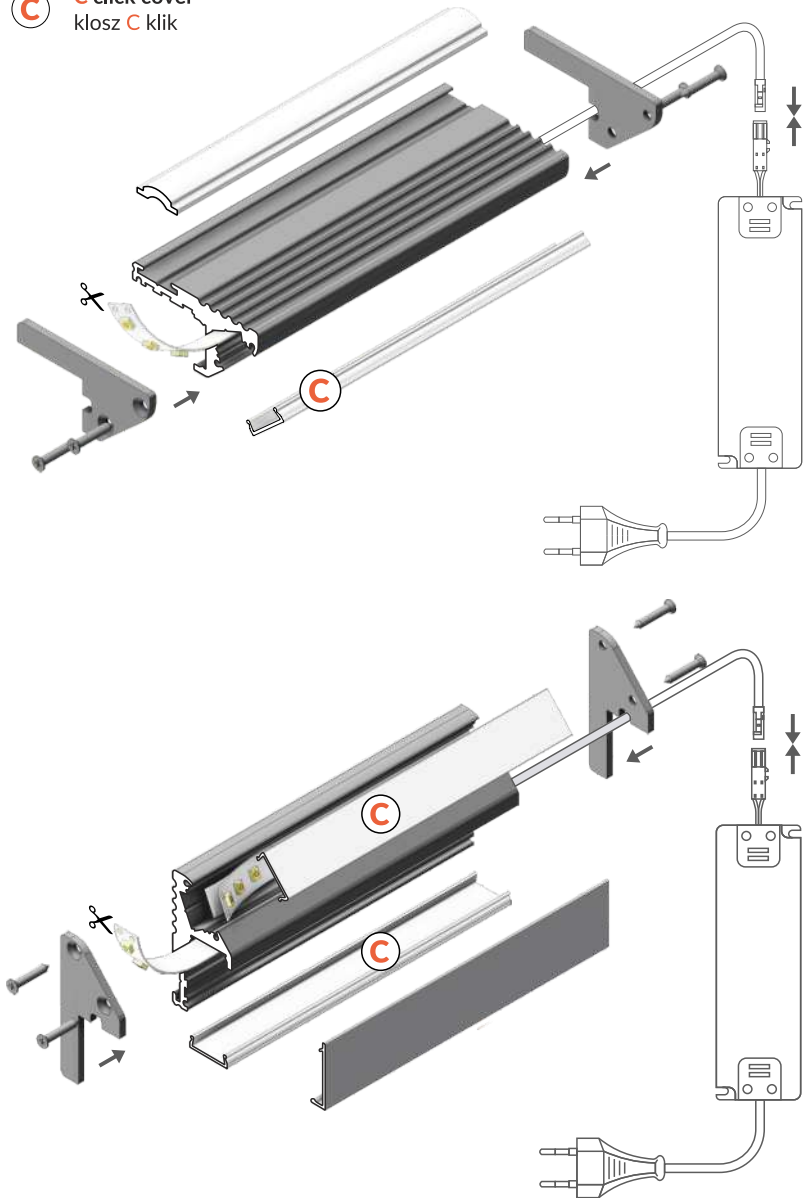
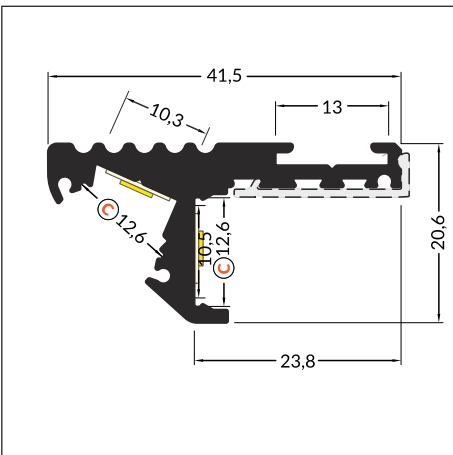
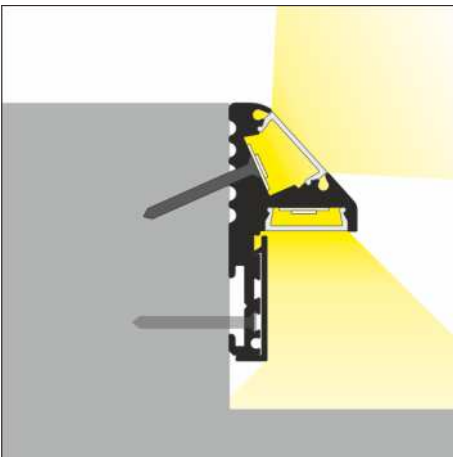
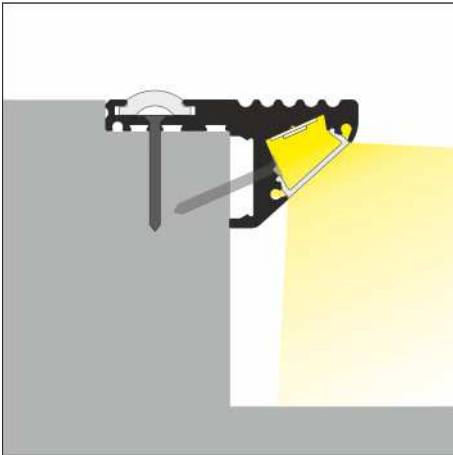

INDEX = 1 pc, length 2000 mm  
package = 10 pcs  
INDEKS = 1 szt., długość 2000 mm  
opakowanie = 10 szt.

 anodized  
anodowany  
32080020

 black anodized  
czarny anodowany  
32080021

Available lengths / Dostępne długości  
1000 mm, 2000 mm, 3000 mm, 4000 mm

 max 10 mm

 special application  
specjalny



## COVERS / KLOSZE

**C click cover**  
colours: transparent, white  
material: PMMA

klosz C klik  
kolory: transparentny, mleczny  
materiał: PMMA



**Note!** Dimensions of the space  
to install LED source  
**Uwaga!** Wymiary przestrzeni  
do zamontowania źródła LED

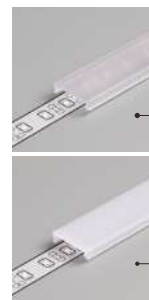
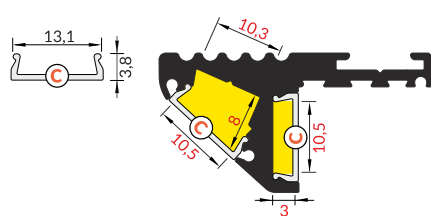

INDEX = 1 pc, length 2000 mm  
package = 10 pcs  
INDEKS = 1 szt., długość 2000 mm  
opakowanie = 10 szt.

C transparent / C transparentny  
76330000

C white / C mleczny  
76330038

## ENDINGS / ZAŚLEPKI

**STEP10 ending**  
colours: silver, black  
material: steel

zaślepka STEP10  
kolory: srebro, czarny  
materiał: stal

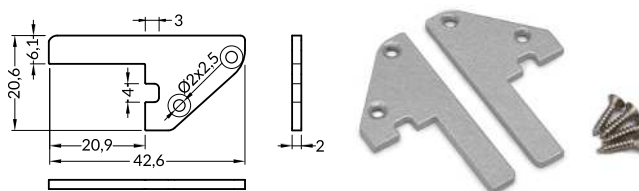

INDEX = 1 set = 2 pcs  
INDEKS = 1 komplet = 2 szt.

silver  
srebro  
32100022

black  
czarny  
32100002

## COVER / OSŁONA

**STEP10 LED cover**  
colours: anodized, black  
material: aluminium

osłona LED STEP10  
kolory: anodowany, czarny  
materiał: aluminium

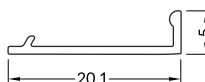

INDEX = 1 pc, length 2000 mm  
package = 10 pcs  
INDEKS = 1 szt., długość 2000 mm  
opakowanie = 10 szt.

anodized  
anodowany  
32120020

black anodized  
czarny anodowany  
32120021

## INSERT / WKŁADKA

**STEP10 anti slip insert**  
colours: transparent, black

wkładka antypoślizgowa STEP10  
kolory: transparentny, czarny



INDEX = 1 pc, length 2000 mm  
package = 10 pcs  
INDEKS = 1 szt., długość 2000 mm  
opakowanie = 10 szt.

transparent  
transparentny  
32150000

black  
czarny  
32150002

**1. Illuminating a step with anti slip insert applied.**

1. Oświetlenie stopnia oraz zastosowanie wkładki antypoślizgowej.



**2. Illuminating a step and edge highlighting.**

2. Oświetlenie stopnia oraz zaakcentowanie krawędzi.



# AMBI12 C

## ALUMINIUM LED PROFILE FOR CREATING LUMINAIRES

### ALUMINIOWY PROFIL LED DO TWORZENIA OPRAW OŚWIETLENIOWYCH

- lighting and decorative profile
- maximum LED strip width: 12 mm
- profil oświetleniowo-dekoracyjny
- maksymalna szerokość taśmy LED: 12 mm



### SIMILAR IN THE OFFER / PODOBNE W OFERCIE







**C** click cover  
klosz C klik

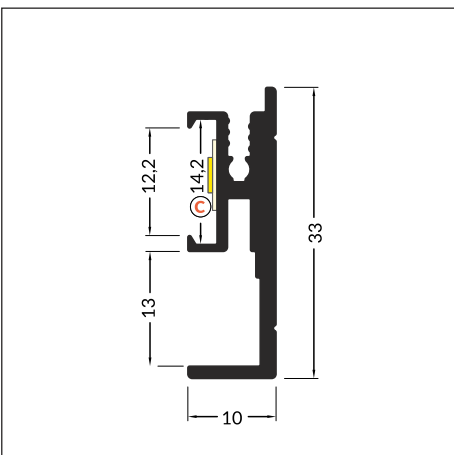
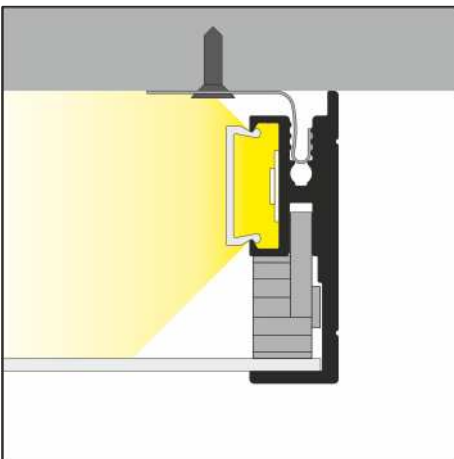
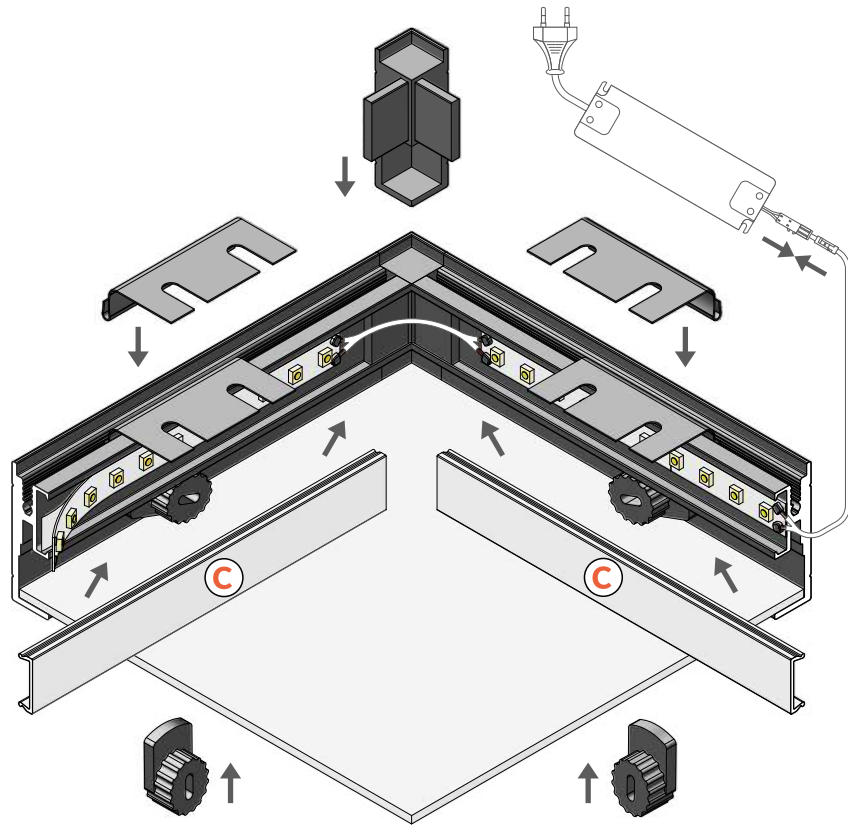

INDEX = 1 pc,  
package = 10 pcs  
INDEKS = 1 szt.,  
opakowanie = 10 szt.

○ white  
biały  
110 mm  
575 mm  
1000 mm  
2000 mm

**B3520001**  
**B3540001**  
**B3500001**  
**B3510001**

● anodized  
anodowany  
110mm  
575 mm  
1000 mm  
2000 mm

**B3520020**  
**B3540020**  
**B3500020**  
**B3510020**

Available lengths / Dostępne długości  
110 mm, 575 mm, 1000 mm, 2000 mm,  
3000 mm, 4000 mm

○ max 12 mm

○ special application  
specjalny



## COVERS / KLOSZE

**C click cover**  
colours: transparent, white  
material: PMMA

klosz C klik  
kolory: transparentny, mleczny  
materiał: PMMA

**AMBI12 cover**  
colour: white  
material: PET

klosz AMBI12  
kolor: mleczny  
materiał: PET

**cover 590x590x1,5**  
colour: white  
material: PS

klosz 590x590x1,5  
kolor: mleczny  
materiał: PS



**Note!** Dimensions of the space to install LED source  
**Uwaga!** Wymiary przestrzeni do zamontowania źródła LED

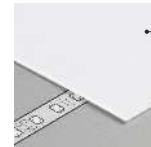
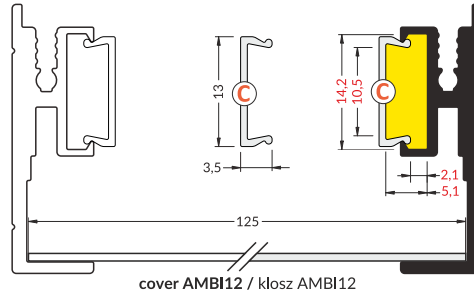

INDEX = 1 pc  
package = 10 pcs  
INDEKS = 1 szt.  
opakowanie = 10 szt.

C transparent / C transparentny

1000 mm 76320000  
2000 mm 76330000

C white / C mleczny

1000 mm 76320038  
2000 mm 76330038

INDEX = 1 pc  
INDEKS = 1 szt.

white cover / klosz mleczny

1010 x 125 mm B3500038  
2010 x 125 mm B3501038  
590 x 590 mm B3503038

## CONNECTOR / ŁĄCZNIK

**AMBI12 L connector**  
colour: white  
material: ABS

łącznik L AMBI12  
kolor: biały  
materiał: ABS

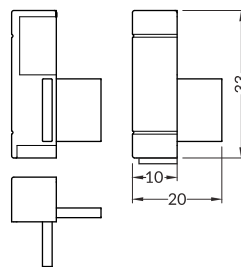

INDEX = 1 set = 4 pcs  
INDEKS = 1 komplet = 4 szt.

white biały B3990001

grey szary B3990022

silver srebrny B3990040

## CLAMP / DOCISK

**AMBI12 clamp**  
colours: white, grey  
material: ABS

docisk AMBI12  
kolory: biały, szary  
materiał: ABS

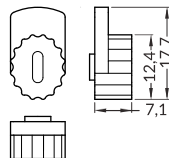

INDEX = 1 set = 4 pcs  
INDEKS = 1 komplet = 4 szt.

white biały B3970001

## MOUNTING / MOCOWANIE

**AMBI12 flexible holder**  
colour: inox  
material: stainless steel

uchwyt AMBI12 sprężysty  
kolor: inox  
materiał: stal nierdzewna

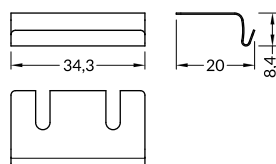

INDEX = 1 set = 4 pcs  
INDEKS = 1 komplet = 4 szt.

inox B3960019

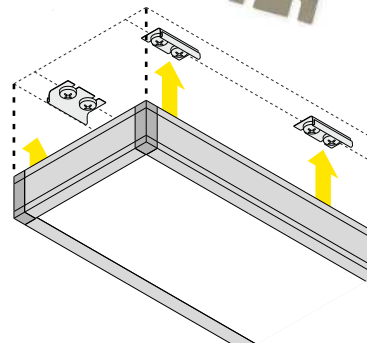
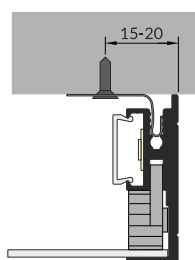



LED profile AMBI12 and dedicated diffusers allows to create decorative luminaires in different dimensions. Depending on the LED strip used, different light effects can be achieved - smooth, edge or more intensive with even lighting surface, that could be strengthened when mounted on a white surface.

Profil LED AMBI12 oraz dedykowane klosze pozwalają na budowanie dekoracyjnych opraw o różnych proporcjach. W zależności od mocy użytej taśmy możliwe jest uzyskanie odmiennych efektów świetlnych: delikatnego, krawędziowego lub intensywniejszego z gładką powierzchnią świecenia, który można dodatkowo wzmocnić montując oprawę na białym podłożu.

# ARC12 CD/U5

## FLEXIBLE ALUMINIUM LED PROFILE

### ALUMINIOWY PROFIL LED DO ZASTOSOWAŃ GIĘTYCH

- flexible aluminium profile - possibility of bending in two directions
- the profile keeps shaped bend
- minimal bending radius: 50 cm
- decorative and illuminating purpose of the profile
- possibility of using two diffusers - better light dispersion
- possible outside installation (with D cover and waterproof LED strip used)
- maximum LED strip width: 12 mm
- aluminiowy profil do zastosowań giętych w dwóch kierunkach jednej płaszczyzny
- profil zachowujący kształt wygięcia
- minimalny promień gięcia: 50 cm
- profil dekoracyjno-oświetleniowy
- możliwość założenia dwóch kloszy - lepsze rozproszenie światła
- możliwość montażu zewnętrznego (przy zastosowaniu klosza D oraz taśmy wodoodpornej)
- maksymalna szerokość taśmy LED: 12 mm



### SIMILAR IN THE OFFER / PODOBNE W OFERCIE

SLIM8  
A/Z

SMART10  
A/Z

BEGTON12  
J/S

UNI12  
BCD/U



- C** C click cover  
klosz C klik
- D** D click cover  
klosz D klik
- U5** cone U5 mounting plate  
uchwyt U5 cone

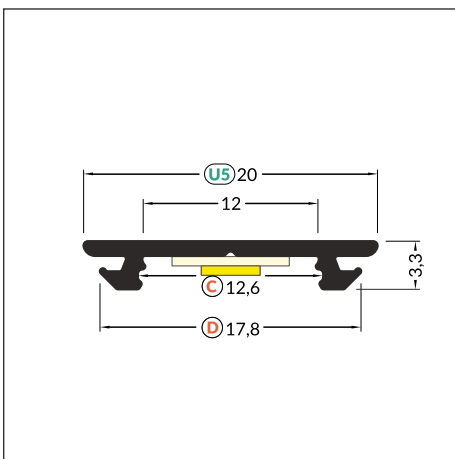
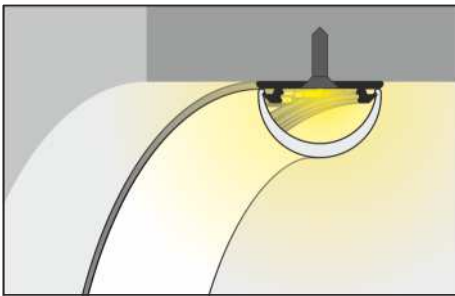
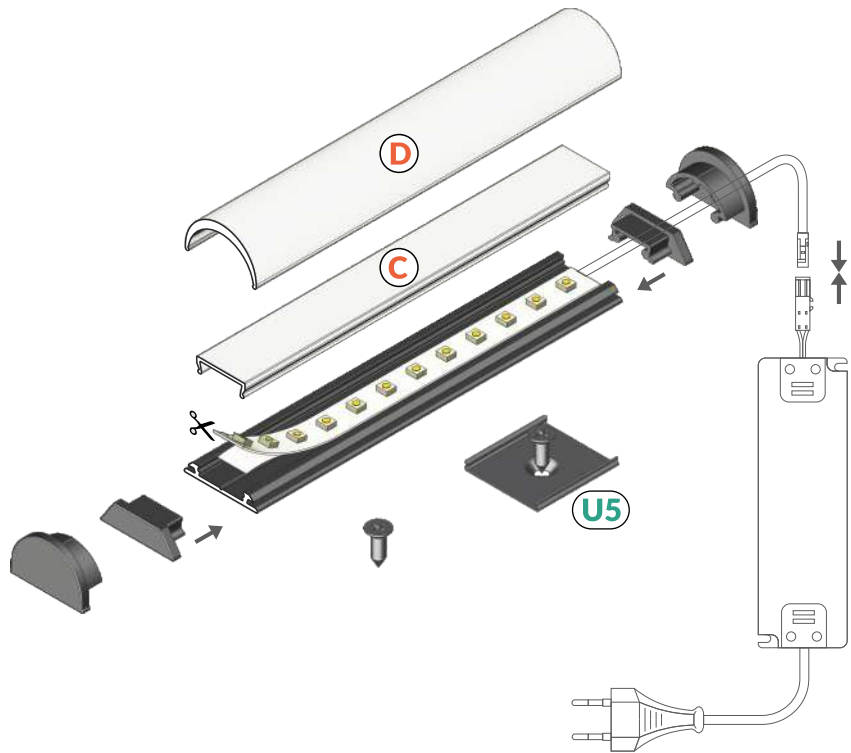

 max 12 mm

 special application  
specjalny



INDEX = 1 pc, length 2000 mm  
package = 10 pcs  
INDEKS = 1 szt., długość 2000 mm  
opakowanie = 10 szt.

 white painted  
biały malowany  
**B2010001**

 anodized  
anodowany  
**B2010020**

 black painted  
czarny malowany  
**B2010002**

 raw aluminium  
surowe aluminium  
**B2010000**

Available lengths / Dostępne długości  
1000 mm, 2000 mm, 3000 mm, 4000 mm



## COVERS / KLOSZE

**C click cover**  
colours: transparent, white  
material: PMMA

klosz **C** klik  
kolory: przezroczysty, mleczny  
materiał: PMMA

**D click cover**  
colour: white  
material: PMMA

klosz **D** klik  
kolor: mleczny  
materiał: PMMA



**Note!** Dimensions of the space to install LED source  
**Uwaga!** Wymiary przestrzeni do zamontowania źródła LED

Maximum LED strip width while using C cover: 10 mm  
Maksymalna szerokość taśmy przy użyciu klosza C: 10 mm

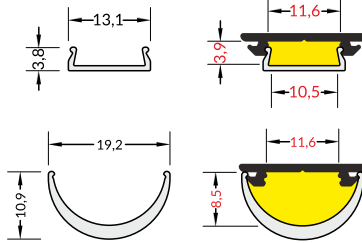

INDEX = 1 pc, length 2000 mm  
package = 10 pcs  
INDEKS = 1 szt., długość 2000 mm  
opakowanie = 10 szt.

**C transparent / C przezroczysty**  
**76330000**

**C white / C mleczny**  
**76330038**

**D white / D mleczny**  
**A1140038**

## ENDINGS / ZAŚLEPKI

**ARC12 ending**  
colours: white, grey, black  
material: ABS

zaślepka ARC12  
kolory: biały, szary, czarny  
materiał: ABS

**ARC12 D ending**  
colours: white, grey, black  
material: ABS

zaślepka ARC12 D  
kolory: biały, szary, czarny  
materiał: ABS



Ending with marked space to bore the holes.  
Zaślepka z punktami do przewiercenia otworów.

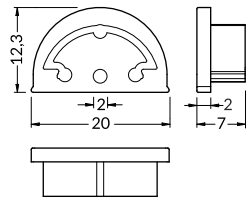
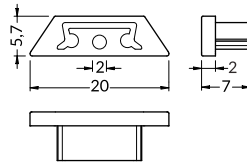

INDEX = 1 set, package of 10 sets = 20 pcs  
INDEKS = 1 komplet  
opakowanie zawiera 10 kpl = 20 szt

ARC12 ending / zaślepka ARC12

- white biały **B2960001**
- grey szary **B2960022**
- black czarny **B2960002**
- silver srebro **B2960040**

ARC12 D ending / zaślepka ARC12 D

- white biały **B2980001**
- grey szary **B2980022**
- black czarny **B2980002**
- silver srebro **B2980040**

## MOUNTINGS / MOCOWANIA

**cone U5 mounting plate**  
colour: inox  
material: stainless steel

uchwyt **U5** cone  
kolor: inox  
materiał: stal nierdzewna

**side U5 mounting plate**  
colours: white, silver, black  
material: stainless steel, aluminium

uchwyt **U5** boczny  
kolory: biały, srebro, czarny  
materiał: stal nierdzewna, aluminium

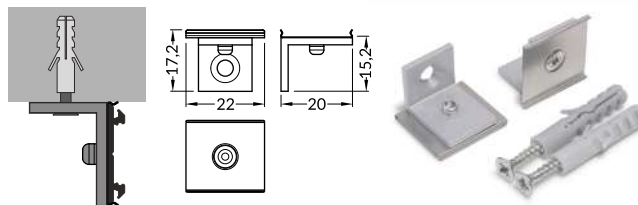
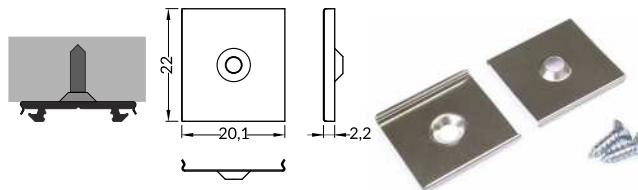

INDEX = 1 set  
package of 10 sets = 20 pcs  
INDEKS = 1 komplet  
opakowanie zawiera 10 kpl = 20 szt

cone **U5** mounting plate  
uchwyt **U5** cone

- inox inox **B2940019**

side **U5** mounting plate  
uchwyt **U5** boczny

- white biały **B2920001**
- silver srebro **B2920022**
- black czarny **B2920002**

## SLING / ZAWIESIE

**SELV sling 50 V 1500**  
colour: white, silver, black

zawiesie SELV 50 V 1500  
kolor: biały, srebro, czarny

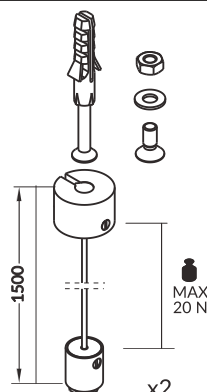

INDEX = 1 set  
INDEKS = 1 zestaw

SELV sling 50 V 1500  
zawiesie SELV 50 V 1500

- white biały **67120001**
- silver srebro **67120022**
- black czarny **67120002**



# FIX12 / FIX16



## THE SIMPLEST INSTALLATION OF A LED STRIP

### NAJPROSTSZE MOCOWANIE TAŚMY LED

- function of radiator
- improves LED strip's adhesion
- minimal height of the profile
- budget profile, to be used without a cover
- maximum width of LED strip: 12 mm (FIX12) and 16 mm (FIX16)
- it can also function as a mounting profile:  
FIX12 for profiles with X socket  
FIX16 for profiles with T socket

- funkcja radiatora
- trwalsze przyleganie taśmy LED
- minimalna wysokość profilu
- profil budżetowy, do użycia bez klosza
- maksymalna szerokość taśmy LED: 12 mm (FIX12) oraz 16 mm (FIX16)
- może pełnić również funkcję montażową:  
FIX12 dla profili z gniazdem X  
FIX16 dla profili z gniazdem T



## SIMILAR IN THE OFFER / PODOBNE W OFERCIE

  
SLIM8  
A/Z

  
SMART10  
A/Z

  
SURFACE10  
BC/UX

  
BEGTON12  
J/S

  
ARC12  
CD/R

  
SURFACE14  
EF/TY



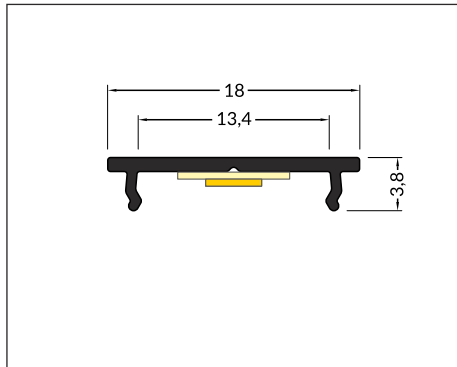
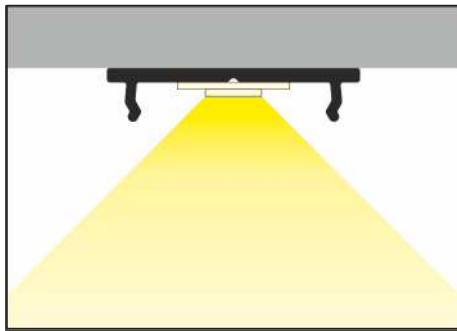

max 12 mm



special application  
specjalny



mounting with screws  
or adhesive tape  
montaż na wkręty  
albo taśmę dwustronną



INDEX = 1 pc, length 2000 mm  
package = 10 pcs  
INDEKS = 1 szt., długość 2000 mm  
opakowanie = 10 szt.



anodized  
anodowany  
87030020



raw aluminium  
surowe aluminium  
87030000

Available lengths / Dostępne długości  
1000 mm, 2000 mm, 3000 mm, 4000 mm

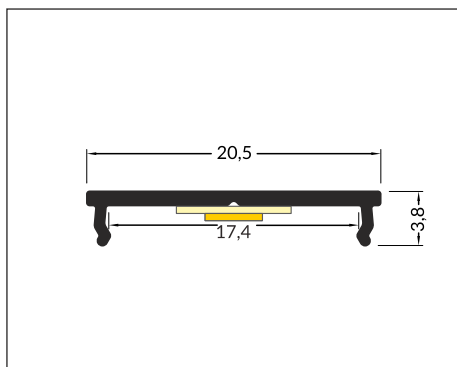
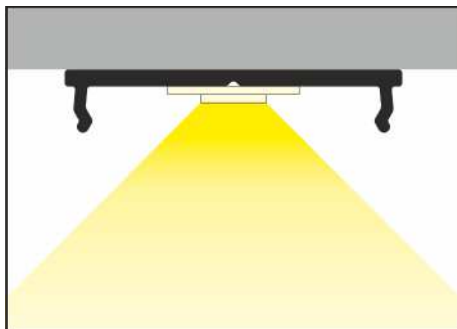

max 16 mm



special application  
specjalny



mounting with screws  
or adhesive tape  
montaż na wkręty  
albo taśmę dwustronną



INDEX = 1 pc, length 2000 mm  
package = 10 pcs  
INDEKS = 1 szt., długość 2000 mm  
opakowanie = 10 szt.



white painted  
biały malowany  
C6020001



anodized  
anodowany  
C6020020



black anodized  
czarny anodowany  
C6020021



raw aluminium  
surowe aluminium  
C6020000

Available lengths / Dostępne długości  
1000 mm, 2000 mm, 3000 mm, 4000 mm

# OUTSTAIRS12 BC

## BRASS PROFILE TO ILLUMINATE THE EDGE OF A STAIR STEPS

### PROFIL MOSIĘŻNY DO OŚWIETLANIA KRAWĘDZI STOPNI

- decorative and lighting profile
- high resistance to weather conditions
- in high humidity conditions we recommend using IP65 LED strip
- maximum LED strip width: 12 mm
- profil dekoracyjno-oświetleniowy
- wysoka odporność na warunki atmosferyczne
- przy podwyższonej wilgotności stosować taśmę IP65
- maksymalna szerokość taśmy LED: 12 mm



## SIMILAR IN THE OFFER / PODOBNE W OFERCIE



STEP10  
C



FLOOR12  
K/U



**B** slide cover  
klosz B wsuwany

**C** click cover  
klosz C klik

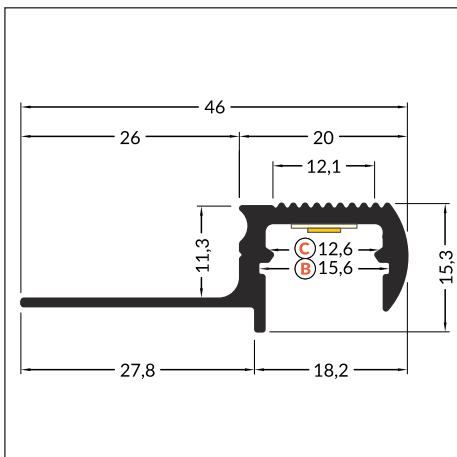
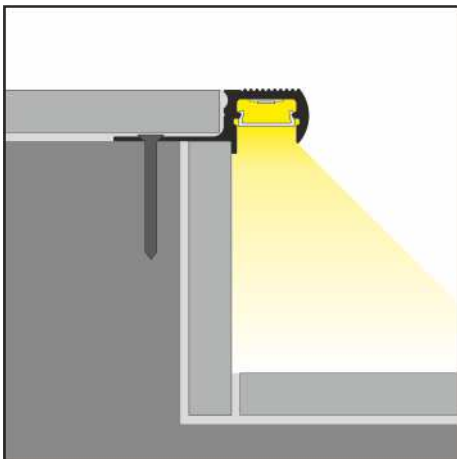
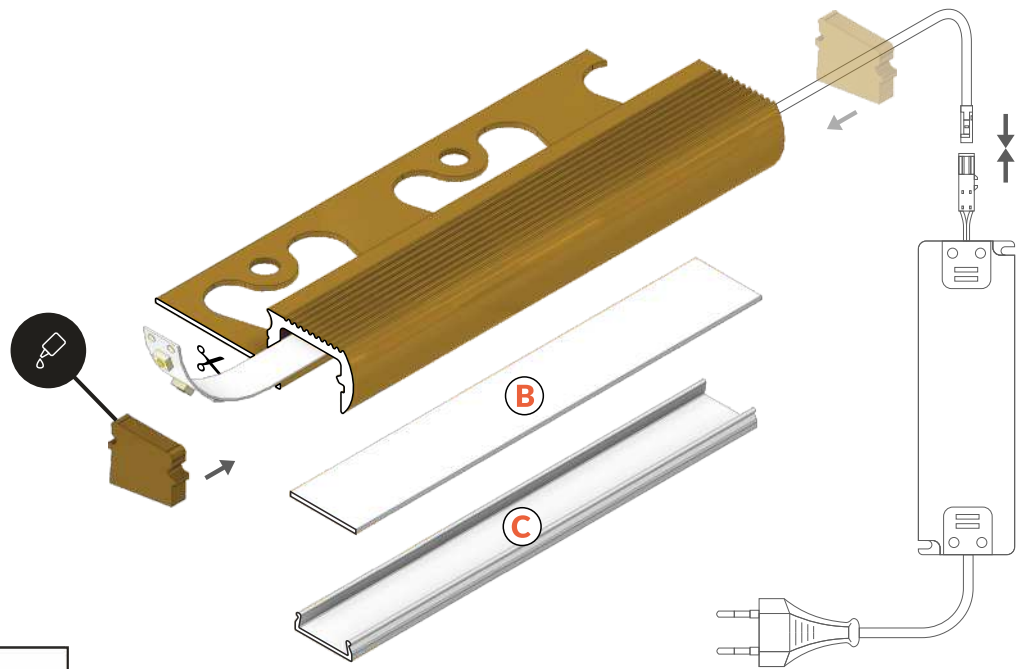

 max 12 mm

 special application  
specjalny

INDEX = 1 pc, length 1600 mm  
INDEKS = 1 szt., długość 1600 mm

 brass  
mosiądz  
B9020005s

Available lengths / Dostępne długości  
1100 mm, 1600 mm





## COVERS / KLOSZE

**B slide cover**  
colours: transparent, frosted, white  
material: PC, PP, PP

klosz B wsuwany  
kolory: transparentny, szron, mleczny  
materiał: PC, PP, PP



**Note!** Dimensions of the space to install LED source  
**Uwaga!** Wymiary przestrzeni do zamontowania źródła LED

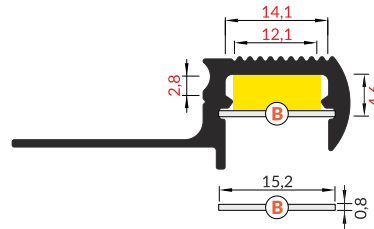

**C click cover**  
colours: transparent, white  
material: PMMA

klosz C klik  
kolory: transparentny, mleczny  
materiał: PMMA

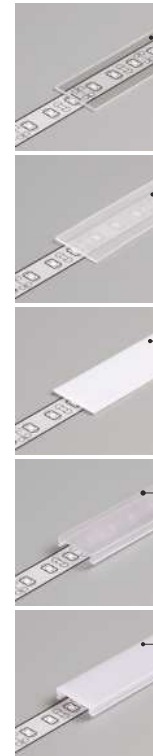
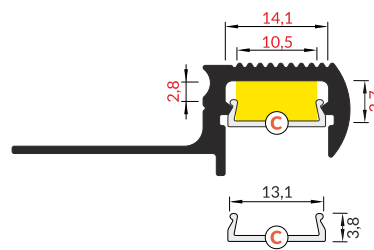

INDEX = 1 pc, length 2000 mm  
package = 10 pcs  
INDEKS = 1 szt., długość 2000 mm  
opakowanie = 10 szt.

B transparent / B transparentny  
76250016

B frosted / B szron  
76250039

B white / B mleczny  
76250038

C transparent / C transparentny  
76330000

C white / C mleczny  
76330038

## ENDINGS / ZAŚLEPKI

**OUTSTAIRS12 ending**  
colour: brass  
material: brass

zaślepka OUTSTAIRS12  
kolor: miedz  
materiał: miedz

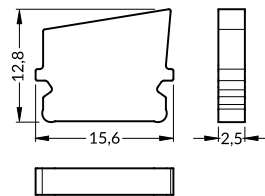

Endings mounted on assembly adhesive  
Zaślepki mocowane na klej montażowy

INDEX = 1 set  
INDEKS = 1 komplet

brass  
miedz  
B9990005

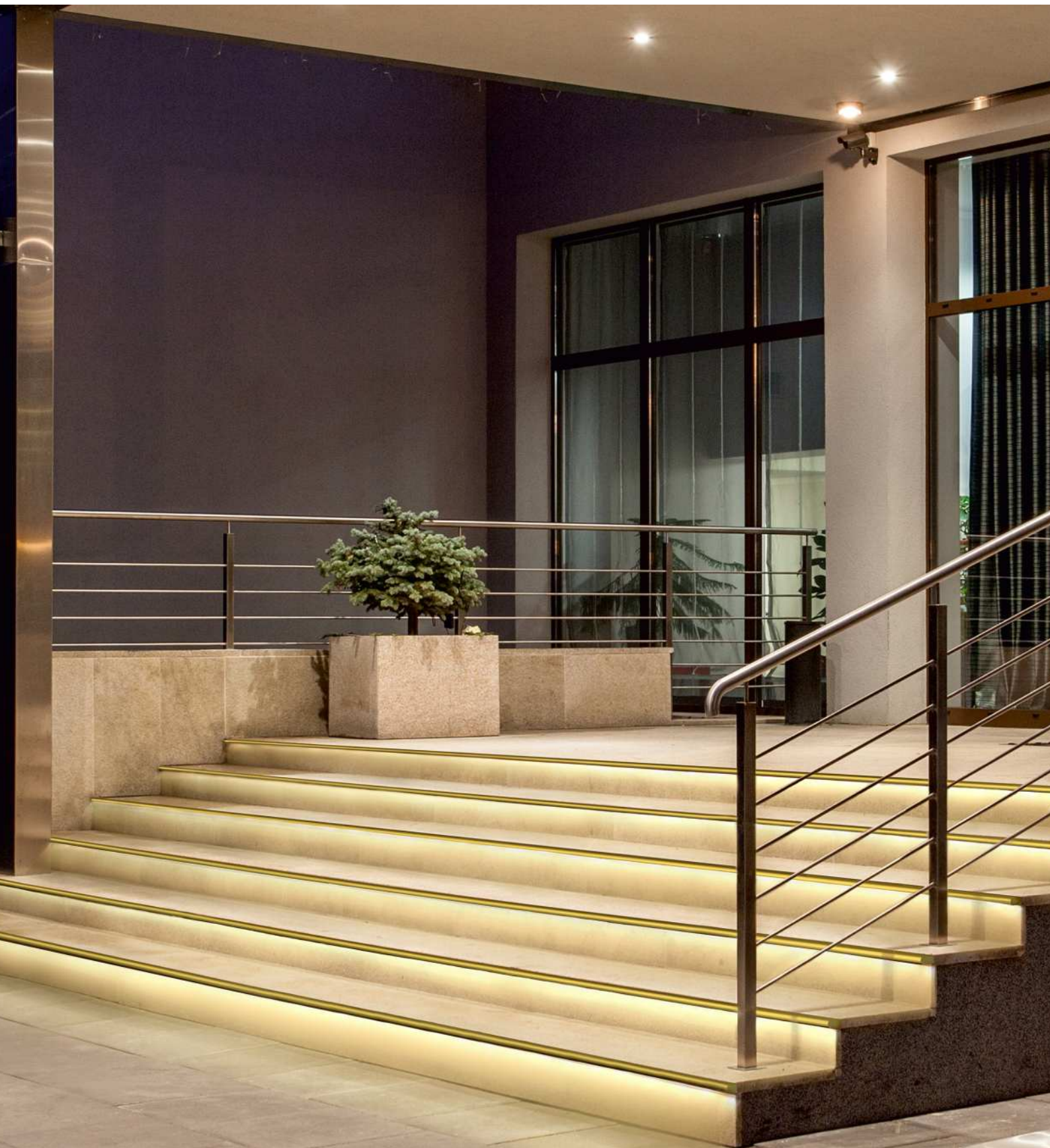

# WALLE12 BCD

## WALL-MOUNTED PROFILE

### PROFIL DO MONTAŻU ŚCIENNEGO

- decorative and lighting profile
- mounted directly to a wall or ceiling
- 6 types of matching covers
- possibility of outdoor using (with D cover and waterproof LED strip)
- maximum LED strip width: 12 mm
- profil dekoracyjno-oświetleniowy
- montowany bezpośrednio do ściany lub sufitu
- 6 rodzajów pasujących kloszy
- możliwość zastosowania zewnętrznego (przy użyciu klosza D i taśmy wodoodpornej)
- maksymalna szerokość taśmy LED: 12 mm



### SIMILAR IN THE OFFER / PODOBNE W OFERCIE

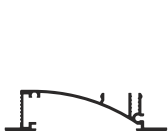

FLAT8  
H/UX



BACK10  
A/UX



AMBI12  
C

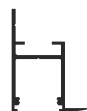

FRAME14  
BC/Q



**B** slide cover  
klosz B wsuwany

**C** click cover  
klosz C klik

**D** click cover  
klosz D klik

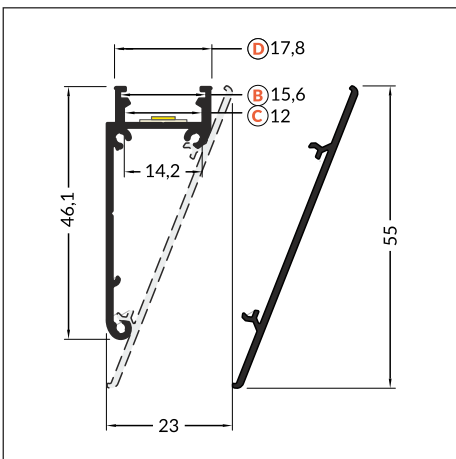
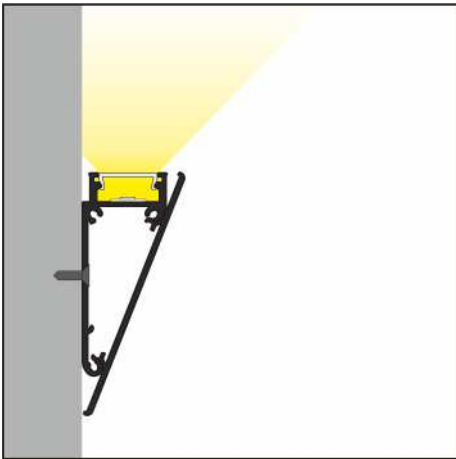
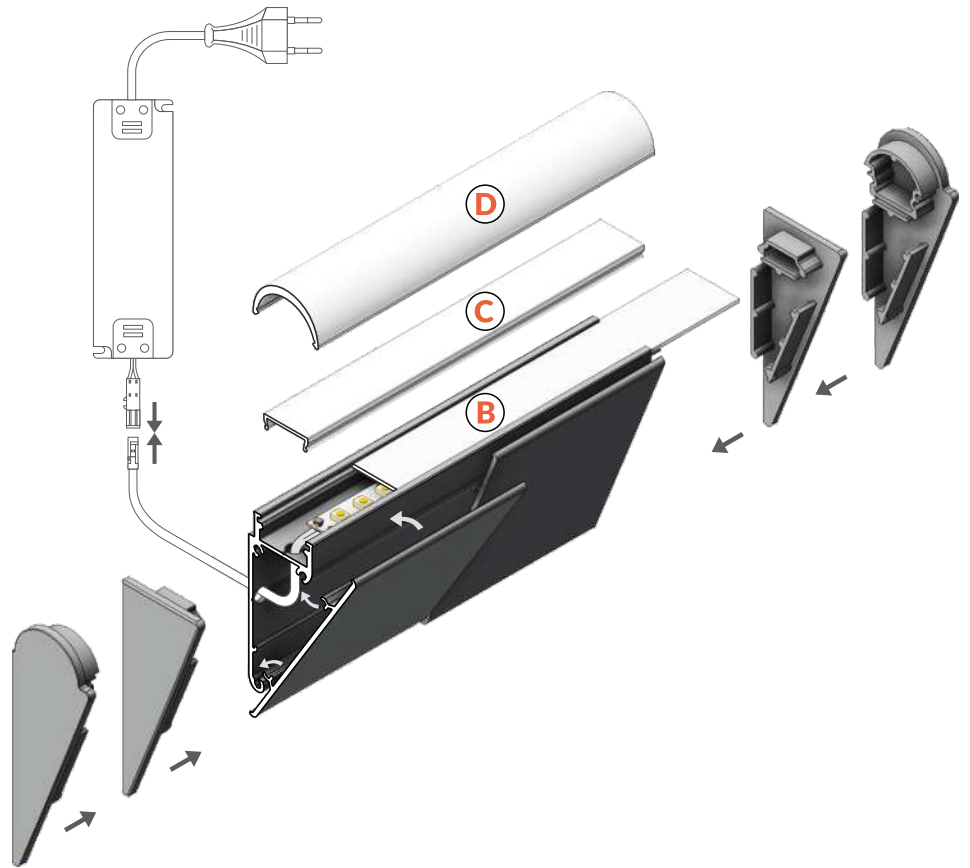

max 12 mm



special application  
specjalny

INDEX = 1 pc, length 2000 mm  
package = 10 pcs  
INDEKS = 1 szt., długość 2000 mm  
opakowanie = 10 szt.

 white painted  
biały malowany  
**B8060001**

 anodized  
anodowany  
**B8020020**

 raw aluminium  
surowe aluminium  
**C6020000**



Available lengths / Dostępne długości  
1000 mm, 2000 mm, 3000 mm, 4000 mm



## COVERS / KLOSZE

**B slide cover**  
colours: transparent, frosted, white  
material: PC, PP, PP

klosz **B** wsuwany  
kolory: transparentny, szron, mleczny  
materiał: PC, PP, PP

**C click cover**  
colours: transparent, white  
material: PMMA

klosz **C** klik  
kolory: transparentny, mleczny  
materiał: PMMA

**D click cover**  
colour: transparent  
material: PMMA

klosz **D** klik  
kolor: transparentny  
materiał: PMMA



**Note!**  
Dimensions of the space  
to install LED source  
**Uwaga!**  
Wymiary przestrzeni  
do zamontowania  
źródła LED

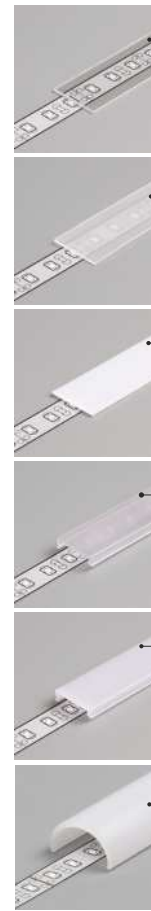
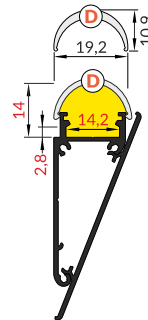
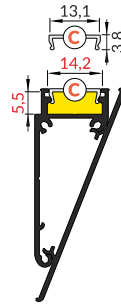
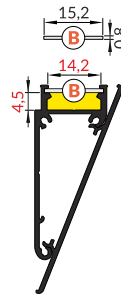

INDEX = 1 pc, length 2000 mm  
package = 10 pcs  
INDEKS = 1 szt., długość 2000 mm  
opakowanie = 10 szt.

**B transparent / B transparentny**  
76250016

**B frosted / B szron**  
76250039

**B white / B mleczny**  
76250038

**C transparent / C transparentny**  
76330000

**C white / C mleczny**  
76330038

**D white / D mleczny**  
A1140038

## ENDINGS / ZAŚLEPKI

**WALLE12 ending**  
colours: white, silver, grey  
material: ABS

zaślepka WALLE12  
kolory: biały, srebrny, szary  
materiał: ABS

**WALLE12 D ending**  
colours: white, silver, grey  
material: ABS

zaślepka WALLE12 D  
kolory: biały, srebrny, szary  
materiał: ABS

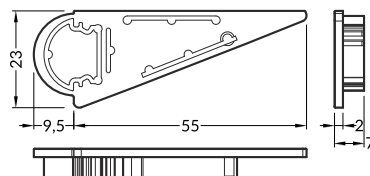
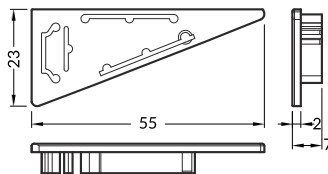

INDEX = 1 set  
package of 10 sets = 20 pcs  
INDEKS = 1 komplet  
opakowanie zawiera 10 kpl = 20 szt

WALLE12 ending  
zaślepka WALLE12

white biały **B8900001**  
 silver srebro **B8900040**  
 grey szary **B8900022**

WALLE12 D ending  
zaślepka WALLE12 D

white biały **B8890001**  
 silver srebro **B8890040**  
 grey szary **B8890022**

## COVER / OSŁONA

**WALLE12 cover**  
colours: white, anodized  
material: aluminium

osłona WALLE12  
kolory: biały, anodowany  
materiał: aluminium



INDEX = 1 pc, length 2000 mm  
package = 10 pcs  
INDEKS = 1 szt., długość 2000 mm  
opakowanie = 10 szt.

white painted biały malowany **B8080001**  
 anodized anodowany **B8040020**





## CONNECTORS / ŁĄCZNIKI

### WALLE12 straight connector

colour: inox

material: stainless steel

łącznik WALLE12 prosty

kolor: inox

materiał: stal nierdzewna

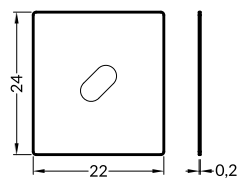

### WALLE12 connector 90 deg

colours: white, anodized

material: aluminium

łącznik WALLE12 90 st

kolor: biały, anodowany

materiał: aluminium

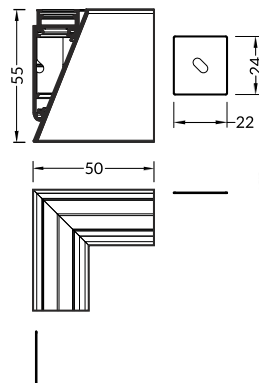

INDEX for 1 set  
INDEKS dla 1 kompletu



inox  
inox

B8950019



white painted  
biały malowany

B8910001



anodized  
anodowany

B8910020



# FRAME14 BC/Q

## ALUMINIUM LED PROFILE FOR PLASTERBOARD

### ALUMINIOWY PROFIL LED DO PŁYT KARTONOWO-GIPSOWYCH

- decorative and lighting profile
- dedicated for plasterboards - decorative construction finish
- continuous line of light (when using LED strip 120 P/m and white cover)
- multiple arrangements through a variety of connectors
- maximum LED strip width: 14 mm
- profil dekoracyjno-oświetleniowy
- dedykowany do płyt kartonowo-gipsowych - dekoracyjne wykończenie konstrukcji
- ciągła linia światła (przy zastosowaniu taśmy 120 P/m i klosza mlecznego)
- wiele możliwości aranżacyjnych dzięki różnorodnym łącznikom
- maksymalna szerokość taśmy LED: 14 mm



### SIMILAR IN THE OFFER / PODOBNE W OFERCIE



FLAT8  
H/UX



DEEP10  
BC/UX



WALLE12  
CD



**B** slide cover  
klosz B wsuwany

**C** click cover  
klosz C klik

**Q** connector  
łącznik Q

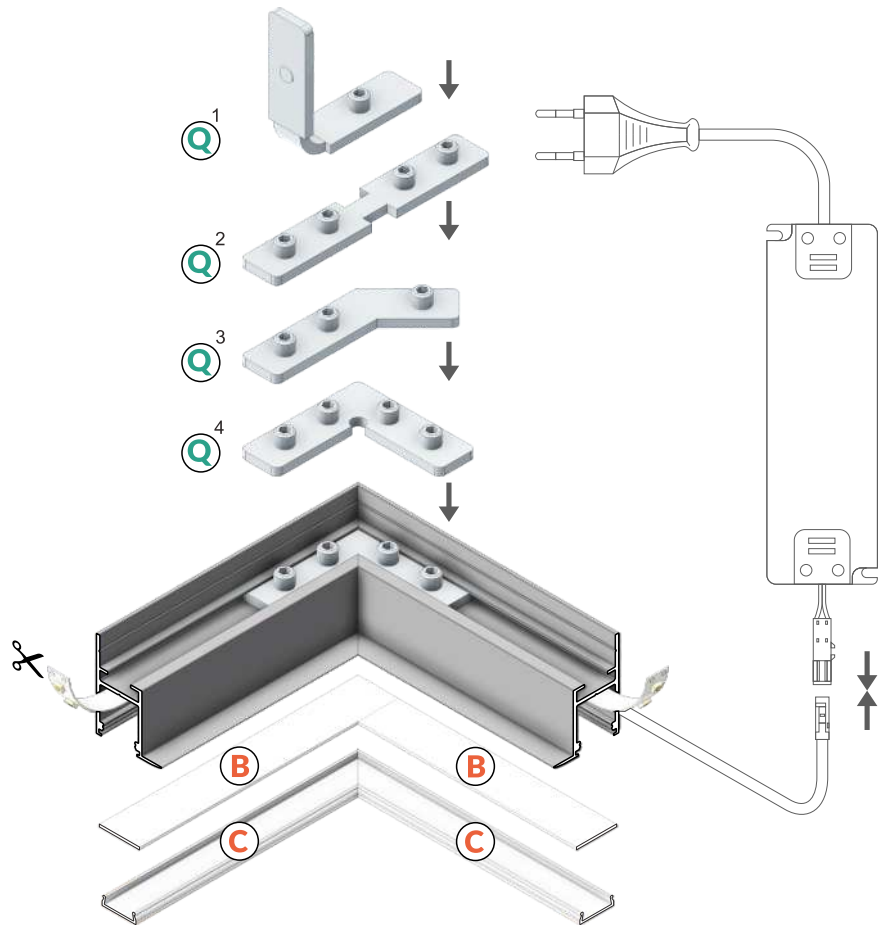
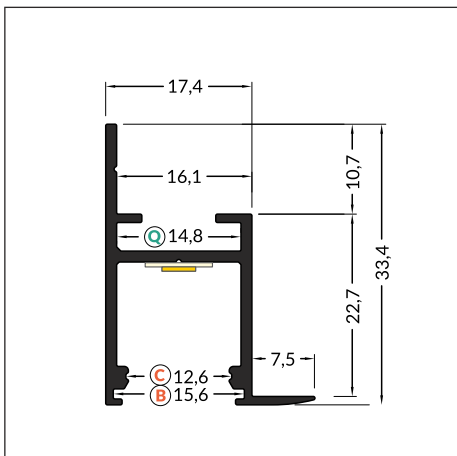
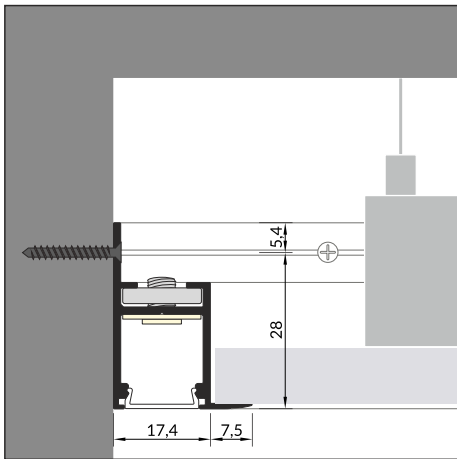
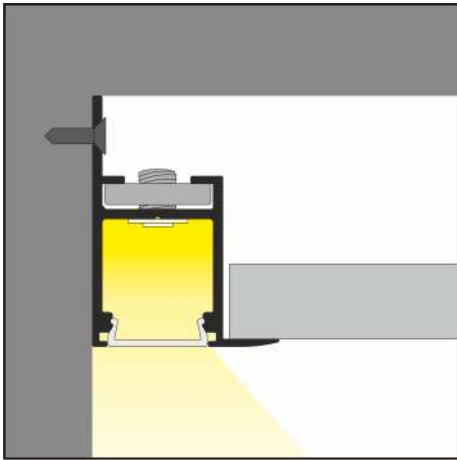

Please note! The profile isn't a construction profile.  
Uwaga. Profil nie pełni funkcji konstrukcyjnej.

 max 14 mm

 special application  
specjalny



INDEX = 1 pc, length 2000 mm  
package = 10 pcs  
INDEKS = 1 szt., długość 2000 mm  
opakowanie = 10 szt.

 white painted  
biały malowany  
C3020001

 anodized  
anodowany  
C3020020

 raw aluminium  
surowe aluminium  
C3020000

Available lengths / Dostępne długości  
1000 mm, 2000 mm, 3000 mm, 4000 mm



## COVERS / KLOSZE

### B slide cover

colours: transparent, frosted, white  
material: PC, PP, PP

klosz B wsuwany  
kolory: transparentny, szron, mleczny  
materiał: PC, PP, PP



**Note!**  
Dimensions of the space  
to install LED source  
**Uwaga!**  
Wymiary przestrzeni  
do zamontowania  
źródła LED

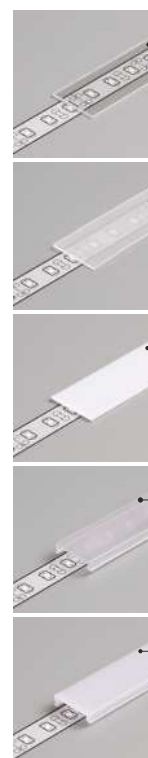
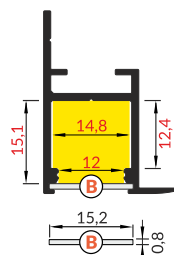

INDEX = 1 pc, length 2000 mm  
package = 10 pcs  
INDEKS = 1 szt., długość 2000 mm  
opakowanie = 10 szt.

B transparent / B transparentny  
76250016

B frosted / B szron  
76250039

B white / B mleczny  
76250038

C transparent / C transparentny  
76330000

C white / C mleczny  
76330038

### C click cover

colours: transparent, white  
material: PMMA

klosz C klik  
kolory: transparentny, mleczny  
materiał: PMMA

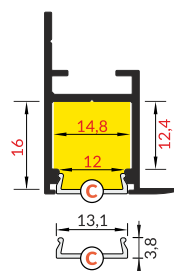

## CONNECTORS / ŁĄCZNIKI

### Q 180 deg / 135 deg / 90 deg connector

material: zinc coated

łącznik Q 180 st / 135 st / 90 st  
materiał: stal ocynkowana

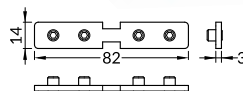

INDEX = 1 pc  
INDEKS = 1 szt

Q 180 deg connector  
łącznik Q 180 st  
C3990030

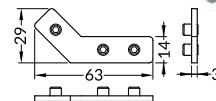

Q 135 deg connector  
łącznik Q 135 st  
C3980030

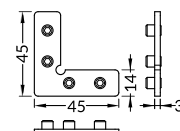

Q 90 deg connector  
łącznik Q 90 st  
C3970030

### Q 90 deg bent connector

material: zinc coated

łącznik Q 90 st gięty  
materiał: stal ocynkowana

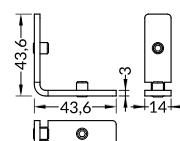

Q 90 deg bent connector  
łącznik Q 90 st gięty  
C3960030



# OVAL20 BC

## A DOUBLE-FUNCTION BAR FOR WARDROBES

### DWUFUNKCYJNY DRAŻEK DO SZAF GARDEROBIANYCH

- decorative and lighting profile
  - a bar for hanging garments and illuminating the wardrobe
  - 3 mounting options: side-to-side, as an extension arm from a side, as an extension arm from the top
  - two LED strip installation depths to choose from
  - maximum LED strip width: 20 mm
- 
- profil oświetleniowo-dekoracyjny
  - drążek do wieszania ubrań i oświetlania szafy
  - 3 opcje montażu: od ścianki do ścianki, jako wysięgnik ze ściany, jako wysięgnik z sufitu
  - do wyboru dwie głębokości osadzenia taśmy LED
  - maksymalna szerokość taśmy LED: 20 mm

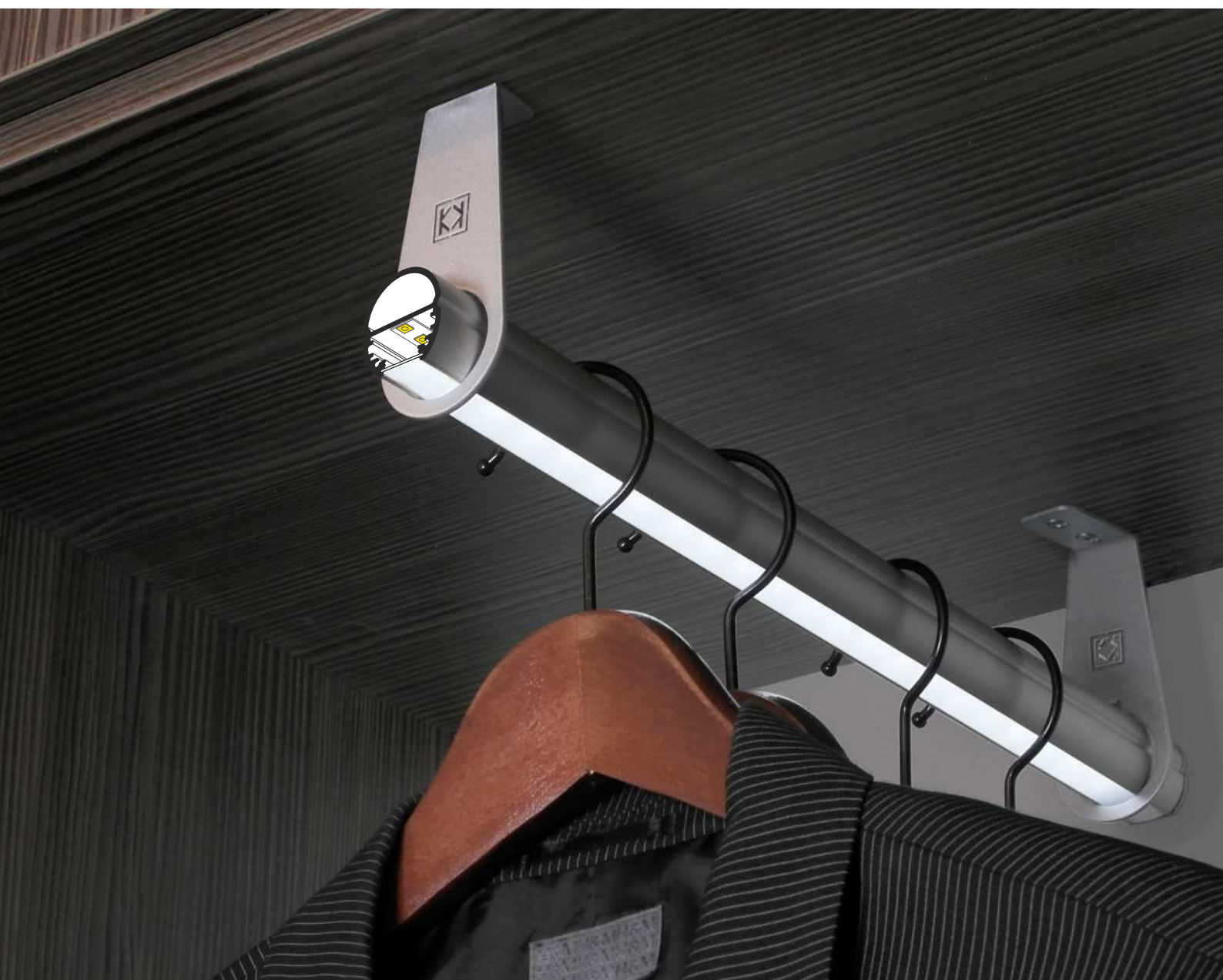

## SIMILAR IN THE OFFER / PODOBNE W OFERCIE



**B** slide cover  
klosz B wsuwany

**C** click cover  
klosz C klik

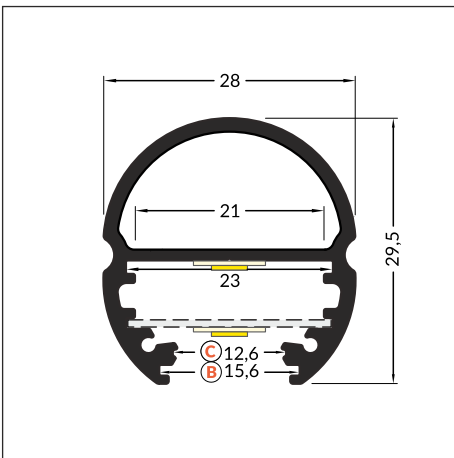
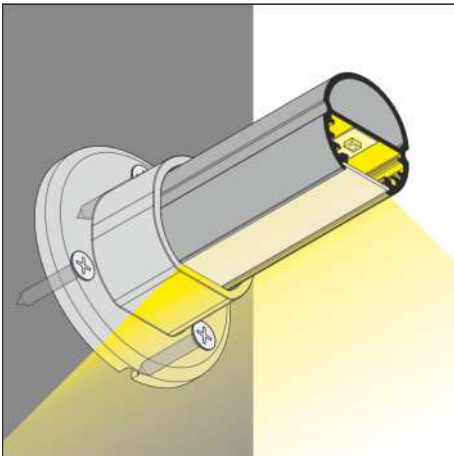
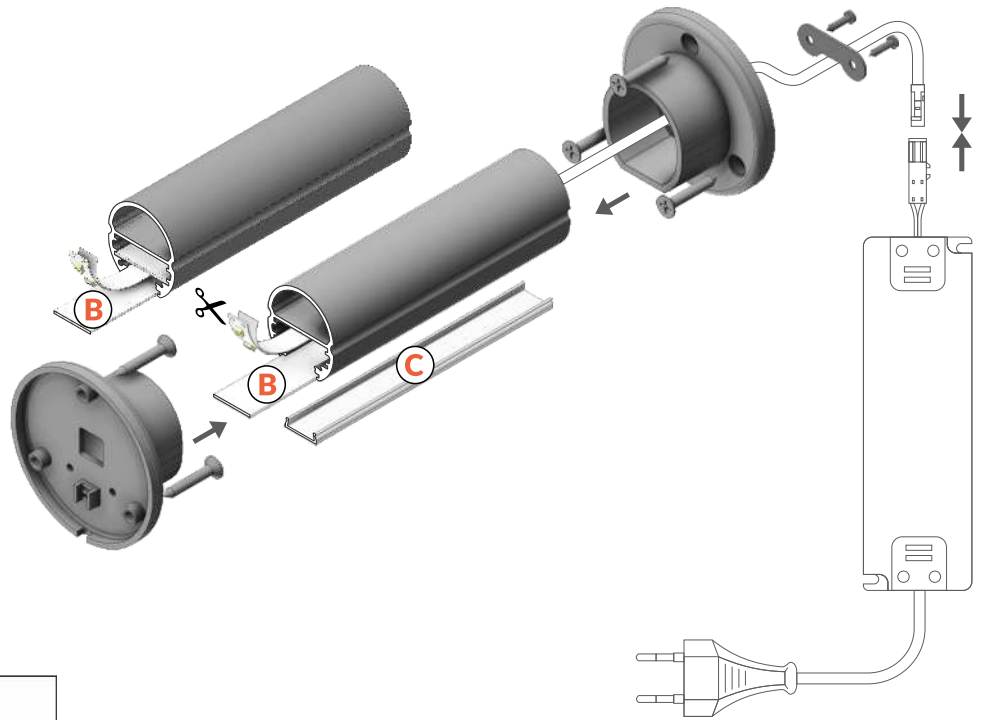

 max 20 mm

 special application  
specjalny

INDEX = 1 pc, length 2000 mm  
package = 10 pcs  
INDEKS = 1 szt., długość 2000 mm  
opakowanie = 10 szt.

 anodized  
anodowany  
92030020

Available lengths / Dostępne długości  
1000 mm, 2000 mm, 3000 mm, 4000 mm



## COVERS / KLOSZE

### B slide cover

colours: transparent, frosted, white  
material: PC, PP, PP

klosz B wsuwany  
kolory: transparentny, szron, mleczny  
materiał: PC, PP, PP



**Note!** Dimensions of the space to install LED source  
**Uwaga!** Wymiary przestrzeni do zamontowania źródła LED

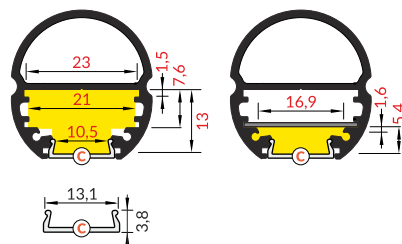
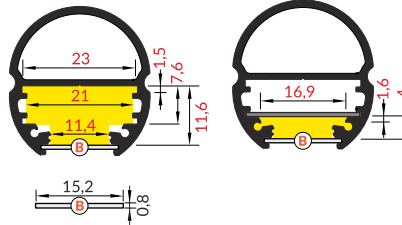

INDEX = 1 pc, length 2000 mm  
package = 10 pcs  
INDEKS = 1 szt., długość 2000 mm  
opakowanie = 10 szt.

B transparent / B transparentny  
76250016

B frosted / B szron  
76250039

B white / B mleczny  
76250038

C transparent / C transparentny  
76330000

C white / C mleczny  
76330038

## MOUNTINGS / MOCOWANIA

### OVAL20 side holder

colours: silver, grey  
material: ABS

uchwyt OVAL20 boczny  
kolory: srebrny, szary  
materiał: ABS

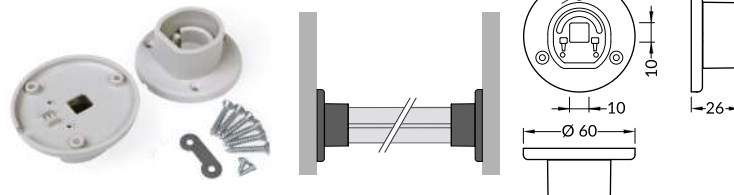

INDEX = 1 set  
INDEKS = 1 komplet

OVAL20 side holder  
uchwyt OVAL20 boczny

silver srebrny 92040040

grey szary 92040022

### OVAL20 single extension arm

colour: silver  
material: ABS, steel, aluminium

wysięgnik OVAL20 pojedynczy  
kolor: srebrny  
materiał: ABS, stal, aluminium

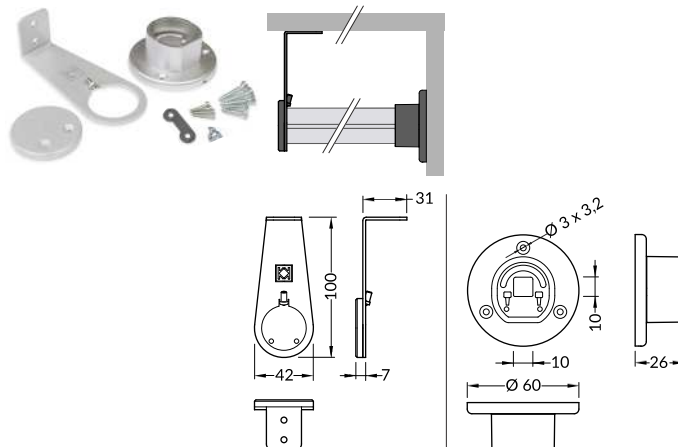

single extension arm  
wysięgnik pojedynczy

silver srebrny 92980040

### OVAL20 double extension arm

colour: silver  
material: ABS, steel, aluminium

wysięgnik OVAL20 podwójny  
kolor: srebrny  
materiał: ABS, stal, aluminium

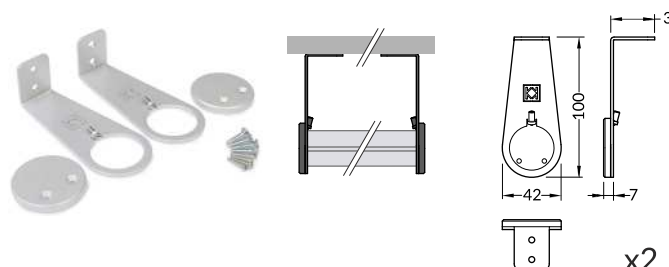

double extension arm  
wysięgnik podwójny

silver srebrny 92990040





## MOUNTINGS / MOCOWANIA

**OVAL20 simple holder**  
material: zinc coated steel

uchwyt OVAL20 prosty  
materiał: stal ocynkowana

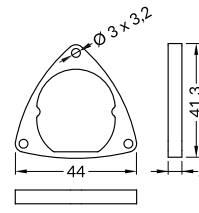
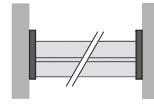

INDEX = 1 set  
INDEKS = 1 komplet

OVAL20 simple holder  
uchwyt OVAL20 prosty



zinc coated  
stal ocynkowana  
92070030

## LED MOUNTING / MOCOWANIE LED

**OVAL20 LED mounting**  
material: aluminium

mocowanie LED OVAL20  
materiał: aluminium

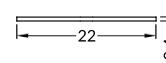

INDEX for 2000 mm length  
INDEKS dla długości 2000 mm



raw aluminium  
surowe aluminium  
92100000







**GLASS APPLICATION  
DO SZKŁA**

**2017**

**LED profiles  
profile LED**

# TWIN8

## A TWO-WAY EDGE PROFILE FOR GLASS SHELVES

### DWUKIERUNKOWY PROFIL KRAWĘDZIOWY DO SZKLANYCH PÓŁEK

- decorative and lighting profile
- mounted on the glass or shelf rear edge
- 2 lighting directions: up and down
- illuminating the rear side of a display case
- additionally illumination of the glass edge with the TWIN8 PLUS profile
- fits the 8 mm thick glass panel
- when using on a thinner glass, consider additional adhesive tape
- note: the profile is not a construction element
- maximum LED strip width: 8 mm
- profil dekoracyjno-oświetleniowy
- montaż do tylnej krawędzi szyby, półki
- 2 kierunki świecenia: góra i dół
- oświetla wewnętrzną ścianę witryny
- dodatkowo podświetlenie krawędzi szyby w wersji TWIN8 PLUS
- do szyby o grubości 8 mm
- możliwość zastosowania do cieńszej szyby - należy przewidzieć dodatkowe klejenie taśmą
- uwaga: profil nie jest elementem konstrukcyjnym
- maksymalna szerokość taśmy LED: 8 mm

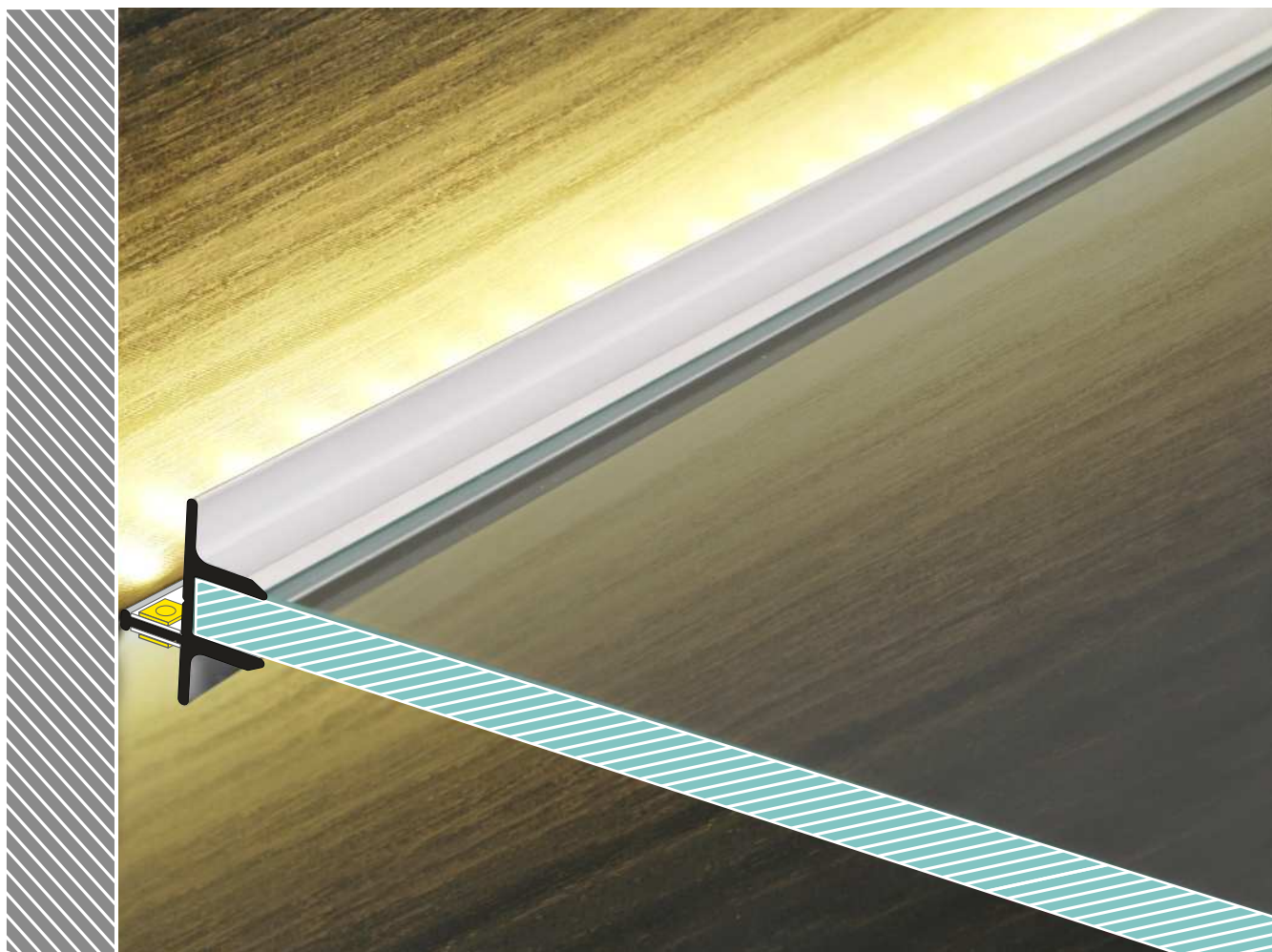

### SIMILAR IN THE OFFER / PODOBNE W OFERCIE



BACK10  
A/UX



EDGE10  
BC



MIKRO10



MIKRO-LINE12



CABI12  
E

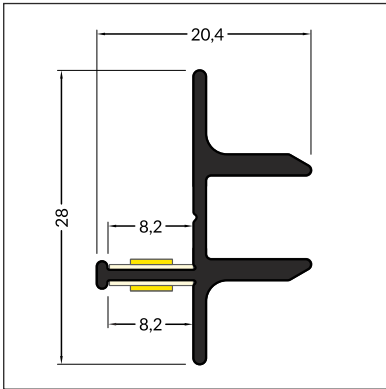

max 8 mm



glass application  
do szkła

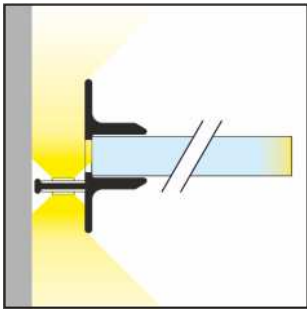
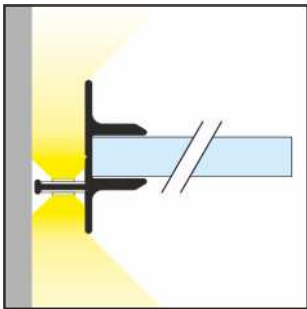
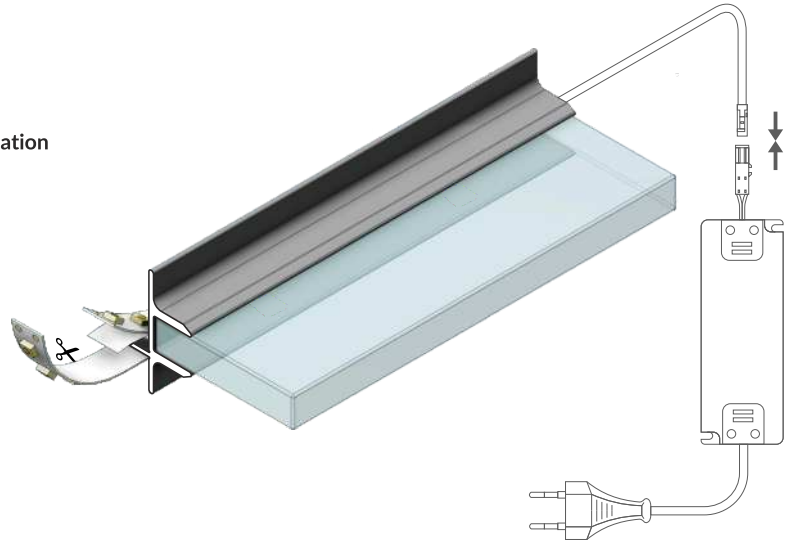

INDEX = 1 pc, length 2000 mm  
package = 10 pcs  
INDEKS = 1 szt., długość 2000 mm  
opakowanie = 10 szt.

**TWIN8**  
raw aluminium  
surowe aluminium  
82150000

**TWIN8 PLUS**  
raw aluminium  
surowe aluminium  
82160000

Available lengths / Dostępne długości  
1000 mm, 2000 mm, 3000 mm, 4000 mm

## THERMAL TAPE / TAŚMA TERMALNA

thermal tape 45 x 10 mm  
self adhesive, double-sided

taśma termalna 45 x 10 mm  
samoprzylepna, dwustronna

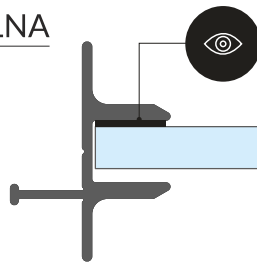

INDEX = 1 pc  
INDEKS = 1 szt.

53820000

LED profiles • glass application • TWIN8  
profile LED • do szyb • TWIN8



# MIKRO10

## A SMALL EDGE PROFILE FOR GLASS PANELS

### MAŁY PROFIL KRAWĘDZIOWY DO SZYB

- to illuminate the edge or engraving on the glass panel surface
  - to be used for furniture (display cases) or advertising
  - discreet form
  - fits the 6 mm thick glass panel
  - note: the profile is not a construction element
  - maximum LED strip width: 10 mm
- 
- do podświetlania krawędzi lub graweru na płaszczyźnie szyby
  - głównie do zastosowania meblowego (gabloty) lub reklamowego
  - dyskretna forma
  - do szyb o grubości 6 mm
  - uwaga: profil nie jest elementem konstrukcyjnym
  - maksymalna szerokość taśmy LED: 10 mm

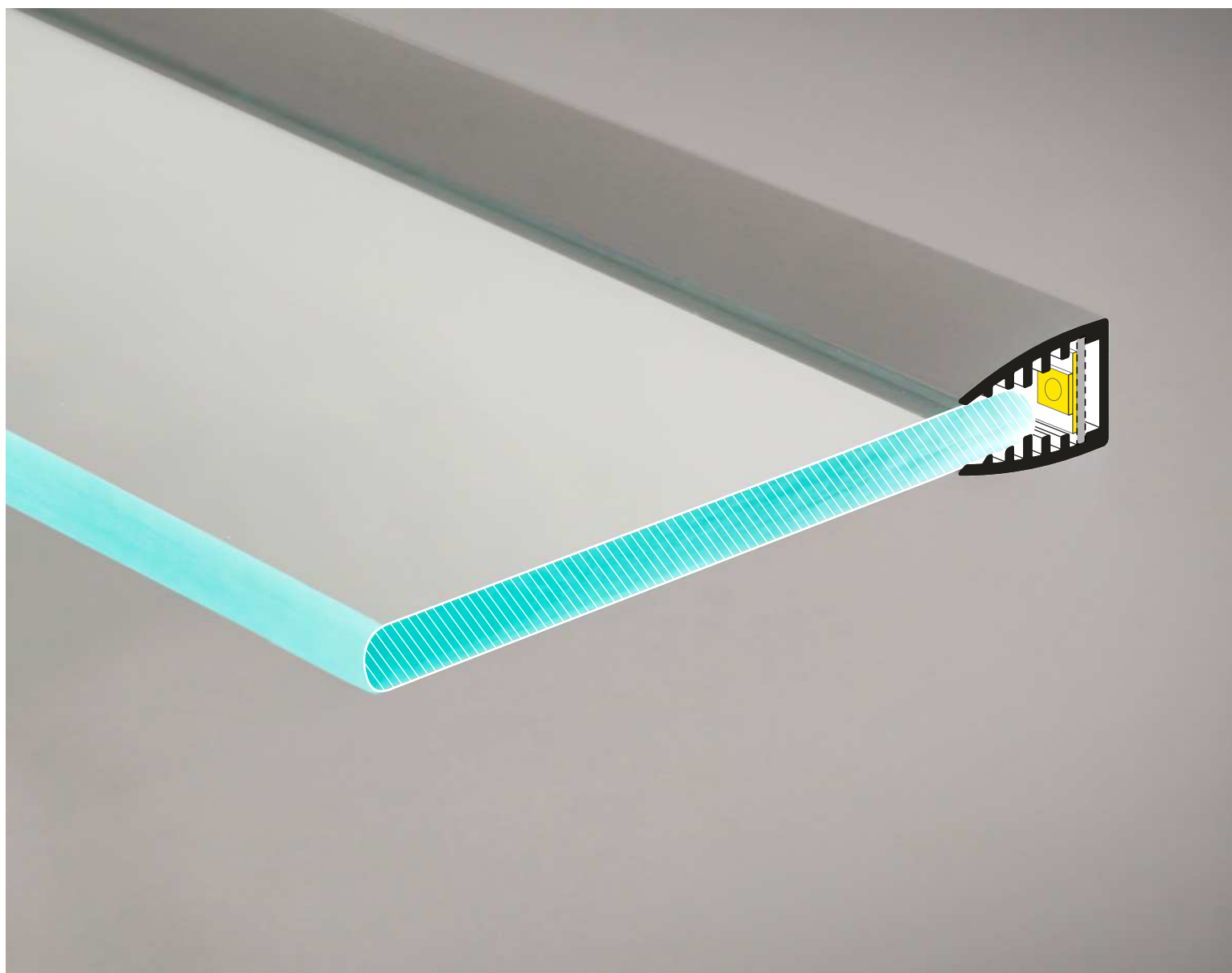

## SIMILAR IN THE OFFER / PODOBNE W OFERCIE



TWIN8



EDGE10  
BC



MIKRO-LINE12



CABI12  
E

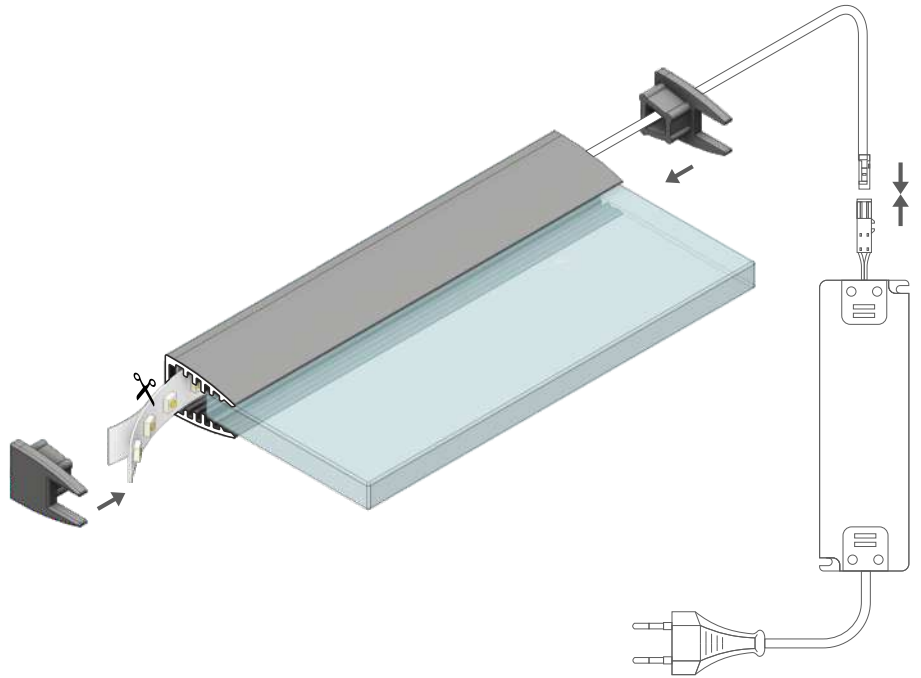
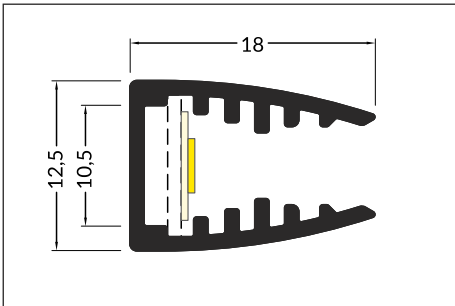
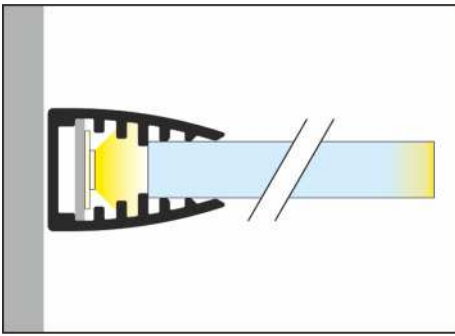

max 10 mm



glass application  
do szkła



INDEX = 1 pc, length 2000 mm  
package = 10 pcs  
INDEKS = 1 szt., długość 2000 mm  
opakowanie = 10 szt.

 anodized  
anodowany **68540020**

Available lengths / Dostępne długości  
1000 mm, 2000 mm, 3000 mm, 4000 mm

## ENDINGS / ZAŚLEPKI

**MIKRO10 ending**  
colours: silver, grey, transparent  
material: ABS, ABS, PC  
zaślepka MIKRO10  
kolory: srebrny, szary, transparentny  
materiał: ABS, ABS, PC

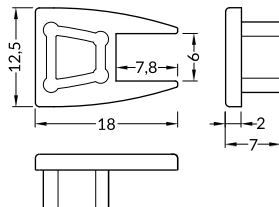

INDEX = 1 set  
package of 10 sets = 20 pcs  
INDEKS = 1 komplet, opakowanie  
zawiera 10 kompletów = 20 szt.

 silver  
srebrne **68550040**

 grey  
szare **68550022**

 transparent  
transparentne **68550000**

## LED MOUNTING / MOCOWANIE LED

**MIKRO10 LED mounting**  
material: HIPS  
mocowanie LED MIKRO10  
materiał: HIPS

INDEX = 1 pc, length 2000 mm  
package = 10 pcs  
INDEKS = 1 szt., długość 2000 mm  
opakowanie = 10 szt.

**68640000**

Available lengths / Dostępne długości  
1000 mm, 2000 mm



# EDGE10 BC

## FINISHING EDGES AND LIGHTING OF DISPLAY WINDOWS

### WYKOŃCZENIE KRAWĘDZI I OŚWIETLENIE EKSPOZYCJI

- the product for finishing and strengthening display window edges to a thickness up to 8 mm
- suitable for decorative 'framing' of the display window
- light is emitted at an angle - it does not cause glare
- top or bottom illumination
- easy installation - a double-sided tape not visible to customers
- when using on a thinner glass, consider additional wedging or adhesive tape
- maximum LED strip width: 10 mm
- wykańcza i wzmacnia krawędź szyby o grubości do 8 mm
- umożliwia budowanie ramki okalającej szybę
- światło skierowane pod kątem - nie powoduje ośnienia
- oświetlanie od góry lub od dołu
- łatwy montaż poprzez wklejenie - niewidoczne mocowanie taśmą dwustronną
- przy zastosowaniu do cieńszej szyby należy przewidzieć dodatkowe klinowanie lub klejenie taśmą
- maksymalna szerokość taśmy LED: 10 mm

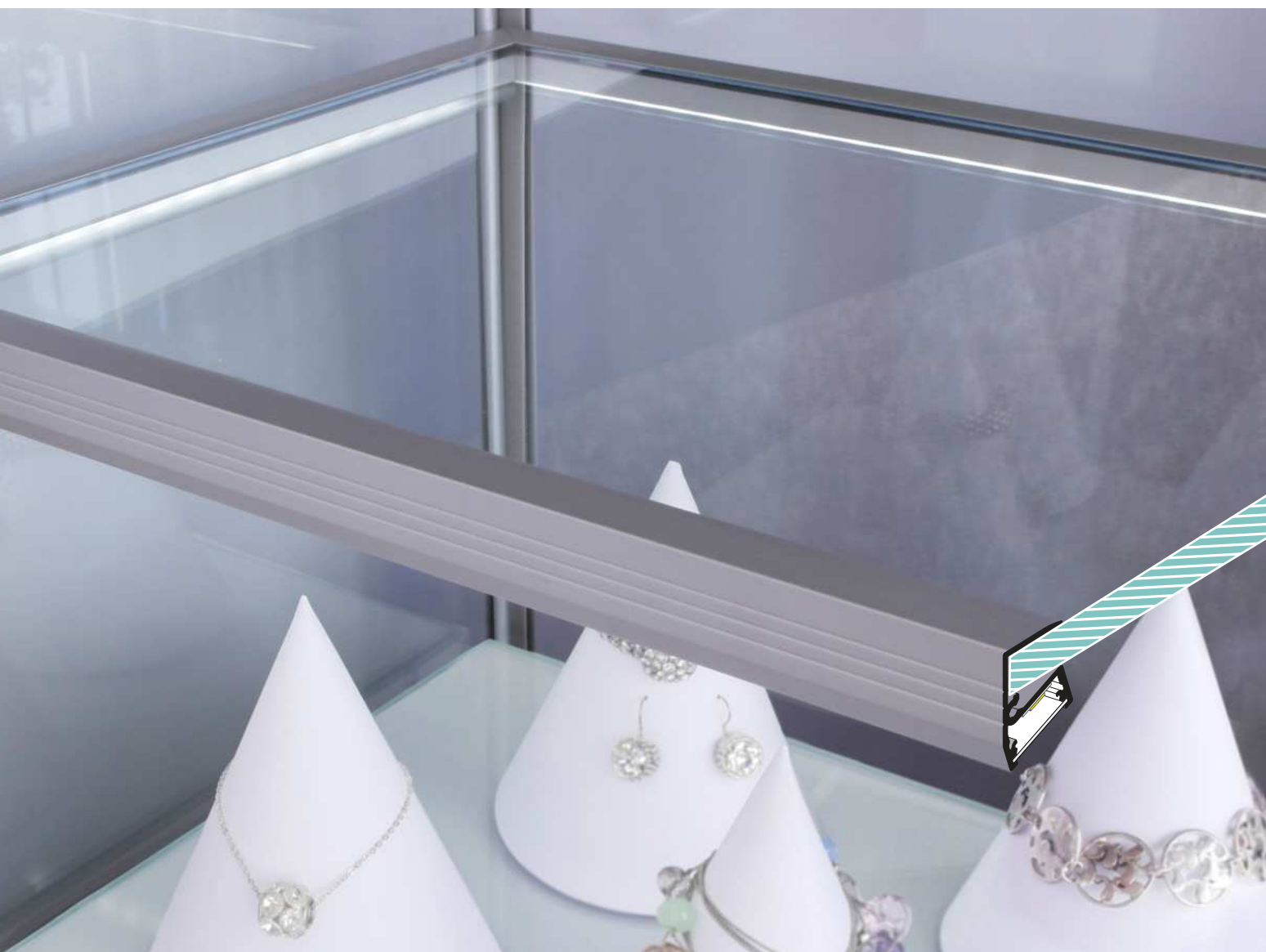

### SIMILAR IN THE OFFER / PODOBNE W OFERCIE



TWIN8



MIKRO10



MIKRO-LINE12



FRAME14  
BC/Q



CABI12  
E





**B** slide cover  
klosz B wsuwany

**C** click cover  
klosz C klik

**C** lens cover  
klosz C soczewka

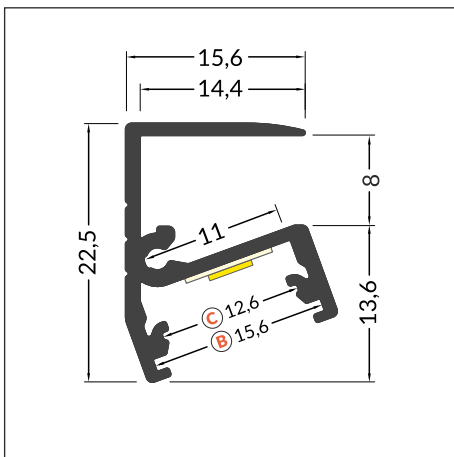
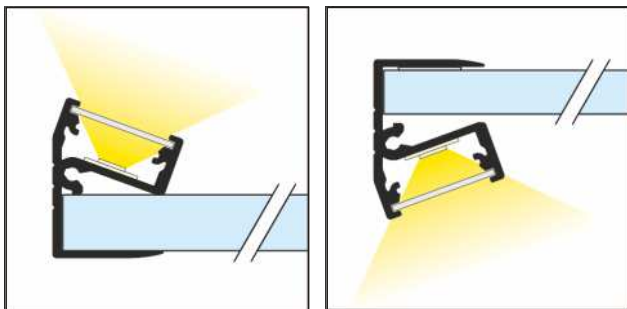
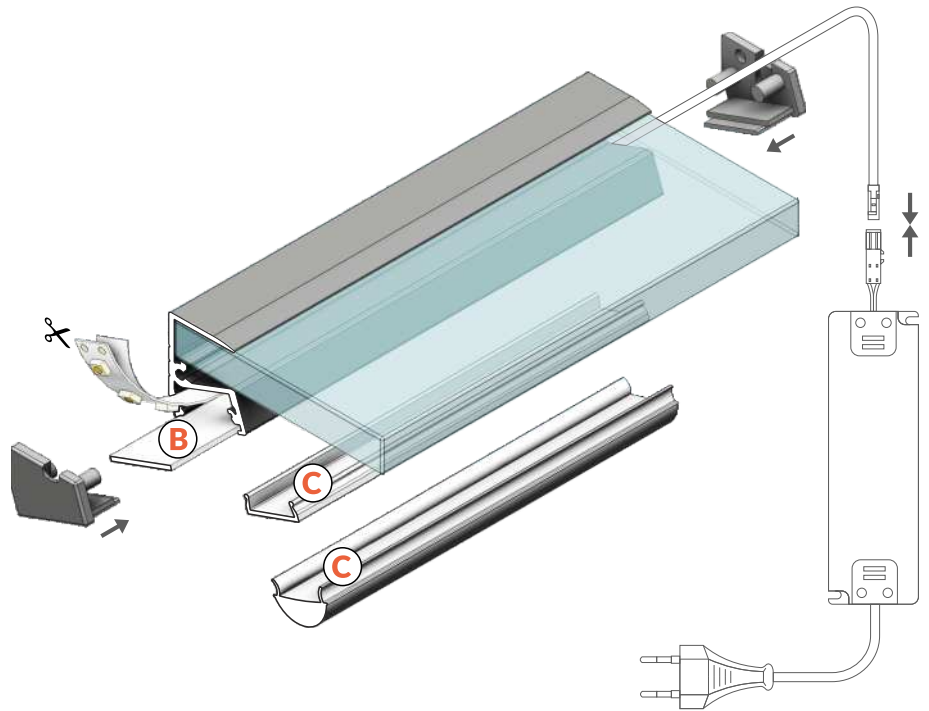

max 10 mm

glass application  
do szkła

INDEX = 1 pc, length 2000 mm  
package = 10 pcs  
INDEKS = 1 szt., długość 2000 mm  
opakowanie = 10 szt.

white painted  
biały malowany  
A9020001

anodized  
anodowany  
A9020020

black anodized  
czarny anodowany  
A9020021

raw aluminium  
surowe aluminium  
A9020000

Available lengths / Dostępne długości  
1000 mm, 2000 mm, 3000 mm, 4000 mm



## COVERS / KLOSZE

**B slide cover**  
colours: transparent, frosted, white  
material: PC, PP, PP

klosz B wsuwany  
kolory: transparentny, szron, mleczny  
materiał: PC, PP, PP

**Note!** Dimensions of the space to install LED source  
**Uwaga!** Wymiary przestrzeni do zamontowania źródła LED

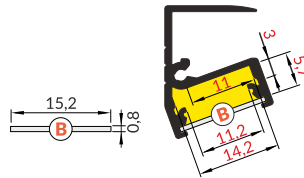

B transparent / B transparentny  
76250016

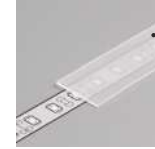

B frosted / B szron  
76250039



B white / B mleczny  
76250038

**C click cover**  
colours: transparent, white  
material: PMMA

klosz C klik  
kolory: transparentny, mleczny  
materiał: PMMA

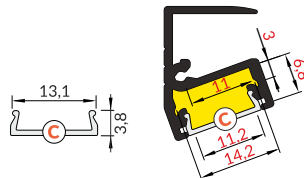

C transparent / C transparentny  
76330000



C white / C mleczny  
76330038

**C lens click cover**  
colour: transparent  
material: PC

klosz C klik soczewka  
kolor: transparentny  
materiał: PC

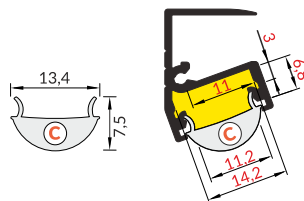

C lens / C soczewka  
76300000

## ENDINGS / ZAŚLEPKI

**EDGE10 ending with hole**  
colours: white, silver, black, grey  
material: ABS

zaślepka EDGE10 z otworem  
kolory: biały, srebrny, czarny, szary  
materiał: ABS

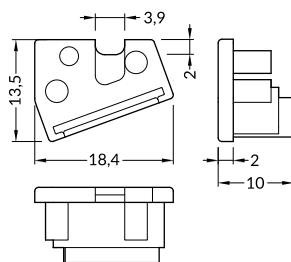

INDEX = 1 set,  
package of 10 sets = 20 pcs  
INDEKS = 1 komplet, opakowanie  
zawiera 10 kompletów = 20 szt.

	white białe	A9960001
	silver srebrne	A9960040
	black czarne	A9960002
	grey szare	A9960022

## THERMAL TAPE / TAŚMA TERMALNA

**thermal tape 45 x 10 mm**  
self adhesive, double-sided

taśma termalna 45 x 10 mm  
samoprzylepna, dwustronna

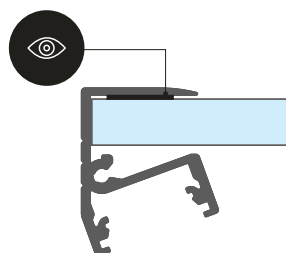

INDEX = 1 pc  
INDEKS = 1 szt.

53820000



Depending on the installation method, EDGE10 profile may illuminate the display area from the top or from below.

W zależności od sposobu montażu profil EDGE10 daje możliwość oświetlenia ekspozycji od góry lub od dołu.



# MIKRO-LINE12 J

## EDGE PROFILE FOR GLASS PANELS

### PROFIL KRAWĘDZIOWY DO SZYB

- decorative and lighting profile
- illuminates the edge or engraving on the glass panel surface
- for furniture and advertisement use mainly
- fits the 8 mm glass panels
- note: the profile is not a construction element
- maximum LED strip width: 12 mm
- profil dekoracyjno-oświetleniowy
- oświetla krawędź lub grawer na płaszczyźnie szyby
- głównie do użytku meblowego i reklamowego
- pasuje do szyb 8 mm
- uwaga: profil nie jest elementem konstrukcyjnym
- maksymalna szerokość taśmy LED: 12 mm

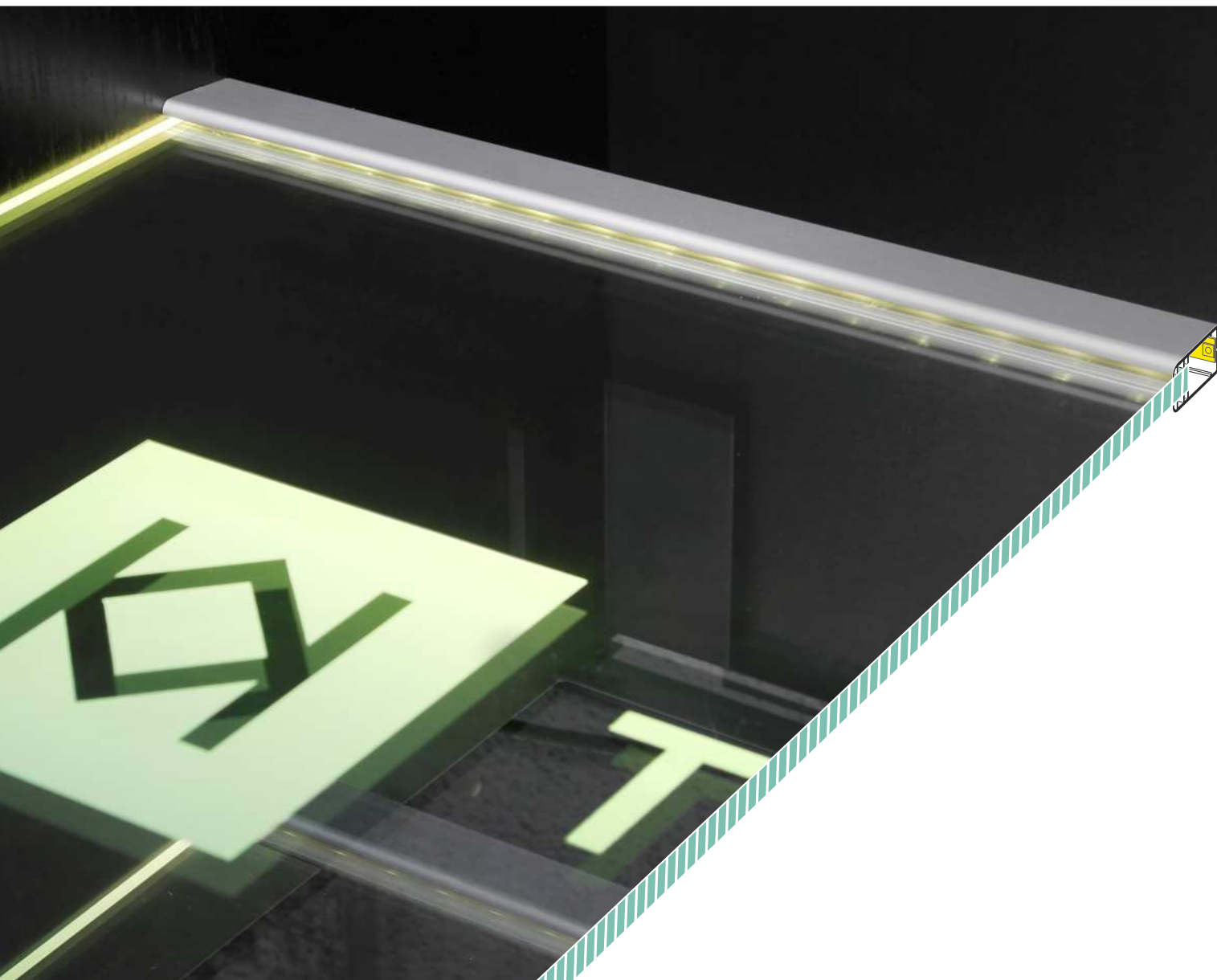

## SIMILAR IN THE OFFER / PODOBNE W OFERCIE



TWIN8



EDGE10  
BC



MIKRO10



CABI12  
E

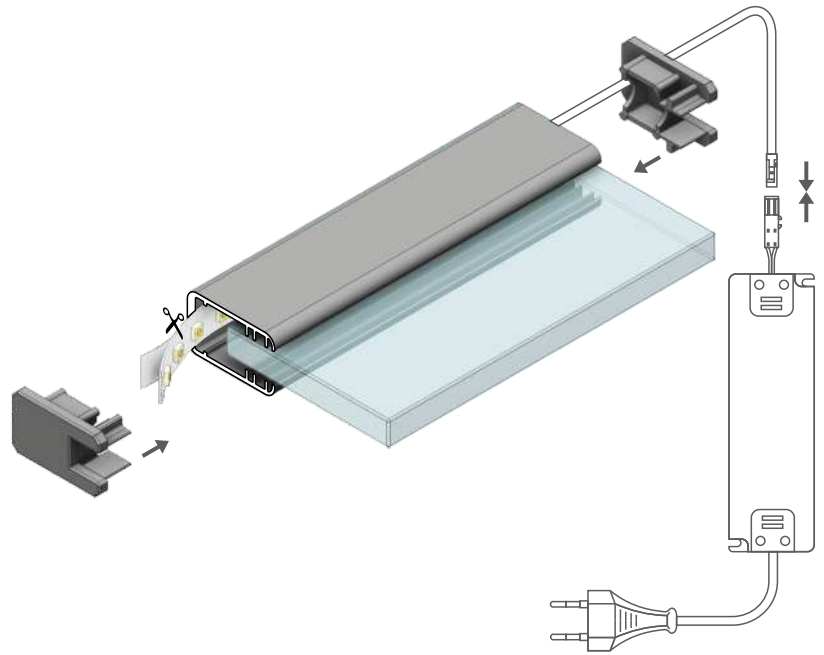
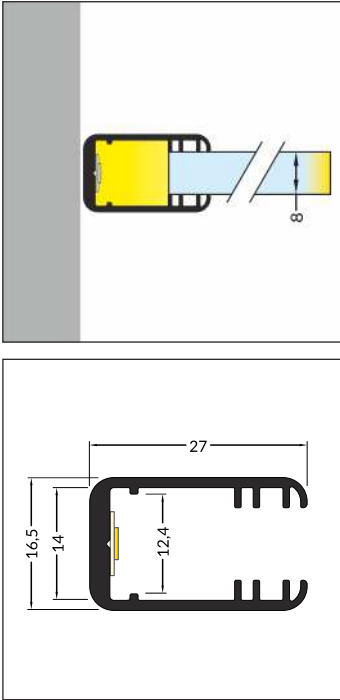

max 12 mm



glass application  
do szkła



available in stock  
dostępny na magazynie



INDEX = 1 pc, length 2000 mm  
package = 10 pcs  
INDEKS = 1 szt., długość 2000 mm  
opakowanie = 10 szt.

anodized  
anodowany  
70280020

raw aluminium  
surowe aluminium  
70280000

Available lengths / Dostępne długości  
1000 mm, 2000 mm, 3000 mm, 4000 mm

## ENDINGS / ZAŚLEPKI

**MIKRO-LINE12 ending**  
colours: silver, grey, transparent  
material: ABS, ABS, PC  
zaślepka MIKRO-LINE12  
kolory: srebrny, szary, transparentny  
materiał: ABS, ABS, PC

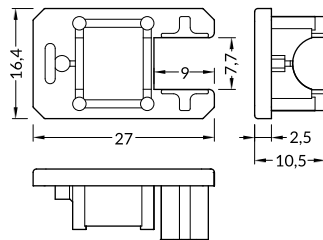

INDEX = 1 set  
package of 10 sets = 20 pcs  
INDEKS = 1 komplet, opakowanie  
zawiera 10 kompletów = 20 szt.

silver  
srebrne 70290040

grey  
szare 70290022

transparent  
transparentne 70290000



**Note!** Dimensions of the space to install LED source  
**Uwaga!** Wymiary przestrzeni do zamontowania źródła LED

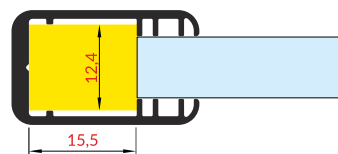

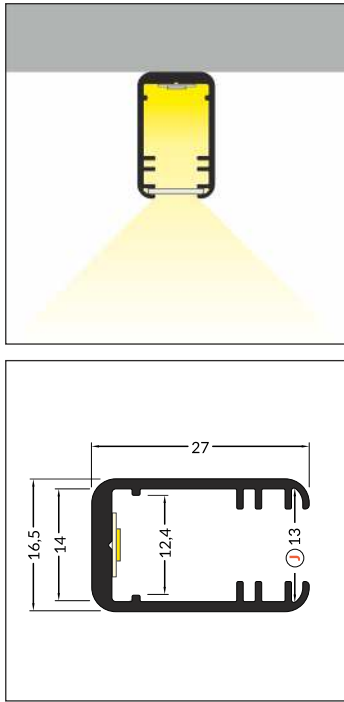

**J** slide cover  
klosz **J** wsuwany

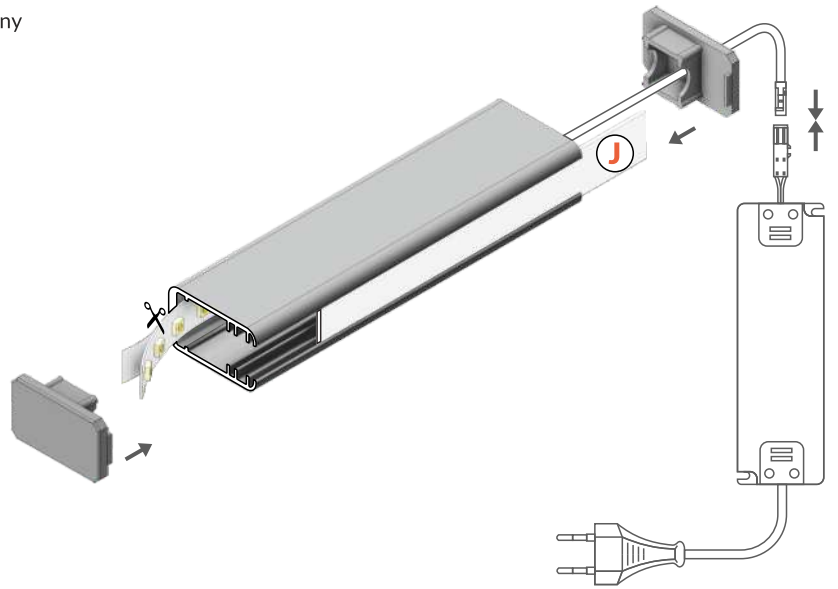

max 12 mm

special application  
specjalny

available in stock  
dostępny na magazynie



INDEX = 1 pc, length 2000 mm  
package = 10 pcs  
INDEKS = 1 szt., długość 2000 mm  
opakowanie = 10 szt.

anodized  
anodowany  
**70280020**

raw aluminium  
surowe aluminium  
**70280000**

Available lengths / Dostępne długości  
1000 mm, 2000 mm, 3000 mm, 4000 mm

## ENDINGS / ZAŚLEPKI

**MIKRO-LINE12 LINIA ending**  
colours: silver, grey, transparent  
material: ABS, ABS, PC  
zaślepka MIKRO-LINE12 LINIA  
kolory: srebrny, szary, transparentny  
material: ABS, ABS, PC

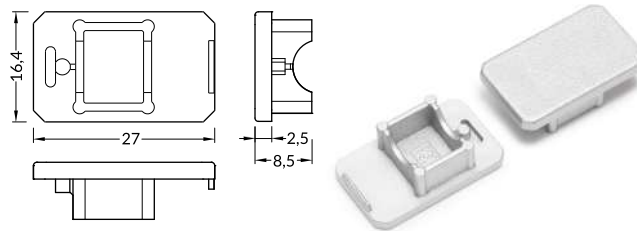

INDEX = 1 set  
package of 10 sets = 20 pcs  
INDEKS = 1 komplet, opakowanie  
zawiera 10 kompletów = 20 szt.

silver  
srebrne **70300040**

grey  
szare **70300022**

transparent  
transparentne **70300000**

## COVERS / KLOSZE

**J slide cover**  
colours: transparent, frosted, white  
material: PC, PP, PP

klosz **J** wsuwany  
kolory: transparentny, szron, mleczny  
materiał: PC, PP, PP

**Note!** Dimensions of the space  
to install LED source  
**Uwaga!** Wymiary przestrzeni  
do zamontowania źródła LED

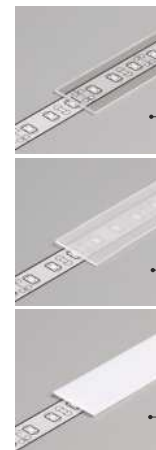
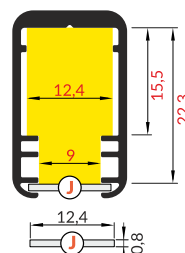

INDEX = 1 pc, length 2000 mm  
package = 10 pcs  
INDEKS = 1 szt., długość 2000 mm  
opakowanie = 10 szt.

transparent / transparentny  
**70330016**

frosted / szron  
**70330039**

white / mleczny  
**70330038**

**PROFILE APPLICATION:  
ZASTOSOWANIE PROFILU:**



With white cover - continuous light line.  
Z kloszem mlecznym - ciągła linia światła.



With glass panel - illumination of sandblasted edge.  
Z szybą - podświetlenie piaskowanej krawędzi.





53

**BIG PROFILES**  
**DUŽE PROFILE**

**2017**

**LED profiles**  
**profile LED**

# BIG PROFILES

## DUŻE PROFILE





## PHIL53 profile / profil PHIL53

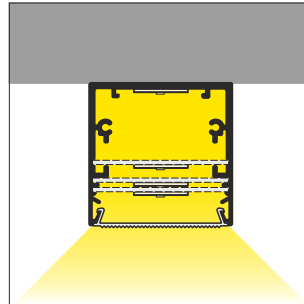
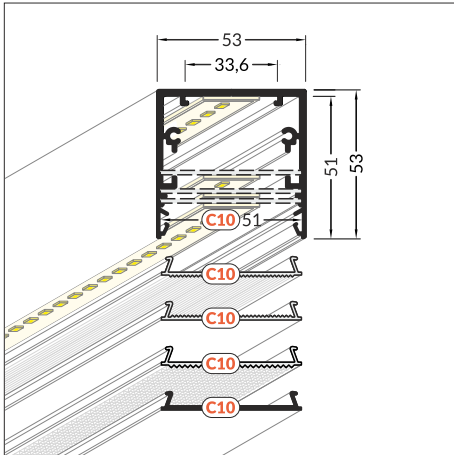

INDEX = 1 pc, length 2000 mm  
INDEX = 1 szt., długość 2000 mm

-  white painted  
biały malowany  
**63530001**
-  anodized  
anodowany  
**63530020**
-  black painted  
czarny malowany  
**63530002**
-  raw aluminium  
surowe aluminium  
**63530000**

Available lengths / Dostępne długości  
1000 mm, 2000 mm, 3000 mm, 4000 mm

## ENDINGS / ZAŚLEPKI

**PHIL53 ending**  
colours: white, silver, black, grey  
material: ABS

zaślepka PHIL53  
kolory: biały, srebrny, czarny, szary  
materiał: ABS

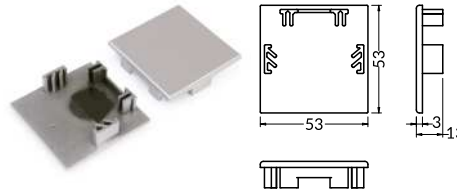

INDEX = 1 set = 2 pcs  
INDEKS = 1 komplet = 2 szt.

-  white  
biały **63640001**
-  silver  
srebrny **63640040**
-  black  
czarny **63640002**
-  grey  
szary **63640022**

## PHIL recessed profile / profil PHIL wpust

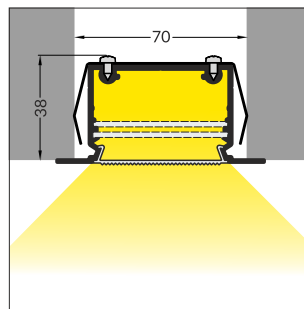
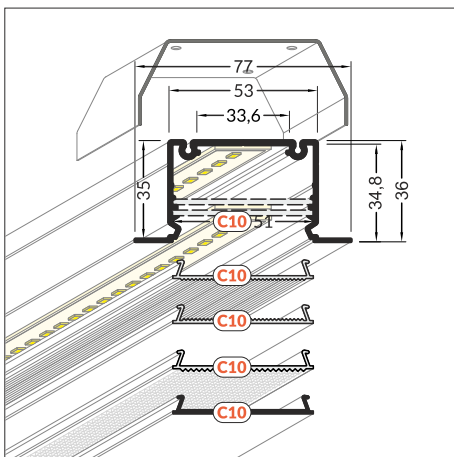

INDEX = 1 pc, length 2000 mm  
INDEX = 1 szt., długość 2000 mm

-  white painted  
biały malowany  
**97100001**
-  anodized  
anodowany  
**97100020**
-  black painted  
czarny malowany  
**97100002**
-  raw aluminium  
surowe aluminium  
**97100000**

Available lengths / Dostępne długości  
1000 mm, 2000 mm, 3000 mm, 4000 mm

## MOUNTING / MOCOWANIE

**PHIL recessed holder**  
colour: inox  
material: stainless steel

uchwyt PHIL wpust  
kolor: inox  
materiał: stal nierdzewna

INDEX = 1 set = 2 pcs  
INDEKS = 1 komplet = 2 szt.

 inox  
inox **97510019**

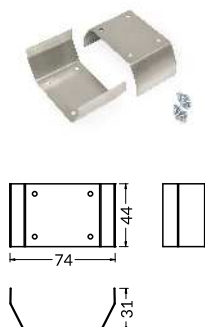

## ENDINGS / ZAŚLEPKI

**PHIL recessed ending**  
colours: white, silver, black  
material: steel

zaślepka PHIL wpust  
kolory: biały, srebrny, czarny  
materiał: stal

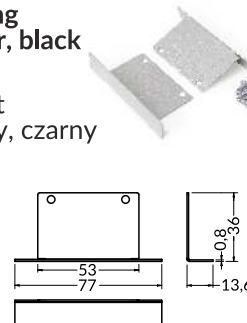

INDEX = 1 set = 2 pcs  
INDEKS = 1 komplet = 2 szt.

-  white  
biały **97120001**
-  silver  
srebrny **97120022**
-  black  
czarny **97120002**



## LOWI profile / profil LOWI

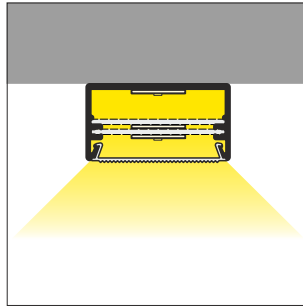
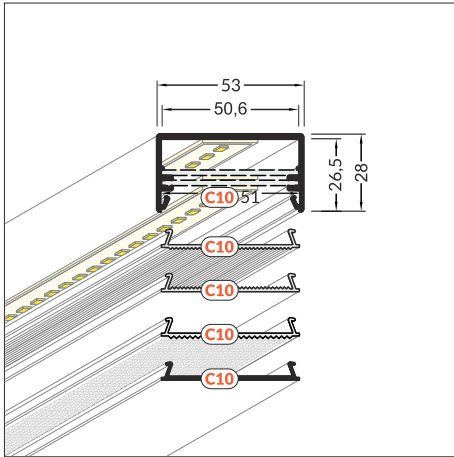

INDEX = 1 pc, length 2000 mm  
INDEKS = 1 szt., długość 2000 mm

-  white painted  
biały malowany  
**93030001**
-  anodized  
anodowany  
**93030020**
-  black painted  
czarny malowany  
**93030002**
-  raw aluminium  
surowe aluminium  
**93030000**

Available lengths / Dostępne długości  
1000 mm, 2000 mm, 3000 mm, 4000 mm

## ENDINGS / ZAŚLEPKI

LOWI ending  
colours: white, silver, black, grey  
material: ABS

zaślepka LOWI  
kolory: biały, srebrny, czarny, szary  
materiał: ABS

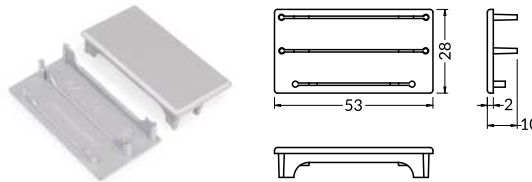

INDEX = 1 set = 2 pcs  
INDEKS = 1 komplet = 2 szt.

-  white  
biały **93040001**
-  silver  
srebrny **93040040**
-  black  
czarny **93040002**
-  grey  
szary **93040022**

## COVERS / KLOSZE

**C10 NARROW cover**  
material: polycarbonate  
klosz C10 NARROW  
materiał: poliwęglan

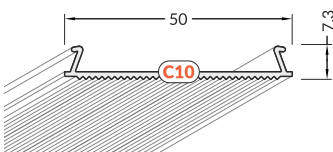

INDEX = 1 pc, length 2000 mm  
INDEKS = 1 szt., długość 2000 mm

**63620000**

**C10 WIDE cover**  
material: polycarbonate  
klosz C10 WIDE  
materiał: poliwęglan

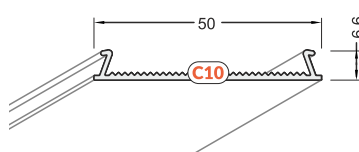

INDEX = 1 pc, length 2000 mm  
INDEKS = 1 szt., długość 2000 mm

**63590000**

**C10 OPAL cover**  
material: PMMA  
klosz C10 OPAL  
materiał: PMMA

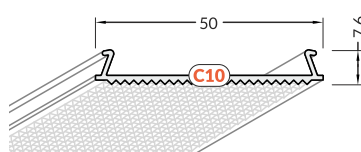

INDEX = 1 pc, length 2000 mm  
INDEKS = 1 szt., długość 2000 mm

**63690038**

## COVER / OSŁONA

**C10 aluminium cover**  
material: aluminium  
osłona aluminiowa C10  
materiał: aluminium

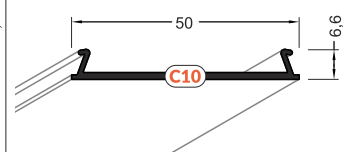

INDEX = 1 pc, length 2000 mm  
INDEKS = 1 szt., długość 2000 mm

-  white painted  
biały malowany  
**63560001**
-  anodized  
anodowany  
**63560020**
-  black painted  
czarny malowany  
**63560002**
-  raw aluminium  
surowe aluminium  
**63560000**

Available lengths / Dostępne długości  
1000 mm, 2000 mm, 3000 mm, 4000 mm

Comparison of variations in the light curves measured on different C10 covers  
Porównanie krzywych światłości przy zastosowaniu różnych kloszy C10

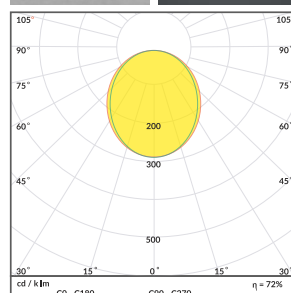
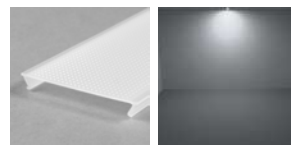
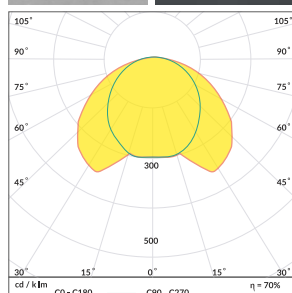
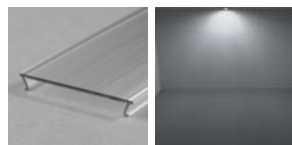
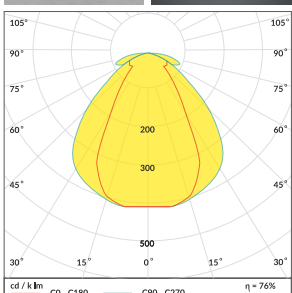
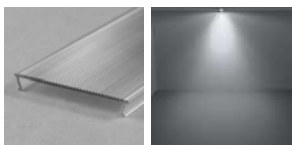



LED mounting 50  
material: aluminium  
mocowanie LED 50  
material: aluminium

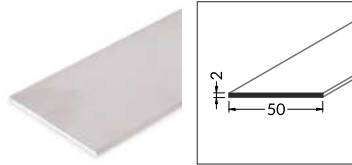

INDEX = 1 pc, length 2000 mm  
INDEX = 1 szt., długość 2000 mm



raw aluminium  
surowe aluminium

25090000

Available lengths / Dostępne długości  
1000 mm, 2000 mm, 3000 mm, 4000 mm

## DIMENSIONS TO INSTALL LIGHT SOURCE WYMIARY PRZESTRZENI DO ZAMONTOWANIA ŹRÓDŁA ŚWIATŁA

### PHIL53 profile profil PHIL53

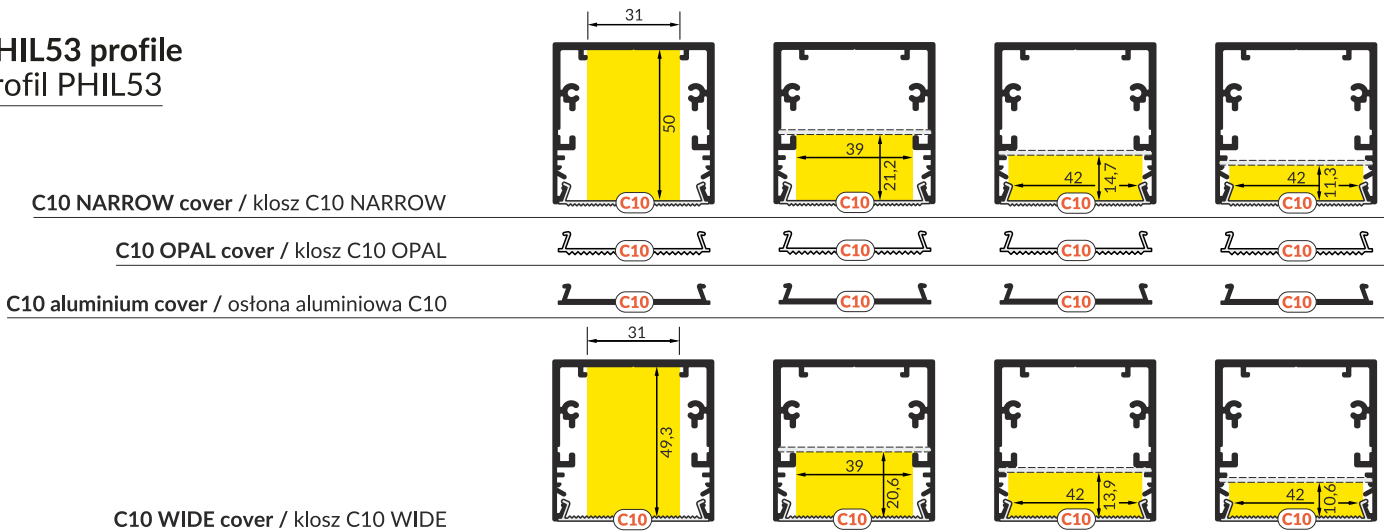

### PHIL recessed profile profil PHIL wpust

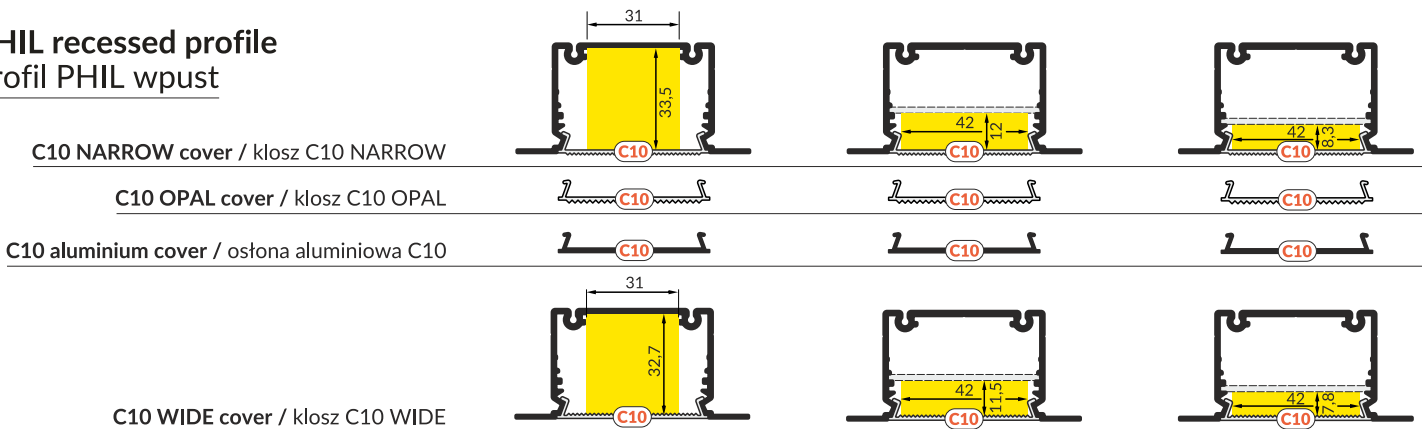

### LOWI profile profil LOWI

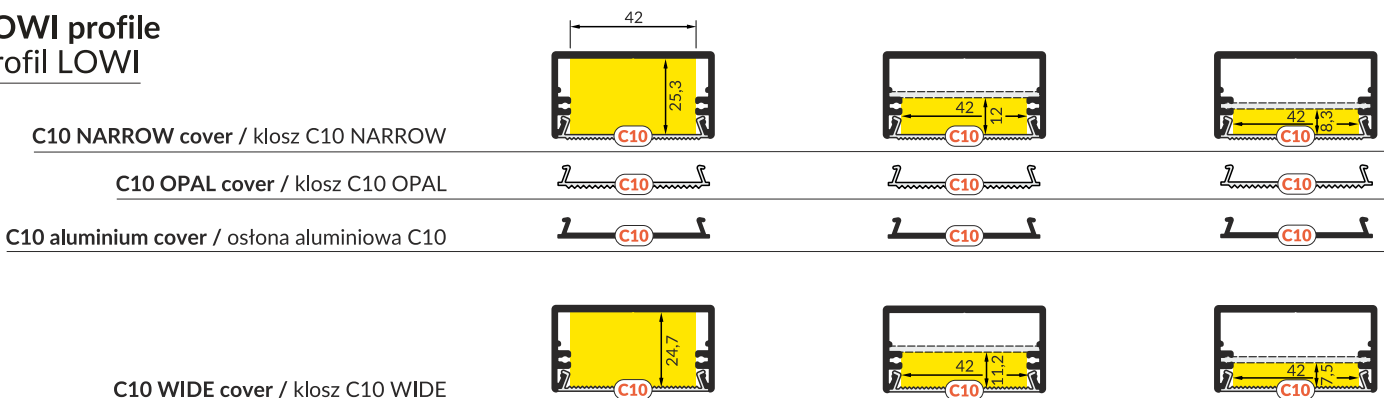





**LED ACCESSORIES**  
**AKCESORIA LED**

**2017**

**LED profiles**  
**profile LED**





## PREMIUM LED strips (P)

taśmy LED z serii PREMIUM (P)



### OSRAM LINEARlight VALUE Flex ECO VFEG1-FLX-300 (P) 24V; 4,2W/m

B4070000 - 827; 300 lm/m  
B4080000 - 830; 330 lm/m  
B4090000 - 865; 340 lm/m

MOQ = 1 reel = 9939 mm  
minimalna ilość zamówienia = 1 rolka = 9939 mm

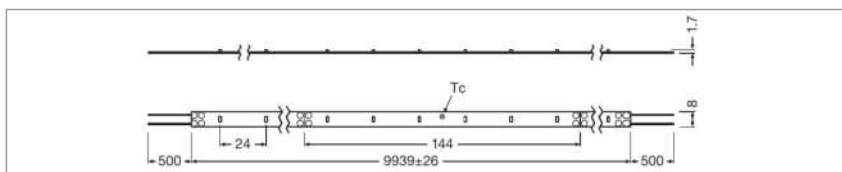

### OSRAM LINEARlight VALUE Flex VF600-G2 (P) 24V; 7,7W/m

B4100000 - 827; 600 lm/m  
B4110000 - 830; 600 lm/m  
B4120000 - 840; 700 lm/m  
B4130000 - 865; 700 lm/m

MOQ = 1 reel = 5998 mm  
minimalna ilość zamówienia = 1 rolka = 5998 mm

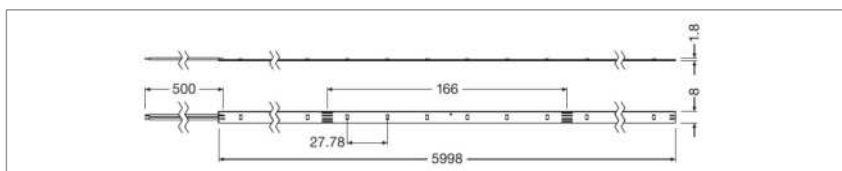
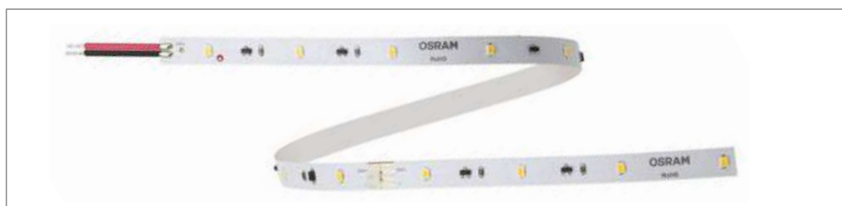

### OSRAM LINEARlight VALUE Flex IP ECO VFEPG1-FLX-300 (P) 24V; 4,2W/m IP66 (water resistant • na zewnątrz)

B4140000 - 830; 250 lm/m  
B4150000 - 860; 280 lm/m

MOQ = 1 reel = 6091 mm  
minimalna ilość zamówienia = 1 rolka = 6091 mm

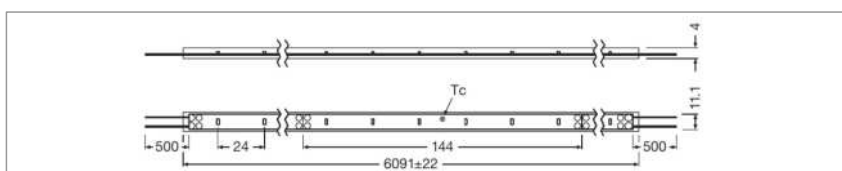

### OSRAM LINEARlight VALUE Flex IP PROTECT VFP600-G2 (P) 24V; 7,7W/m IP66 (water resistant • na zewnątrz)

B4160000 - 830; 575 lm/m  
B4170000 - 865; 600 lm/m

MOQ = 1 reel = 6018 mm  
minimalna ilość zamówienia = 1 rolka = 6018 mm

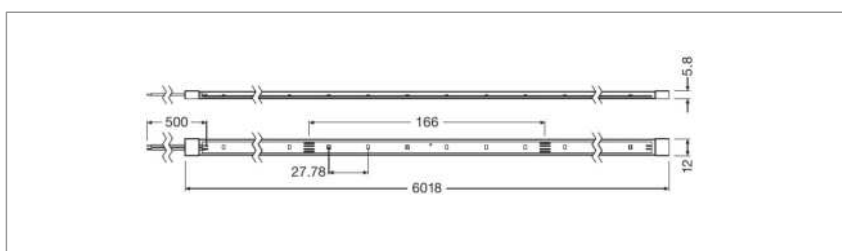
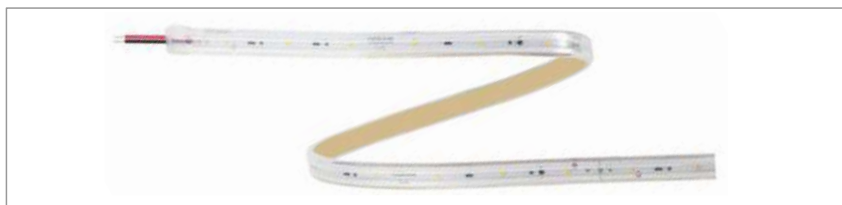

3 years warranty on LED strips when using OSRAM 24V power supplies  
3 Lata gwarancji na taśmy wyłącznie z zasilaczami OSRAM 24V

see page 9.6 for OSRAM 24V power supplies • zasilacze do taśm OSRAM 24V patrz str. 9.6

## STANDARD LED strips (S)

taśmy LED z serii STANDARD (S)

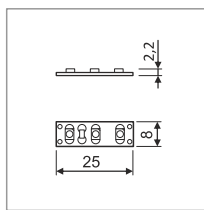
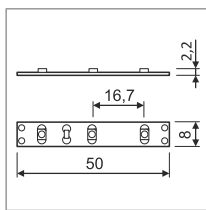

**LED strip 3528 (S)**  
taśma LED 3528 (S)  
12V; 4,8W/m; 60P/m

**B4200000**  
2800-3200 K  
360 lm/m ± 10%  
Ra>80

**B4210000**  
4000-4500 K  
360 lm/m ± 10%  
Ra>80

**LED strip 3528 (S)**  
taśma LED 3528 (S)  
12V; 9,6W/m; 120P/m

**B4240000**  
2800-3200 K  
720 lm/m ± 10%  
Ra>80

**B4250000**  
4000-4500 K  
720 lm/m ± 10%  
Ra>80

MOQ = 1 reel = 5 m

minimalna ilość zamówienia = 1 rolka = 5 m

## BUDGET LED strips (B)

taśmy LED z serii BUDGET (B)

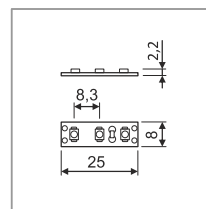
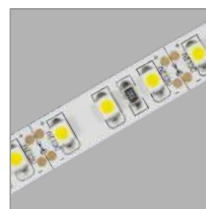
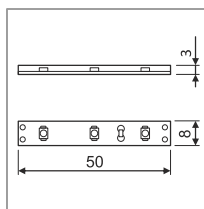
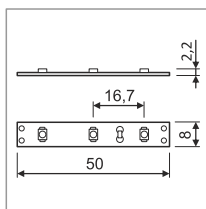
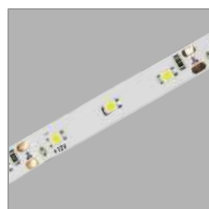

**LED strip 3528 (B)**  
taśma LED 3528 (B)  
12V; 4,8W/m; 60P/m

**85414010**  
cool white  
biały zimny

**85414016**  
yellow  
żółty

**85414011**  
warm white  
biały ciepły

**85414017**  
red  
czerwony

**85414012**  
blue  
niebieski

**85414018**  
green  
zielony

**LED strip 3528 (B)**  
taśma LED 3528 (B)  
12V; 4,8W/m; 60P/m; IP65

**85414031**  
cool white  
biały zimny

**85414032**  
warm white  
biały ciepły

**LED strip 3528 (B)**  
taśma LED 3528 (B)  
12V; 9,6W/m; 120P/m

**85414055**  
cool white  
biały zimny

**85414056**  
warm white  
biały ciepły

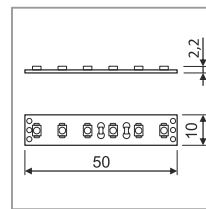
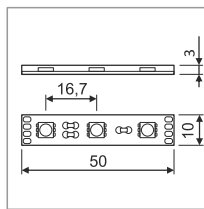
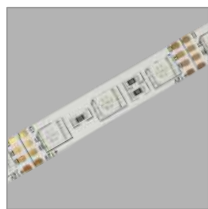
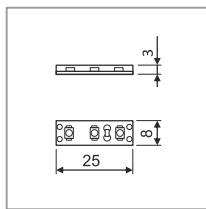
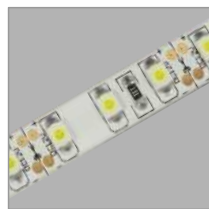

**LED strip 3528 (B)**  
taśma LED 3528 (B)  
12V; 9,6W/m; 120P/m; IP65

**85414029**  
cool white  
biały zimny

**85414028**  
warm white  
biały ciepły

**LED strip 5050 RGB (B)**  
taśma LED 5050 RGB (B)  
12V; 14,4W/m; 60P/m; IP65

**85414077**

**LED strip 3528 warm-cool white (B)**  
taśma LED 3528 biały ciepły-zimny (B)  
12V; 9,6W/m; 120P/m

**84509900**

MOQ = 1 reel = 5 m

minimalna ilość zamówienia 1 rolka = 5 m

see page 9.5 for power supplies  
zasilacze do taśm patrz str. 9.5

## TOPMET Light PREMIUM LED modules

### moduły LED PREMIUM TOPMET Light

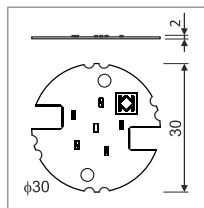
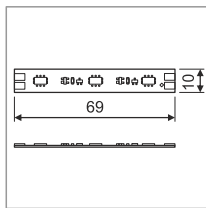

#### LED module

moduł LED

12V; 1,5W; 3led

85600300 - 2700 K 146 lm

85610300 - 3000 K 148 lm

85620300 - 4000 K 155 lm

Ra>80

#### LED module

moduł LED

12V; 1,5W; 6led

85414072 - 2700 K 106 lm

85414074 - 3000 K 110 lm

85414073 - 4000 K 115 lm

Ra>80

### 50 000 h durability of TOPMET Light PREMIUM LED modules

50 000 h trwałości modułów LED PREMIUM TOPMET Light

see page 9.5 for power supplies

zasilacze do modułów LED patrz str. 9.5

## LED power supplies

### zasilacze LED

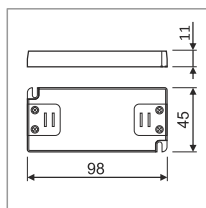

**LED power supply**  
zasilacz LED  
12V/6W; 200-240V

15700000

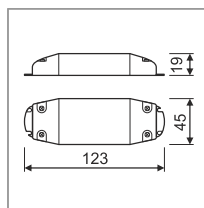

**LED power supply**  
zasilacz LED  
12V/15W; 200-240V

15850000

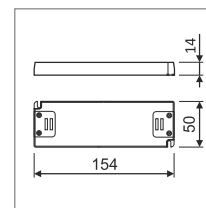
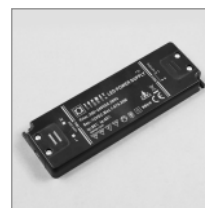

**LED power supply**  
zasilacz LED  
12V/20W; 200-240V

15640000

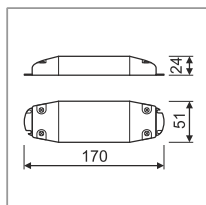

**LED power supply**  
zasilacz LED  
12V/30W; 200-240V

15810000

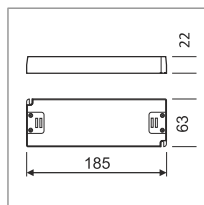

**LED power supply**  
zasilacz LED  
12V/50W; 200-240V

15650000

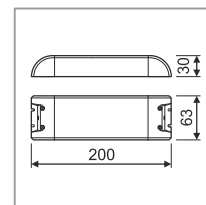

**LED power supply**  
zasilacz LED  
12V/75W; 200-240V

15800000

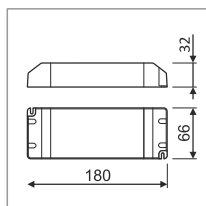

**LED power supply**  
zasilacz LED  
12V/100W; 100-240V

15760000

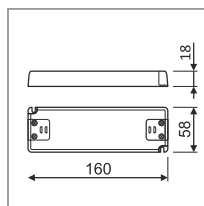

**LED power supply**  
zasilacz LED  
24V/30W; 200-240V

15770000

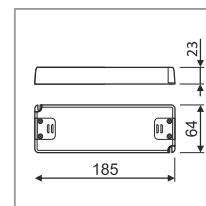

**LED power supply**  
zasilacz LED  
24V/60W; 200-240V

15780000

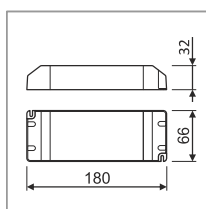

**LED power supply**  
zasilacz LED  
24V/100W; 100-240V

15790000

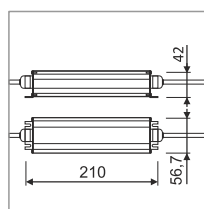

**LED power supply**  
zasilacz LED  
12V/100W; 200-240V; IP68

15710000

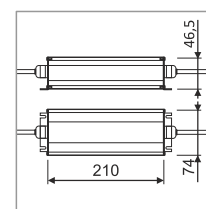

**LED power supply**  
zasilacz LED  
12V/150W; 200-240V; IP68

15720000

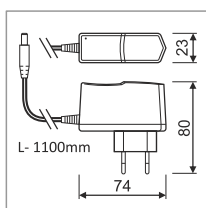

**LED power supply AC adapter**  
zasilacz LED wtyczkowy  
12V/12W; 100-240V

15480002

see pages 9.2-9.4 for LED modules and strips • moduły i taśmy LED patrz str. 9.2-9.4

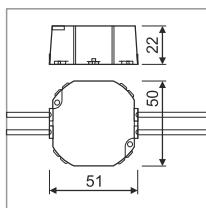

**LED OSRAM OT power supply**  
zasilacz LED OSRAM OT  
6W/200-240/24V CE

53430000

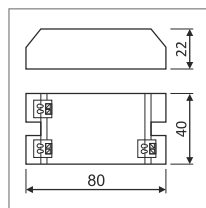

**LED OSRAM OT power supply**  
zasilacz LED OSRAM OT  
8W/200-240/24V

53440000

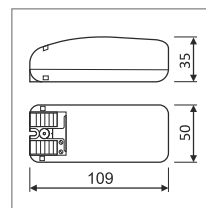

**LED OSRAM OT power supply**  
zasilacz LED OSRAM OT  
20W/220-240/24V

53450000

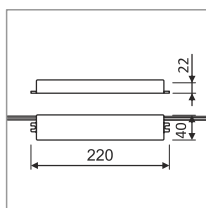

**LED OSRAM OT power supply**  
zasilacz LED OSRAM OT  
30W/220-240/24V P

53500000

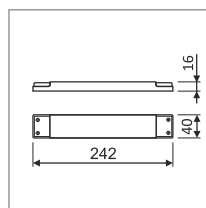

**LED OSRAM OT power supply**  
zasilacz LED OSRAM OT  
50W/220-240/24V

53470000

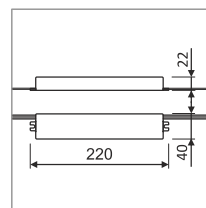

**LED OSRAM OT power supply**  
zasilacz LED OSRAM OT  
50W/220-240/24V P

53510000

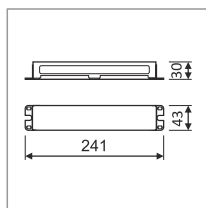

**LED OSRAM OT power supply**  
zasilacz LED OSRAM OT  
75W/220-240/24V E

53490000

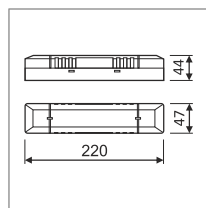

**LED OSRAM OT power supply**  
zasilacz LED OSRAM OT  
75W/220-240/24V

53480000

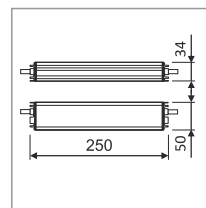

**LED OSRAM OT power supply**  
zasilacz LED OSRAM OT  
80W/220-240/24V P

53520000

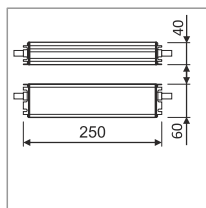

**LED OSRAM OT power supply**  
zasilacz LED OSRAM OT  
120W/220-240/24V P

53530000

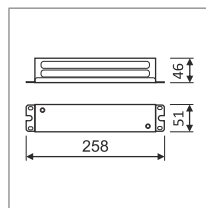

**LED OSRAM OT power supply**  
zasilacz LED OSRAM OT  
120W/220-240/24V E

53540000

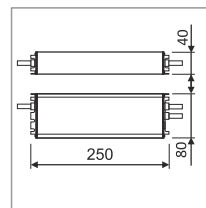

**LED OSRAM OT power supply**  
zasilacz LED OSRAM OT  
240W/220-240/24V P

53550000

see page 9.2 for OSRAM LED strips • taśmy LED OSRAM patrz str. 9.2

## power supply cases

### obudowy do zasilaczy

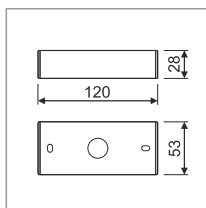

**power supply case**  
obudowa do zasilacza  
48 x 12 x 100

67160001	white • biały
67160002	black • czarny
67160020	anod.

**LED power supplies**  
**maximum dimensions**  
maksymalne rozmiary  
zasilaczy LED

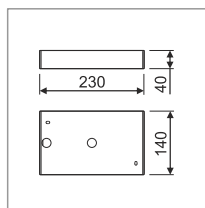
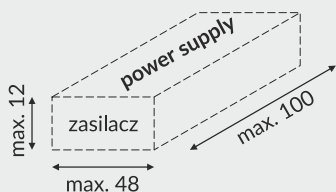

**power supply case**  
obudowa do zasilacza  
120 x 27 x 216

67170001	white • biały
67170002	black • czarny
67170020	anod.

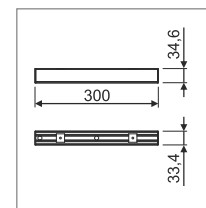
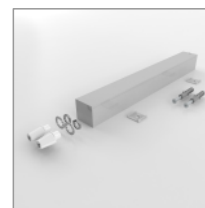

**power supply case**  
obudowa do zasilacza  
31 x 23 x 286

67180001	white • biały
67180002	black • czarny
67180020	anod.

**LED power supplies**  
**maximum dimensions**  
maksymalne rozmiary  
zasilaczy LED

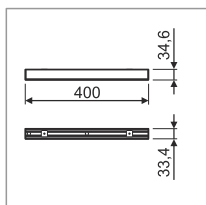
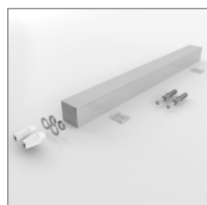
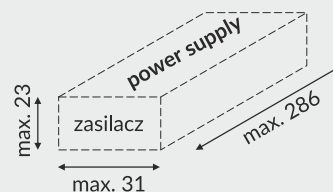

**power supply case**  
obudowa do zasilacza  
31 x 23 x 386

67190001	white • biały
67190002	black • czarny
67190020	anod.

**LED power supplies**  
**maximum dimensions**  
maksymalne rozmiary  
zasilaczy LED

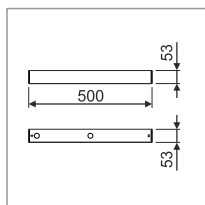
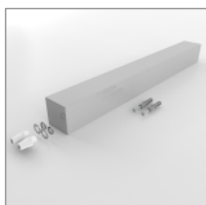
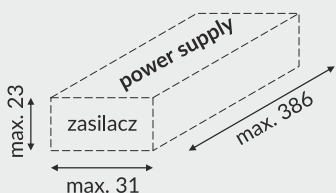

**power supply case**  
obudowa do zasilacza  
36 x 46 x 474

67200001	white • biały
67200002	black • czarny
67200020	anod.

**LED power supplies**  
**maximum dimensions**  
maksymalne rozmiary  
zasilaczy LED

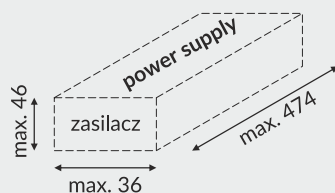

see pages 9.5-9.6 for power supplies  
zasilacze do modułów LED patrz str. 9.5-9.6

## lighting controllers and switches

### czujniki sterujące i włączniki

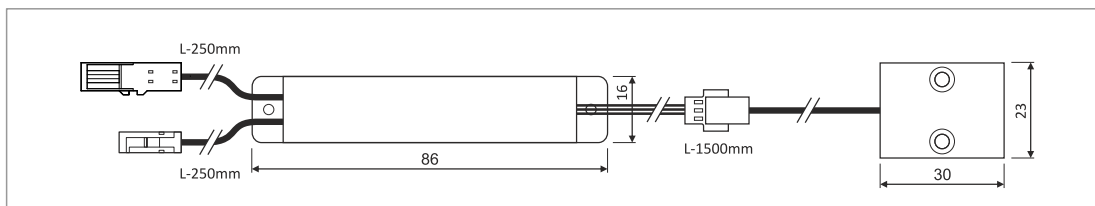

**door operated sensor switch**  
włącznik bezdotykowy drzwiowy  
12-24V/30W

15530000

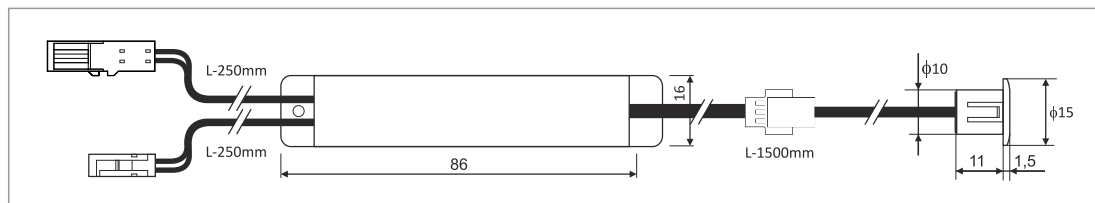

**hand operated sensor switch**  
włącznik bezdotykowy ręczny  
12-24V/30W

15540000

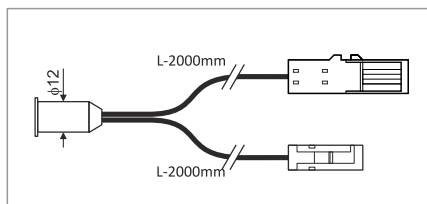

**touch sensor ON/OFF switch**  
włącznik dotykowy ON/OFF  
12V/30W

15630000

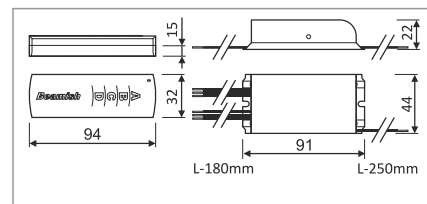

**3 channel remote controller ON/OFF**  
pilot z włącznikiem radiowym 3-kanalowy ON/OFF  
230V/1000W

78530000

## lighting controllers and switches

### czujniki sterujące i włączniki

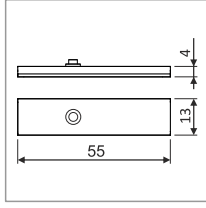

**LED SU/GR/CO dimmable switch**  
włącznik LED SU/GR/CO ściemniany  
12-24V/35W

53850000

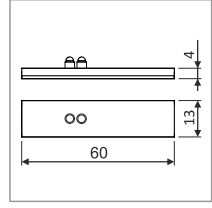

**LED SU/GR/CO dimmable, touchless switch**  
włącznik LED SU/GR/CO ściemniany bezdotykowy  
12-24V/35W

53860000

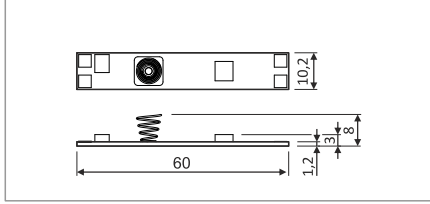

**touch LED INSIDE dimmable switch**  
włącznik dotykowy ściemniany LED INSIDE  
12-24V/36W

C5010000

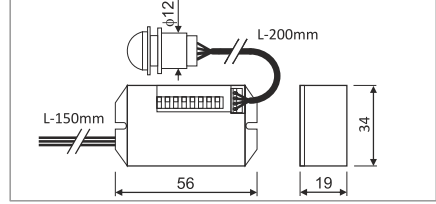

**movement sensor YCB1050**  
czujnik ruchu YCB1050  
230V/800W

85414061



## RGB lighting system

### system oświetlenia RGB

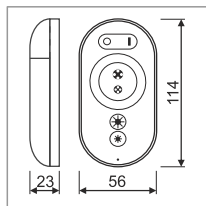
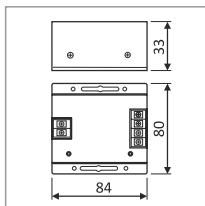

**LED RGB remote controller operates with multiple drivers.**  
Pilot może obsługiwać kilka sterowników jednocześnie.

**LED 3 channel RGB receiver**  
moduł sterujący  
LED RGB 3 kanałowy  
12V/24VDC; 216W/432W

78450000

**LED RGB remote controller**  
pilot sterujący LED RGB

78460000

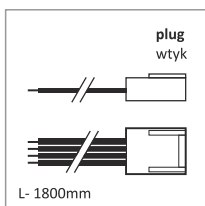

**LED RGB cable with plug**  
przewód LED RGB 1xW  
4x0,5; L-1800; MIKRO4

67060000

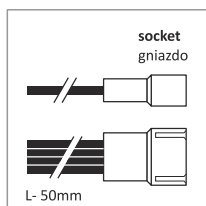

**LED RGB cable with socket**  
przewód LED RGB 1xG  
4x0,5; L-50; MIKRO4

67050000

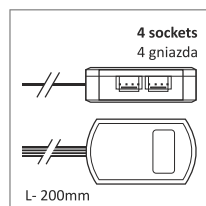

**LED RGB 4 way distribution box**  
rozdzielacz LED  
zintegrowany RGB 4xG  
4x0,5; L-200; MIKRO4

67040000

see page 9.3 for LED strips • taśmy LED patrz str. 9.3

## Vario white lighting system

### system oświetlenia Vario white

warm/cold white controllers • piloty sterujące ciepła/zimna biel

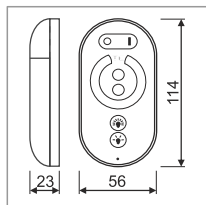
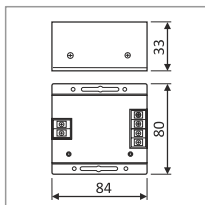

**LED remote controller operates with multiple drivers.**  
Pilot może obsługiwać kilka sterowników jednocześnie.

**LED 2 channel warm-cold receiver**  
moduł sterujący LED ciepły-zimny  
2 kanałowy  
12V/24VDC; 144W/288W

78300000

**LED remote controller warm-cold**  
pilot sterujący LED  
ciepły-zimny

78290000

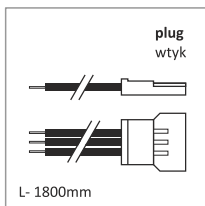

**LED cable with plug**  
przewód LED 1xW  
3x0,22; L-1800; MIKRO3

67030000

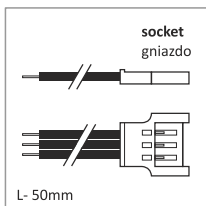

**LED cable with socket**  
przewód LED 1xG  
3x0,22; L-50; MIKRO3; 1xG

67020000

see pages 9.2-9.3 for LED strips • taśmy LED patrz str. 9.2-9.3

## LED profile slings

### zawiesia do profili LED



**SELV sling**  
zawiesie SELV  
50V; 1500

1 set = 2 pcs  
1 kpl. = 2 szt.

67120001  
67120002  
67120022

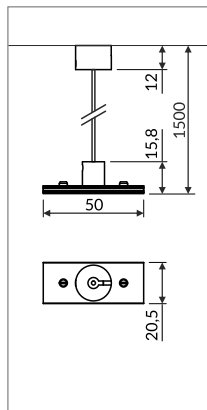

**sling for LED mounting 1500**  
zawiesie do uchwytu LED 1500

1 set = 2 pcs  
1 kpl. = 2 szt.

67140003

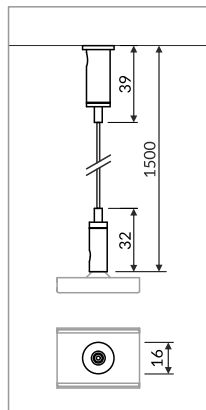

**large sling**  
zawiesie duże

1 set = 2 pcs  
1 kpl. = 2 szt.

43100003 1500mm chrome • chrom  
43110003 3000mm chrome • chrom

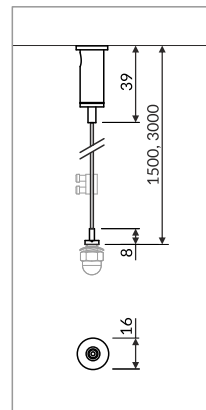

**SKB sling**  
zawiesie SKB

1 set = 1 pc  
1 kpl. = 1 szt.

67160003 1500mm chrome • chrom  
67170003 3000mm chrome • chrom

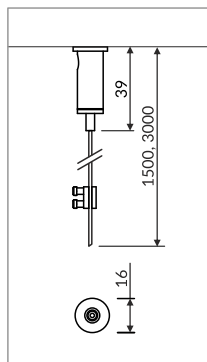

## tilted bracket for LED profiles

### uchwyt uchylny do profili LED



**tilted bracket**  
uchwyt uchylny

1 set = 2 pcs  
1 kpl. = 2 szt.

67230022 grey • szary  
67230001 white • biały  
67230002 black • czarny  
67230040 silver • srebrny

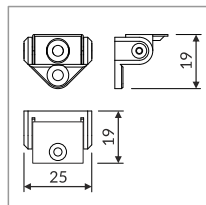

**tilted bracket compatible with cone flexible mounting plates:**  
- U5, U6, U, W, Y, Z

**cone flexible mounting plates not included**

uchwyt uchylny kompatybilny z uchwytami sprężystymi cone:  
- U5, U6, U, W, Y, Z

komplet nie zawiera uchwytów sprężystych cone

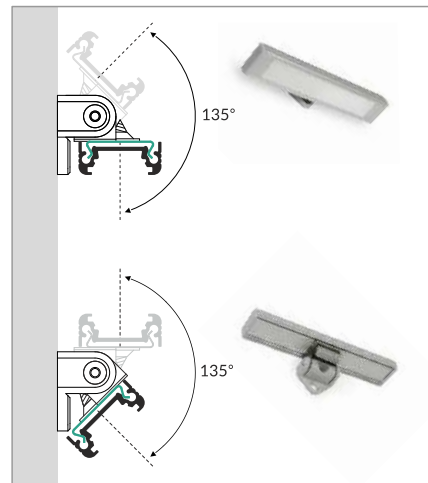

## cables, extensions, connectors

### przewody, przedłużacze, złączki

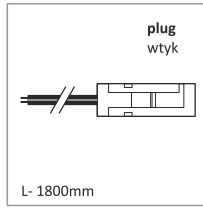

**LED cable with MINI PLUG / black**  
przewód LED MINI 1xW / czarny  
2x0,35; L-1800

85430002

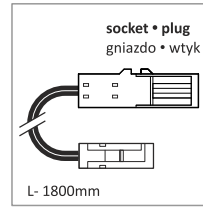

**LED extension cable with MINI socket and plug / black**  
przedłużacz LED  
MINI 1xG/1xW / czarny  
2x0,35; L-1800

85460002

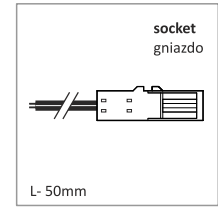

**LED cable with MINI socket / black**  
przewód LED MINI 1xG / czarny  
2x0,35; L-50

85580002

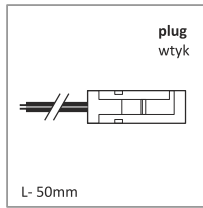

**LED cable with MINI plug / black**  
przewód LED MINI 1xW / czarny  
2x0,35; L-50

85570002

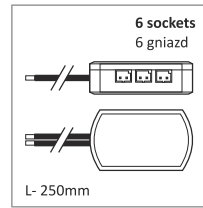

**LED 6 way MINI distribution box / black**  
rozdzielacz LED  
zintegrowany MINI 6xG / czarny  
2x0,5; L-250

85366900

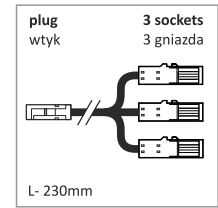

**LED cable with 3 MINI sockets and 1 plug / black**  
rozdzielacz LED  
MINI 3xG/1xW / czarny  
2x0,35; L-230

85470002

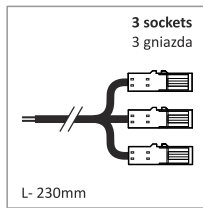

**LED cable with 3 MINI sockets / black**  
rozdzielacz LED MINI 3xG / czarny  
2x0,35; L-230

85590002

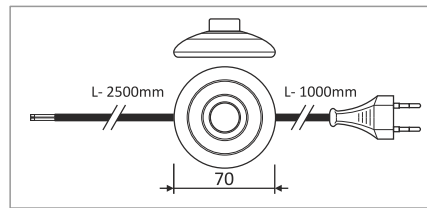

**cable with footswitch and plug / black**  
przewód z włącznikiem nożnym / czarny  
250V; 2x0,75; 2,5A; L-1000/2500

67110002

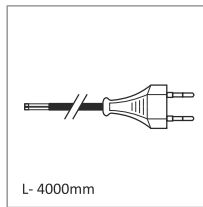

**cable with plug / black**  
przewód 1xW / czarny  
250V; 2x0,75; 2,5A; L-4000

67100002

## other accessories

### pozostałe akcesoria

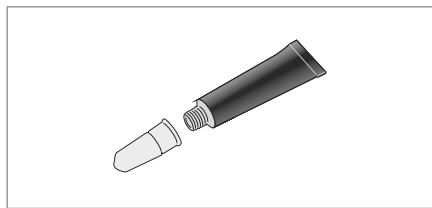

**quick-drying adhesive  
mounting gel**  
3g  
klej do mocowania w żelu

76640000



**cleaning rubber  
for anodized surfaces**  
gumka do czyszczenia  
powierzchni anodowanych

25250000

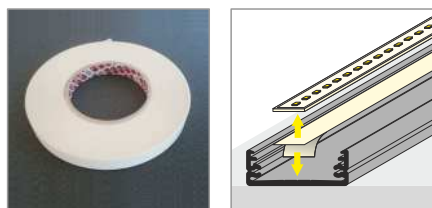

**double-sided, self adhesive,  
thermally conductive tape**  
taśma termoprzewodząca dwustronna  
15 mm x 50 m

67990000 1 roll

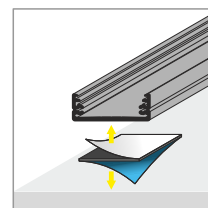
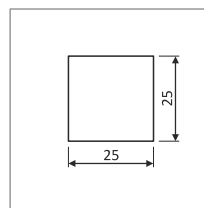
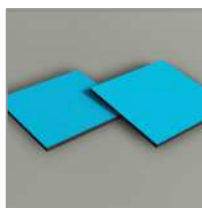

**double-sided non conductive tape**  
taśma mocująca dwustronna  
nieprzewodząca 25 mm x 25 mm

76340000

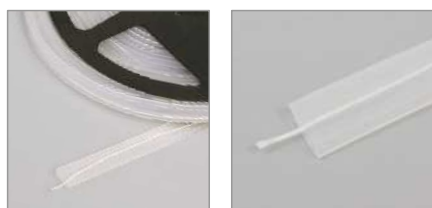

**silicone housing for 8 mm LED strip**  
osłona silikonowa do taśmy LED 8 mm  
11 mm x 5 mm x 5 mm

67980000

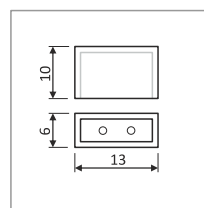
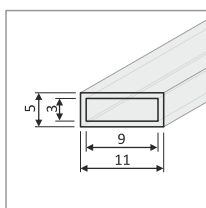

**ending for silicone housing for 8 mm LED strip**  
zaślepka do osłony silikonowej do taśmy LED 8 mm

1 set = 2 pcs (ending with hole, ending without hole)  
1 kpl. = 2 szt. (zaślepka z otworem, zaślepka bez otworu)

67970000s



**GENERAL INFORMATION**  
**INFORMACJE OGÓLNE**

**2017**

**LED profiles**  
**profile LED**

# Why LED profiles? / Dlaczego profile LED?

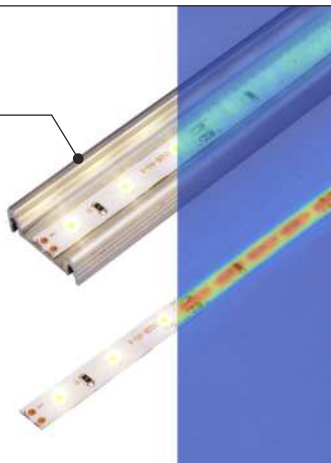
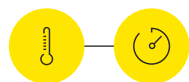

## HEAT DISSIPATION

An aluminium profile is a radiator - it dissipates heat from the LED source. Lower temperature means better operating conditions for the diodes, therefore, extension of the LED lifespan and better illumination parameters. It also translates to economic considerations - LED does not require such frequent replacement of light sources. An aluminium profile is an investment, which pays off.



Some LED sources available on the market may exceed radiation capabilities of a given aluminium profile. In order to ensure correct operation, a LED source with appropriate parameters needs to be matched to an aluminium profile.

## ODPROWADZANIE CIEPŁA

Profil aluminiowy jest radiatorem – odprowadza ciepło ze źródła LED. Niższa temperatura to lepsze warunki pracy dla diod, a tym samym przedłużenie żywotności LED i lepsze parametry świetlne. Przekłada się to również na względy ekonomiczne – LED nie wymaga tak częstych wymian źródeł światła. Profil aluminiowy to inwestycja, która się opłaca.



Niektóre źródła LED dostępne na rynku mogą przekraczać radiacyjne możliwości wybranego profilu aluminiowego. W celu zapewnienia poprawnego działania, należy dobrać do profilu aluminiowego źródło LED o odpowiednich parametrach.



## AESTHETICS / STRIP PROTECTION

An aluminium profile is a protection for a LED source against mechanical damage. The assembly is much more durable in comparison to gluing a LED strip directly to the surface. Using a profile increases aesthetics and facilitates maintaining cleanliness.

## ESTETYKA / OCHRONA TAŚMY

Profil aluminiowy stanowi zabezpieczenie źródła LED przed mechanicznym uszkodzeniem. Montaż jest znacznie trwalszy w porównaniu z przyklejeniem taśmy LED bezpośrednio do podłoża. Użycie profilu podwyższa estetykę oraz ułatwia utrzymanie czystości.

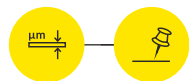

## ANODIZED COATING / COLOUR VERSIONS

In the standard TOPMET offer, aluminium LED profiles are available in 4 basic finishes:  
white painted - powder coated,  
anodised aluminium in silver colour,  
anodised aluminium in black colour,  
raw aluminium - economic version, not resistant to damage.

The most eagerly used ones are the anodized versions with a high degree of scratch resistance. The thickness of the anodic coating on all our profiles is about 15  $\mu\text{m}$ .

## ANODOWANA POWŁOKA / WERSJE KOLORYSTYCZNE

W standardowej ofercie TOPMET profile aluminiowe LED występują w 4 podstawowych wykończeniach:  
biały malowany – powłoka farby proszkowej,  
aluminium anodowane w kolorze srebrnym,  
aluminium anodowane w kolorze czarnym,  
aluminium surowe – wersja ekonomiczna, nieodporna na uszkodzenia.

Najchętniej stosowane są wersje anodowane o wysokim stopniu odporności na zarysowania. Grubość powłoki anodowej na wszystkich naszych profilach to około 15  $\mu\text{m}$ .



## ACCESSORIES

The design department is constantly working on expanding the offer with further components, which facilitate the assembly and multiply the possibilities of combinations, connections and assembly. Apart from system mounting plates, which match different profiles, many collections also have dedicated solutions for more advanced, specialist needs. The accessories for LED profiles include, i.a.: endings, covers, mounting plates, holders, extension arms, connectors, clamps, slings and many more.

## AKCESORIA

Dział projektowy stale pracuje nad wzbogaceniem oferty w kolejne komponenty, które ułatwiają montaż i wielokrotnie zwiększają możliwości kombinacji, połączeń, montażu. Poza uchwytami systemowymi, pasującymi do różnych profili, wiele kolekcji ma także dedykowane rozwiązania do bardziej zaawansowanych, specjalistycznych potrzeb. Wśród akcesoriów do profili LED są m.in.: zaślepki, klosze, uchwyty, wysięgniki, łączniki, dociski, zawieszaki i wiele innych.



EU-registered industrial design  
Wzory przemysłowe EU



Made in Poland  
Wyprodukowane w Polsce

## DESING / PRODUCTION

All profiles are unique - designed by TOPMET designers.  
All the designs are registered - legally protected throughout the European Union.  
TOPMET profiles, accessories and luminaires are manufactured in Poland.

## PROJEKT / PRODUKCJA

Wszystkie profile są unikatowe – zaprojektowane przez projektantów TOPMET.  
Wszystkie wzory są zarejestrowane – chronione prawnie na terenie całej Unii Europejskiej.  
Profile, akcesoria i oprawy TOPMET wyprodukowane są w Polsce.



# Why is it worth to choose LED technology? Dlaczego warto wybrać technologię LED?

## ECONOMY / EKONOMIA

Comparison of light sources of similar lumen output / Porównanie źródeł światła o zbliżonej wartości strumienia świetlnego



traditional bulb  
żarówka tradycyjna  
power / moc: 100 W  
price / cena: 0,78 €



halogen source  
żarówka halogenowa  
power / moc: 70 W  
price / cena: 1,19 €



LED source  
źródło LED  
power / moc: 11,5 W  
price / cena: 9,50 €

### Energy / Energia

Watts necessary to obtain lumen output of 1000 lm / Ilość watów potrzebna do uzyskania światła o strumieniu 1000 lm

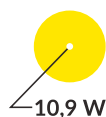
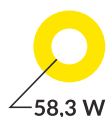
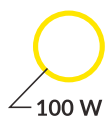

### Lifespan / Żywotność

Time in hours for which one light source will glow until the lumen output decreases by 20 - 30% compared to the initial value

Czas podany w godzinach, w którym będzie świecić jedna żarówka zanim wartość strumienia świetlnego zmniejszy się o 20 - 30% w stosunku do wartości początkowej



### Expenses / Wydatki

Amount and costs of worn-out light sources during one LED source lifespan / Ilość i koszt zużytych źródeł światła w okresie żywotności jednego źródła LED

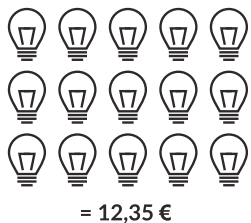

Daily costs of energy if the light glows for 8h\* / Koszt energii z jednego dnia przy świetle zapalonym przez 8 h\*

0,11 €

0,07 €

0,01 €

Costs of energy throughout the LED source lifespan\* / Koszt energii z całego okresu żywotności źródła LED\*

203,58 €

142,50 €

23,41 €

### Total cost / Suma kosztów

of operation and light source prices\*\* / eksploatacji oraz ceny źródła światła\*\*

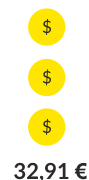

How much can you save by using a LED light source? \*\* / Ile można zaoszczędzić stosując źródło LED? \*\*



In relation to traditional bulb  
W stosunku do tradycyjnej żarówki  
**183,01 €**



In relation to halogen source  
W stosunku do żarówki halogenowej  
**118,55 €**

\* assuming the rate per 1 kWh at a level of: 0,14 € / przy założeniu stawki za 1 kWh na poziomie 0,14 €

\*\* throughout the LED source lifespan / w całym okresie żywotności źródła LED



## ECOLOGY / EKOLOGIA



What we should pay particular attention to is the impact of everyday use devices on the natural environment.

And so, lights using the LED technology are biodegradable, have a longer lifespan compared to traditional sources and consume less energy. Moreover, LED does not contain mercury.

less source replacements = less waste reaching the environment

To, na co powinniśmy zwrócić największą uwagę, to oddziaływanie na środowisko naturalne urządzeń codziennego użytku. I tak, światła wykorzystujące technologię LED są biodegradowalne, mają większą żywotność w stosunku do tradycyjnych źródeł oraz zużywają mniej energii. Ponadto LED nie zawiera rtęci.

mniej wymian źródeł = mniej odpadów trafiających do środowiska







**SALES SUPPORT**  
**WSPARCIE SPRZEDAŻY**

# 2017

**LED profiles**  
**profile LED**

# Sales support / Wsparcie sprzedaży

LED PROFILES SAMPLE BOX



LED PROFILES SAMPLE CASE



LED profiles / profile LED



VARIO30



big profiles / duże profile



## LED PROFILES SAMPLE BOARD



## LED PROFILES DISPLAY STAND

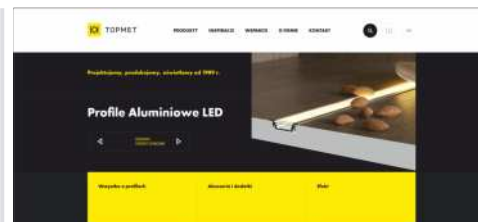

[www.topmet.co.uk](http://www.topmet.co.uk)  
[www.topmet.pl](http://www.topmet.pl)



professional consultancy service  
profesjonalne doradztwo



LED luminares catalogues  
karty katalogowe opraw LED

General terms and conditions available  
on website:

<http://www.topmet.pl/en/tc/>

Ogólne warunki gwarancji dostępne  
są na stronie:

<http://www.topmet.pl/pl/polityka-prywatnosci/>

## marking of covers fitting the sockets in the profile

oznaczenia kloszy pasujących do gniazd w profilu



## marking of holders fitting the profile

oznaczenia uchwytów pasujących do profilu



## profile with Slick socket

profil z gniazdem Slick



## LED profile categories

kategorie profili LED



**surface**  
nawierzchniowy



**recessed**  
wpustowy



**corner**  
kątowy



**special application**  
specjalny



**glass application**  
do szkła

## pictograms

piktogramy



**maximum LED strip width**  
maksymalna szerokość taśmy LED



**note**  
uwaga



**assembly adhesive**  
klej montażowy



**available in stock**  
dostępny na magazynie



**made in Poland**  
wyprodukowane w Polsce



**EU-registered industrial design**  
wzory przemysłowe EU

**SURFACE  
NAWIERZCHNIOWE**

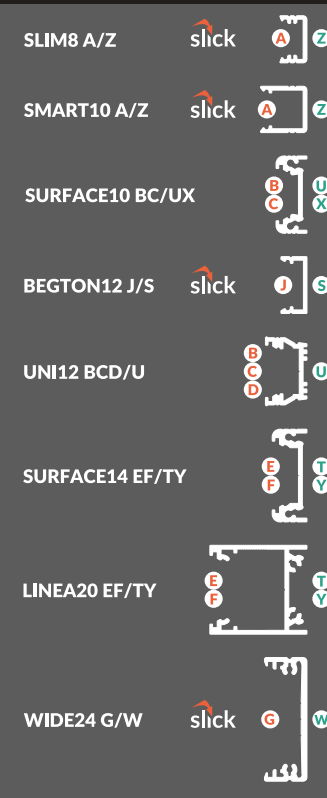

**SPECIAL APPLICATION  
SPECJALNE**

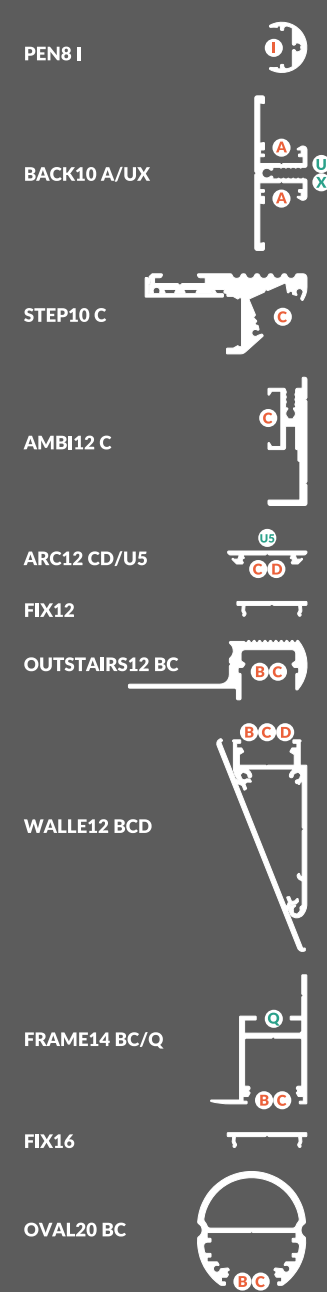

**RECESSED  
WPUSTOWE**

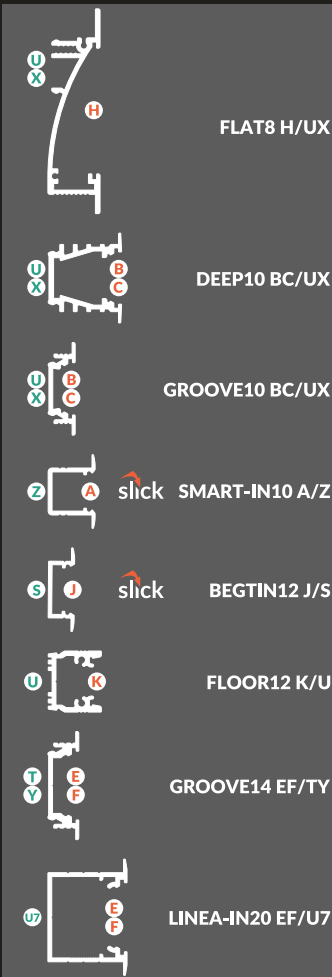

**CORNER  
KĄTOWE**

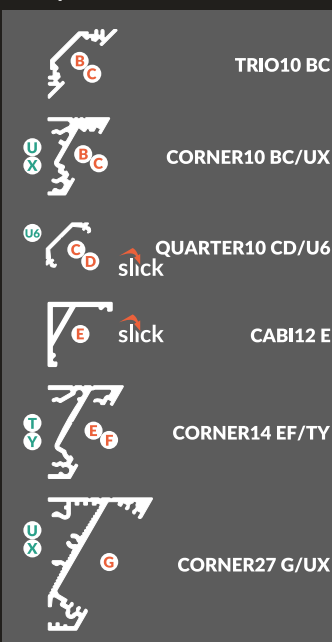

**GLASS APPLICATION  
DO SZKŁA**

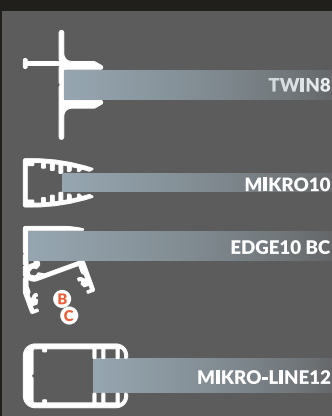



Made in Poland  
Wyprodukowane w Polsce



EU-registered industrial design  
Wzory przemysłowe EU

**TOPMET LIGHT Kłosowicz Wiśniewski i Wspólnik Sp. j. ADDRESS: Ostrowska 354, 61-312 Poznań, POLAND  
tel. +48 61 87 27 500, fax. +48 61 87 27 518 [biuro@topmet.pl](mailto:biuro@topmet.pl), [www.topmet.pl](http://www.topmet.pl)**

The catalogue is not an offer under Polish Civil Code regulations. Colours of particular products may vary slightly from colours shown in pictures. The dimensions given are approximate and can not be a reason for complaint. TOPMET Company reserves the right to make technical changes.

Katalog nie stanowi oferty w myśl przepisów Kodeksu Cywilnego. Aktualną ofertę firmy stanowi cennik. Kolory poszczególnych produktów mogą się nieznacznie różnić od kolorów prezentowanych na zdjęciach. Podane wymiary są wymiarami orientacyjnymi i nie mogą stanowić podstawy reklamacji. Firma TOPMET zastrzega sobie prawo do wprowadzania zmian technicznych.

catalogue designer • proj. folderu: M. Kędziora, A. Szafran 03.2017. photo • fot.: K. Samulska, A. Szafran, S. Wawrzyn, L. Wesołowski, A. Wierdak  
visualisations • wizualizacje: M. Kędziora, A. Szafran, P. Woś

Distributor / Dystrybutor

LED profiles  
Profile LED